

feeling









FEELING ESTOFADOS

CRIADA POR LAERCIO LUIS COELHO, A FEELING É UMA EMPRESA ESPECIALIZADA EM ALTA DECORAÇÃO, QUE RESPIRA INOVAÇÃO E DESIGN E CRIA CADA SOFÁ COMO SE FOSSE ÚNICO. COM PAIXÃO, COMPROMETIMENTO E QUALIDADE.

“BUSCAMOS A EXCELÊNCIA NO CONFORTO E AS ÚLTIMAS TENDÊNCIAS EM DESIGN PARA ATENDER OS CLIENTES MAIS EXIGENTES DO NOSSO SEGMENTO. A ORIGINALIDADE FEELING ESTÁ NA BUSCA CONSTANTE PELO NOSSO JEITO DE ADERIR ÀS TENDÊNCIAS E CRIAR PEÇAS QUE SÃO VERDADEIROS SONHOS DE CONSUMO.”

A close-up photograph of a brown leather sofa. The leather has a rich, warm tone and a prominent, cracked texture, suggesting a high-quality, aged material. The lighting is soft and directional, highlighting the contours and the grain of the leather. The background is blurred, showing more of the sofa's structure and a light-colored fabric.

EXCELENCIA E SOFISTICAÇÃO *desde 1992*



STUDIO FEELING

Com uma trajetória marcada com produtos para alta-decoração, o Studio Feeling tem em seu repertório, sofás, poltronas, puffs e camas contemporâneas e um design de excelência que alia o conforto e as tendências para criar produtos que são verdadeiros sonhos de consumo e ícones de inovação e design.



MAURICIO BOMFIM

Tem no seu DNA o autodidatismo e a paixão pelo design. Estudou Design de interiores e atua no desenvolvimento de projetos nas mais diversas áreas. Sempre com um olhar sintonizado com o que há de melhor no design e nas artes nacionais e internacionais. Acredita que não pode faltar em um bom projeto uma relação interativa com o cliente, cheia de afeto, humor e observação.



PEDRO MENDES

Formado em Design pela Universidade Mackenzi, Pedro é um dos designers mais conceituados do Brasil. Na busca constante pelo conforto aliado à estética, o designer possui traços atemporais e assina muitos de nossos produtos com destreza.

DESIGNERS



FERNANDA POLUCHA E MARIANA ZUANA

Designers de produto, trabalham com criação de móveis, objetos decorativos e espaços de exposição. O perfil de seus projetos é marcado pela exploração formal e viabilidade fabril, de acordo com o potencial de cada empresa para as quais trabalham.



DANIELA FERRO

Designer de produto formada pela UFPR. Peças direcionadas ao mercado de alta decoração, que são fabricadas dentro de padrões de excelência e fidelidade ao projeto. Sonhos de consumo e ícones de inovação e design.



SÉRGIO BATISTA

Forte nome na indústria moveleira nacional, onde é expoente há mais de 25 anos. Design flexível e fluidez industrial marcam o seu trabalho. Sérgio atua exclusivamente no design de varejo onde é conhecido por um feeling apurado e por criar produtos contemporâneos e sofisticados.

S O F Á S





MEMORY

Design MAURICIO BOMFIM



ASSISTA O
CONCEITO
DESTE
PRODUTO



DESCRIÇÃO DO PRODUTO

ASSENTO: RETRÁTIL - D33 + HR + ULTRACEL + FIBRA

ENCOSTO: FIXO - D20 SOFT + HR + FIBRA

ENCOSTO FINO: FIXO - D20 SOFT

ALMOFADA DE ENCOSTO C/ ROLINHO: SOLTA - HR + FIBRA

ALMOFADA DE RIM: SOLTA - FIBRA

OPCIONAIS: ASSENTO ELÉTRICO OU MANUAL.

USB NO BRAÇO.

OBSERVAÇÕES: LIMITE MÁXIMO DE 1,30M PARA O ASSENTO EM MEDIDAS ESPECIAIS.

DESCRIPTION OF PRODUCT

SEAT: RETRACTABLE - D33 + HR + ULTRACEL + FIBER

BACKREST: FIXED - D20 SOFT + HR + FIBER

THIN BACKREST: FIXED - D20 SOFT

BACKREST CUSHION WITH ROLL CUSHION: LOOSE - HR + FIBER

LUMBAR CUSHION: LOOSE - FIBER

OPTIONAL: ELECTRIC OR MANUAL SEAT. USB IN THE ARMREST.

NOTES: MAXIMUM LENGTH OF 1.30M FOR THE SEAT IN SPECIAL MEASURES

DESCRIPCIÓN DEL PRODUCTO

ASIENTO: RETRÁCTIL - D33 + HR + ULTRACEL + FIBRA

RESPALDO: FIJO - D20 SOFT + HR + FIBRA

RESPALDO ESTRECHO: FIJO - D20 SOFT

ALMOHADA DE RESPALDO CON ROLLITO: SUELTO - HR + FIBRA

ALMOHADA ESPALDA BAJA: SUELTO - FIBRA

OPCIONALES: ASIENTO ELÉCTRICO O MANUAL. USB EN EL

REPOSABRAZOS.

OBSERVACIONES: ANCHURA MÁXIMA DE 1,30 M PARA EL ASIENTO EN MEDIDAS ESPECIALES.

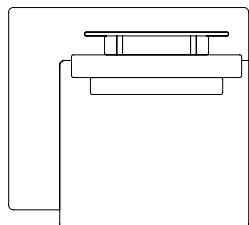

Configurações de 1 assento com 1 braço

Módulo 115 - 1ass(90) + 1br(25) + 1alm/enc(90x44) c/rol(60x10) + 1alm/rim(70x30)

Módulo 125 - 1ass(100) + 1br(25) + 1alm/enc(90x44) c/rol(60x10) + 1alm/rim(70x30)

Módulo 135 - 1ass(110) + 1br(25) + 1alm/enc(90x44) c/rol(60x10) + 1alm/rim(70x30)

Módulo 145 - 1ass(120) + 1br(25) + 1alm/enc(90x44) c/rol(60x10) + 1alm/rim(70x30)

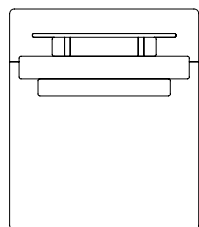

Configurações de 1 assento com 1 braço

Módulo 90 - 1ass(90) + 1alm/enc(90x44) c/rol(60x10) + 1alm/rim(70x30)

Módulo 100 - 1ass(100) + 1alm/enc(90x44) c/rol(60x10) + 1alm/rim(70x30)

Módulo 110 - 1ass(110) + 1alm/enc(90x44) c/rol(60x10) + 1alm/rim(70x30)

Módulo 120 - 1ass(120) + 1alm/enc(90x44) c/rol(60x10) + 1alm/rim(70x30)

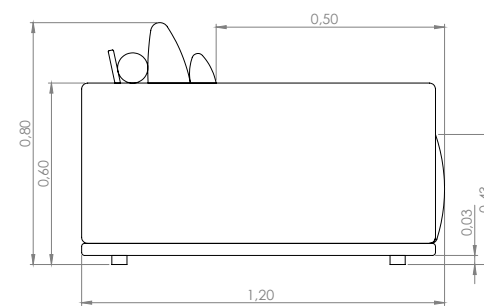

Módulo fechado

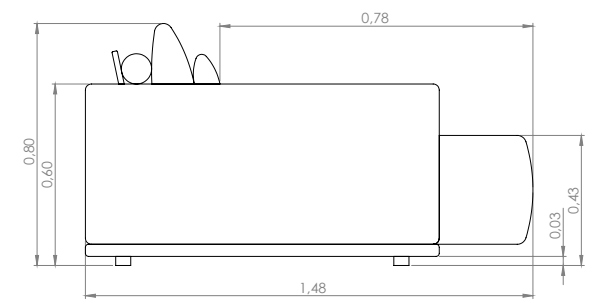

Módulo aberto

SPACE

Design MAURICIO BOMFIM



ASSISTA O
CONCEITO
DESTE
PRODUTO



DESCRIÇÃO DO PRODUTO

ASSENTO: FIXO - PERCINTA + D33 + HR + D26 ULTRACEL + FIBRA.

ENCOSTO: FIXO - D20 SOFT + D23 HIPER + FIBRA.

ALMOFADA DE ENCOSTO: SOLTA - D23 HIPER + D26 ULTRACEL + ALGODÃO + FIBRA.

ALMOFADA DECORATIVA: SOLTA - D26 ULTRACEL + ALGODÃO + FIBRA.

ROLINHO: SOLTO - D33 + FIBRA

PÉS: PINTURA ELETROSTÁTICA - CHUMBO, MARROM OU BLACK.

OBSERVAÇÕES: AS ALMOFADAS DE RIM POSSUEM A MEDIDA 10CM MENOR QUE A ALMOFADA DE ENCOSTO.

OPCIONAIS: ALMOFADA GRANDE (TAMANHO DO ASSENTO) OU ALMOFADA MÉDIA (10CM MAIOR QUE A ALMOFADA PADRÃO).

DESCRIPTION OF PRODUCT

SEAT: FIXED - ELASTIC BELT + D33 + HR + D26 ULTRACEL + FIBER.

BACKREST: FIXED - D20 SOFT + D23 HYPER + FIBER.

BACKREST CUSHION: LOOSE - D23 HYPER + D26 ULTRACEL + COTTON + FIBER.

DECORATIVE CUSHION: LOOSE - D26 ULTRACEL + COTTON + FIBER.

ROLL CUSHION: LOOSE - D33 + FIBER

NOTE: THE LUMBAR CUSHION IS 10CM SMALLER THAN THE BACKREST CUSHION.

OPTIONAL: BIG CUSHION (SEAT SIZE) OR MEDIUM CUSHION (10CM LARGER THAN THE STANDARD CUSHION).

DESCRIPCIÓN DEL PRODUCTO

ASIENTO: FIJO - CINTURÓN ELÁSTICO + D33 + HR + D26 ULTRACEL + FIBRA.

RESPALDO: FIJO - D20 SUAVE + D23 HIPER + FIBRA.

ALMOHADA DE RESPALDO: SUELTA - D23 HÍPER + D26 ULTRACEL + ALGODÓN + FIBRA.

ALMOHADA DECORATIVA: SUELTA - D26 ULTRACEL + ALGODÓN + FIBRA.

ALMOHADA ROLLITO: SUELTO - D33 + FIBRA

OBSERVACIONES: LAS ALMOHADAS DE ESPALDA BAJA TIENEN LA MEDIDA 10CM MÁS PEQUEÑA QUE LA ALMOHADA DE RESPALDO.

OPCIONALES: ALMOHADA GRANDE (TAMAÑO DEL ASIENTO) O ALMOHADA MEDIANA (10 CM MÁS GRANDE QUE ALMOHADA ESTÁNDAR).

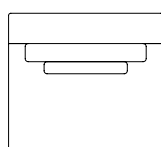

Configurações com 1 assento e sem braço

Módulo 75 - 1ass(75) + 1alm/enc(42x47) + 1alm/rim(32x37)

Módulo 90 - 1ass(90) + 1alm/enc(52x47) + 1alm/rim(42x37)

Módulo 105 - 1ass(105) + 1alm/enc(62x47) + 1alm/rim(52x37)

Módulo 120 - 1ass(120) + 1alm/enc(72x47) + 1alm/rim(62x37)

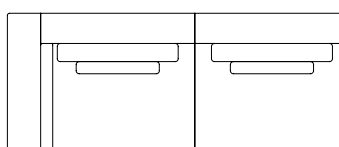

Configurações com 2 assentos e 1 braço

Módulo 172 - 2ass(75) + 1br(22) + 2alm/enc(42x47) + 2alm/rim(32x37) + 1rol(66x12)

Módulo 202 - 2ass(90) + 1br(22) + 2alm/enc(52x47) + 2alm/rim(42x37) + 1rol(66x12)

Módulo 232 - 2ass(105) + 1br(22) + 2alm/enc(62x47) + 2alm/rim(52x37) + 1rol(66x12)

Módulo 262 - 2ass(120) + 1br(22) + 2alm/enc(72x47) + 2alm/rim(62x37) + 1rol(66x12)

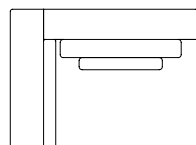

Configurações com 1 assento e 1 braço

Módulo 97 - 1ass(75) + 1br(22) + 1alm/enc(42x47) + 1alm/rim(32x37) + 1rol(66x12)

Módulo 112 - 1ass(90) + 1br(22) + 1alm/enc(52x47) + 1alm/rim(42x37) + 1rol(66x12)

Módulo 127 - 1ass(105) + 1br(22) + 1alm/enc(62x47) + 1alm/rim(52x37) + 1rol(66x12)

Módulo 142 - 1ass(120) + 1br(22) + 1alm/enc(72x47) + 1alm/rim(62x37) + 1rol(66x12)

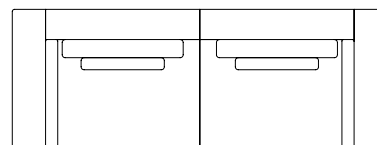

Configurações com 2 assentos e 2 braços

Módulo 194 - 2ass(75) + 2br(22) + 2alm/enc(42x47) + 2alm/rim(32x37) + 2rol(66x12)

Módulo 224 - 2ass(90) + 2br(22) + 2alm/enc(52x47) + 2alm/rim(42x37) + 2rol(66x12)

Módulo 254 - 2ass(105) + 2br(22) + 2alm/enc(62x47) + 2alm/rim(52x37) + 2rol(66x12)

Módulo 284 - 2ass(120) + 2br(22) + 2alm/enc(72x47) + 2alm/rim(62x37) + 2rol(66x12)

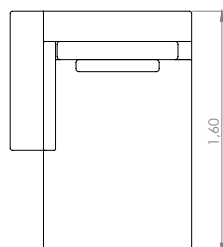

Configurações de Chaise

Chaise 127 - 1ass(105) + 1br(22) + 1alm/enc(62x47) + 1alm/rim(52x37) + 1rol(66x12)

Chaise 142 - 1ass(120) + 1br(22) + 1alm/enc(72x47) + 1alm/rim(62x37) + 1rol(66x12)

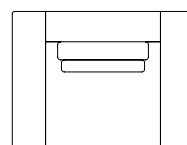

Configuração de Poltrona

Poltrona 119 - 1ass(75) + 2br(22) + 1alm/enc(42x47) + 1alm/rim(32x37)

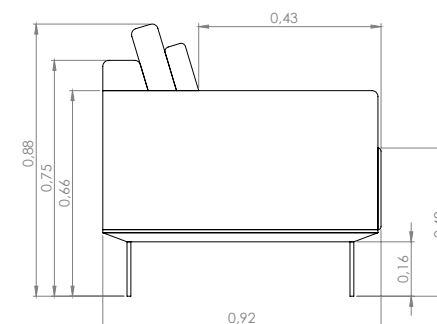

COSTUME

Design MAURICIO BOMFIM



ASSISTA O
CONCEITO
DESTE
PRODUTO



DESCRIÇÃO DO PRODUTO

ASSENTO: FIXO - HR + D33 + ULTRACEL + FIBRA

ENCOSTO: FIXO - D20 SOFT + D33 + HR + FIBRA

ENCOSTO SOLTO: SOLTO - D33 + FIBRA

ALMOFADA DE ENCOSTO: SOLTA - FIBRA

MESA: LÂMINA NATURAL - CARVALHO NATURAL, CARVALHO EBANIZADO, CARVALHO LINEN OU NOGUEIRA.

PÉS: PINTURA ELETROSTÁTICA - CHUMBO, MARROM OU BLACK.

OPCIONAIS: CARREGADOR USB NO BRAÇO

OBSERVAÇÕES: UMA PARTE DA MESA É SOBREPOSTA AO ASSENTO, APENAS 12CM ULTRAPASSAM A LARGURA DO ASSENTO.

DESCRIPTION OF PRODUCT

SEAT: FIXED - HR + D33 + ULTRACEL + FIBER

BACKREST: FIXED - D20 SOFT + D33 + HR + FIBER

LOOSE BACKREST: LOOSE - D33 + FIBER

BACKREST CUSHION: LOOSE - FIBER

TABLE: NATURAL VENEER - NATURAL OAK, EBANIZED OAK, OAK LINEN OR WALNUT

FOOT: ELECTROSTATIC PAINTING - LEAD, BROWN OR BLACK.

OPTIONAL: USB CHARGER ON THE ARMREST

NOTE A PART OF THE TABLE IS OVERLAPPED TO THE SEAT, ONLY 12CM EXCEED THE WIDTH OF THE SEAT.

DESCRIPCIÓN DEL PRODUCTO

ASIENTO: FIJO - HR + D33 + ULTRACEL + FIBRA

RESPALDO: FIJO - D20 SOFT + D33 + HR + FIBRA

RESPALDO SUELTO: SUELTO - D33 + FIBRA

ALMOHADA DEL RESPALDO: SUELTO - FIBRA

MESA: CHAPA NATURAL - ROBLE NATURAL, ROBLE EBANIZADO, ROBLE LINO O NOGAL

PIES: PINTURA ELECTROSTÁTICA - PLOMO, MARRÓN O NEGRO.

OPCIONAL: CARGADOR USB EN EL BRAZO

OBSERVACIONES: UNA PARTE DE LA MESA SE SOBREPONE A EL ASIENTO, SÓLO 12 CM SUPERAN LA ANCHURA DEL MISMO.

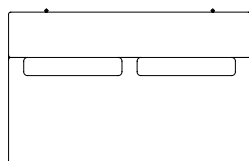

Configurações com 1 assento e sem braço

Módulo 100 - 1ass(100) + 1alm/enc(65x50)

Módulo 120 - 1ass(120) + 1alm/enc(65x50)

Módulo 140 - 1ass(140) + 2alm/enc(65x50)

Módulo 160 - 1ass(160) + 2alm/enc(65x50)

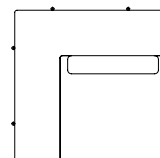

Configuração de Canto

Canto 100 - 1ass(73) + 1br/enc(27) + 1alm/enc(55x50)

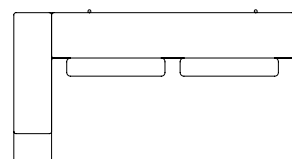

Configurações com 1 assento e 1 braço

Módulo 125 - 1ass(100) + 1br(25) + 1alm/enc(65x50)

Módulo 145 - 1ass(120) + 1br(25) + 1alm/enc(65x50)

Módulo 165 - 1ass(140) + 1br(25) + 2alm/enc(65x50)

Módulo 185 - 1ass(160) + 1br(25) + 2alm/enc(65x50)

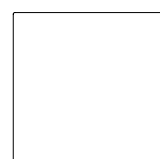

Configurações de Puff

Puff canto - 1puff(100x100)

Puff 110 - 1puff(110x100)

Puff 120 - 1puff(120x100)

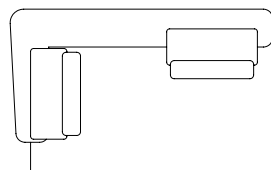

Configurações com 1 assento e 1 mesa

Módulo 112 - 1ass(100) + 1mesa(25) + 1alm/enc(55x50) + 1enc/solto(60x24)

Módulo 132 - 1ass(120) + 1mesa(25) + 2alm/enc(55x50) + 2enc/solto(60x24)

Módulo 152 - 1ass(140) + 1mesa(25) + 2alm/enc(55x50) + 2enc/solto(60x24)

Módulo 172 - 1ass(160) + 1mesa(25) + 2alm/enc(55x50) + 2enc/solto(60x24)

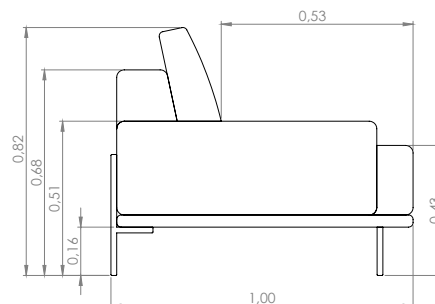

MOROSO

Design MAURICIO BOMFIM



ASSISTA O
CONCEITO
DESTE
PRODUTO



DESCRIÇÃO DO PRODUTO

ASSENTO: RETRÁTIL - PERCINTA + HR + D33 + ULTRACEL + FIBRA.

ENCOSTO: RECLINÁVEL - HR + ULTRACEL + FIBRA.

ALMOFADA DE ENCOSTO: SOLTA - FIBRA SILICONADA + FIBRA.

MESA: PINTURA ELETROSTÁTICA - CHUMBO, MARRON OU BLACK.

PÉ: IMBUÍIA.

OPCIONAIS: MESA.

ASSENTO/ENCOSTO ELÉTRICO OU MANUAL.

OBSERVAÇÕES: LIMITE MÁXIMO DE 1,30M PARA O ASSENTO EM MEDIDAS ESPECIAIS.

DESCRIPTION OF PRODUCT

SEAT: RETRACTABLE - ELASTIC BELT + HR + D33 + ULTRACEL + FIBER.

BACKREST: RECLINABLE - HR + ULTRACEL + FIBER.

BACKREST CUSHION: LOOSE - SILICONIZED FIBER + FIBER.

TABLE: ELECTROSTATIC PAINTING - LEAD, BROWN OR BLACK.

FOOT: IMBUÍIA.

OPTIONAL: TABLE. ELECTRIC OR MANUAL SEAT/BACKREST.

NOTES: MAXIMUM LENGTH OF 1.30M FOR THE SEAT IN SPECIAL MEASURES.

DESCRIPCIÓN DEL PRODUCTO

ASIENTO: RETRÁCTIL - PERCUSIÓN + HR + D33 + ULTRACEL + FIBRA.

RESPALDO: RECLINABLE - HR + ULTRACEL + FIBRA.

ALMOHADA DEL RESPALDO: SUELTO - FIBRA SILICONADA + FIBRA.

MESA: PINTURA ELECTROSTÁTICA - PLOMO, MARRÓN O NEGRO.

PIE: IMBUÍIA.

OPCIONALES: MESA. ASIENTO/RESPALDO ELÉCTRICO O MANUAL

OBSERVACIONES: ANCHURA MÁXIMA DE 1,30 M PARA EL ASIENTO EN MEDIDAS ESPECIALES.

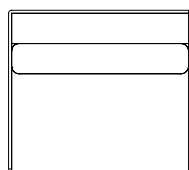

Configurações com 1 assento e 1 braço fino

Módulo 90 - 1ass(87) + 1br(3) + 1alm/enc(87x48)

Módulo 100 - 1ass(97) + 1br(3) + 1alm/enc(97x48)

Módulo 110 - 1ass(107) + 1br(3) + 1alm/enc(107x48)

Módulo 120 - 1ass(117) + 1br(3) + 1alm/enc(117x48)

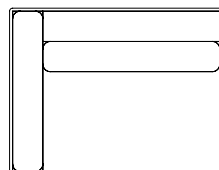

Configurações com 1 assento e 1 braço largo

Módulo 110 - 1ass(87) + 1br(23) + 1alm/enc(87x48)

Módulo 120 - 1ass(97) + 1br(23) + 1alm/enc(97x48)

Módulo 130 - 1ass(107) + 1br(23) + 1alm/enc(107x48)

Módulo 140 - 1ass(117) + 1br(23) + 1alm/enc(117x48)

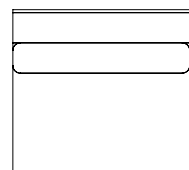

Configurações com 1 assento e sem braço

Módulo 87 - 1ass(87) + 1alm/enc(87x48)

Módulo 97 - 1ass(97) + 1alm/enc(97x48)

Módulo 107 - 1ass(107) + 1alm/enc(107x48)

Módulo 117 - 1ass(117) + 1alm/enc(117x48)



Configuração de Mesa

Mesa 15 - 1mesa(15x44)

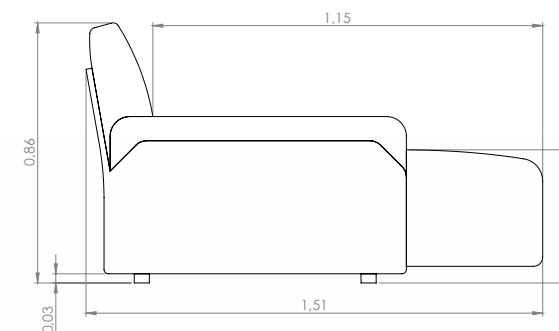
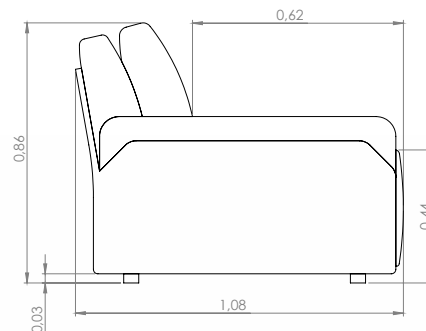

SENSATION

Design MAURICIO BOMFIM



ASSISTA O
CONCEITO
DESTE
PRODUTO

DESCRIÇÃO DO PRODUTO

ASSENTO: FIXO - HR + D33 + ULTRACEL + FIBRA

ENCOSTO: FIXO - HR + D20 SOFT + FIBRA

ENCOSTO FINO: FIXO - D20 SOFT

ALMOFADA DE ENCOSTO: SOLTA - FIBRA

ALMOFADA DE RIM: SOLTA - FIBRA

ALMOFADA DECORATIVA: SOLTA - FIBRA

MESA: REVESTIDA: COURO OU TECIDO

PÉS: PINTURA ELETROSTÁTICA - CHUMBO, MARROM OU BLACK.

OPCIONAIS: CARREGADOR USB NO BRAÇO

OBSERVAÇÕES: MÓDULO CURVO: DEVIDO A SUA CURVATURA, A LARGURA DO ASSENTO SERÁ MENOR QUE A LARGURA TOTAL DO MÓDULO. NÃO DISPONÍVEL EM MEDIDAS ESPECIAIS. NÃO DISPONÍVEL EM COURÍSSMO.

OS PÉS LATERAIS ACRESCEM 2CM NA LARGURA TOTAL DE CADA MÓDULO RETO. SOMENTE OS MÓDULOS COM MESA, TEM ENCOSTO FINO.

DESCRIPTION OF PRODUCT

SEAT: BACKREST: FIXED - HR + D20 SOFT + FIBER

THIN BACKREST: FIXED - D20 SOFT

LUMBAR CUSHION: LOOSE - FIBER

DECORATIVE CUSHION: LOOSE - FIBER

TABLE: COATED: LEATHER OR FABRIC

FOOT: ELECTROSTATIC PAINTING - LEAD, BROWN OR BLACK.

OPTIONAL: USB CHARGER ON THE ARMREST

NOTES: CURVED MODULE: DUE TO ITS CURVATURE, THE SEAT WIDTH WILL BE SMALLER THAN THE MODULE'S TOTAL WIDTH.

NOT AVAILABLE IN SPECIAL MEASURES.

NOT AVAILABLE IN LEATHER.

SIDE FOOT ADDS 2CM TO THE OVERALL WIDTH OF EACH STRAIGHT MODULE.

DESCRIPCIÓN DEL PRODUCTO

ASIENTO: FIJO - HR + D33 + ULTRACEL + FIBRA

RESPALDO: FIJO - HR + D20 SOFT + FIBRA

RESPALDO ESTRECHO: FIJO - D20 SOFT

ALMOHADA ESPALDA BAJA: SUELTO - FIBRA

ALMOHADA DECORATIVA: SUELTO - FIBRA

MESA: REVESTIMIENTO: PIEL O TELA

PIES: PINTURA ELECTROSTÁTICA - PLOMO, MARRÓN O NEGRO

OPCIONAL: CARGADOR USB EN EL BRAZO

OBSERVACIONES: MÓDULO CURVO: DEBIDO A SU CURVATURA, LA ANCHURA DEL ASIENTO SERÁ MÁS PEQUEÑA QUE LA ANCHURA TOTAL DEL MÓDULO.

NO DISPONIBLE EN MEDIDAS ESPECIALES.

NO DISPONIBLE EN PIEL.

LOS PIES LATERALES AÑADEN 2 CM A LA ANCHURA TOTAL DE CADA MÓDULO RECTO.

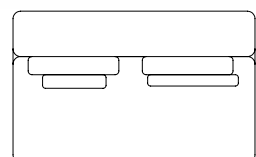
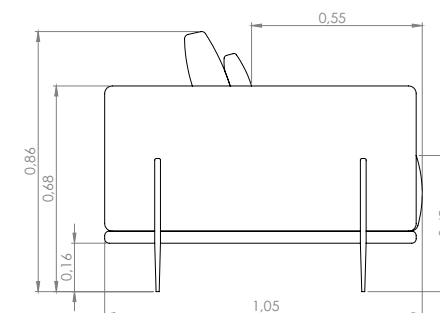

Configurações com 1 assento e sem braço (mód reto)

Módulo reto 95 - 1ass(95) + 1alm/enc(60x50) + 1alm/dec(42x42)

Módulo reto 115 - 1ass(115) + 1alm/enc(60x50) + 1alm/dec(42x42)

Módulo reto 135 - 1ass(135) + 1alm/enc(60x50) + 1alm/enc(60x40) + 1alm/dec(42x42) + 1alm/rim(60x27)

Módulo reto 155 - 1ass(155) + 1alm/enc(60x50) + 1alm/enc(60x40) + 1alm/dec(42x42) + 1alm/rim(60x27)

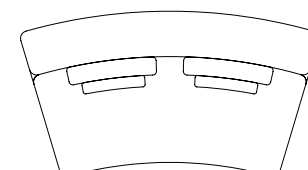

Configurações com 1 assento e sem braço (mód curvo)

Módulo curvo 180 - 1ass(135) + 2alm/enc(60x50) + 2alm/dec(42x42)

Módulo curvo 200 - 1ass(155) + 2alm/enc(60x50) + 2alm/dec(42x42)

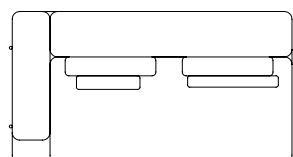

Configurações com 1 assento e 1 braço (mód reto)

Módulo reto 122 - 1ass(95) + 1br(25) + 1alm/enc(60x50) + 1alm/dec(42x42)

Módulo reto 142 - 1ass(115) + 1br(25) + 1alm/enc(60x50) + 1alm/dec(42x42)

Módulo reto 162 - 1ass(135) + 1br(25) + 1alm/enc(60x50) + 1alm/enc(60x40) + 1alm/dec(42x42) + 1alm/rim(60x27)

Módulo reto 182 - 1ass(155) + 1br(25) + 1alm/enc(60x50) + 1alm/enc(60x40) + 1alm/dec(42x42) + 1alm/rim(60x27)

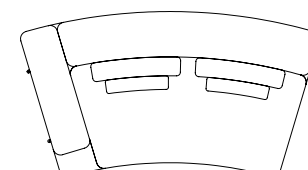

Configurações com 1 assento e 1 braço (mód curvo)

Módulo curvo 180 - 1ass(110) + 1br(25) + 2alm/enc(60x50) + 2alm/dec(42x42)

Módulo curvo 200 - 1ass(130) + 1br(25) + 2alm/enc(60x50) + 2alm/dec(42x42)

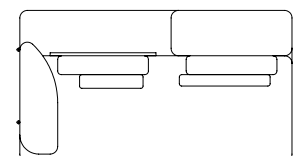

Configurações com 1 assento e 1 mesa (mód reto)

Módulo reto 162 - 1ass(135) + 1mesa(25) + 1alm/enc(60x50) + 1alm/enc(60x40) + 1alm/dec(42x42) + 1alm/rim(60x27)

Módulo reto 182 - 1ass(155) + 1mesa(25) + 1alm/enc(60x50) + 1alm/enc(60x40) + 1alm/dec(42x42) + 1alm/rim(60x27)

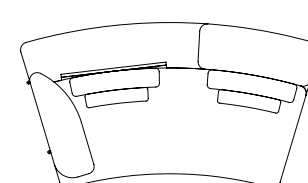

Configurações com 1 assento e 1 mesa (mód curvo)

Módulo curvo 180 - 1ass(135) + 1mesa(25) + 2alm/enc(60x50) + 2alm/dec(42x42)

Módulo curvo 200 - 1ass(155) + 1mesa(25) + 2alm/enc(60x50) + 2alm/dec(42x42)

FRAGMENTO

Design MAURICIO BOMFIM



ASSISTA O
CONCEITO
DESTE
PRODUTO



DESCRIÇÃO DO PRODUTO

ASSENTO: FIXO - HR + ULTRACEL + FIBRA

ENCOSTO: FIXO - HR + ULTRACEL + D20 SOFT + FIBRA

OBSERVAÇÕES: CONFIGURAÇÃO COM 1 ASSENTO MENOR E SEM BRAÇO E CONFIGURAÇÃO DE PUFF: NÃO ESTÃO DISPONÍVEIS EM MEDIDAS ESPECIAIS. CONFIGURAÇÕES COM 1 ASSENTO MAIOR E SEM BRAÇO: DISPONÍVEL EM MEDIDA ESPECIAL, A MESMA SERÁ FEITA NA PARTE COM ENCOSTO. PRODUTO INDISPONÍVEL EM COURÍSSIMO.

DESCRIPTION OF PRODUCT

SEAT: FIXED - HR + ULTRACEL + FIBER

BACKREST: FIXED - HR + ULTRACEL + D20 SOFT + FIBER

NOTES: CONFIGURATION WITH 1 SMALLER SEAT WITH NO ARMREST AND PUFF CONFIGURATION: NOT AVAILABLE IN SPECIAL MEASURES. CONFIGURATIONS WITH 1 LARGER SEAT AND NO ARM: AVAILABLE IN SPECIAL MEASURES, IT WILL BE APPLIED TO THE PIECE WITH BACKREST. PRODUCT UNAVAILABLE IN LEATHERETTE.

DESCRIPCIÓN DEL PRODUCTO

ASIENTO: FIJO - HR + ULTRACEL + FIBRA

RESPALDO: FIJO - HR + ULTRACEL + D20 SOFT + FIBRA

OBSERVACIONES: CONFIGURACIÓN CON 1 ASIENTO MÁS PEQUEÑO Y SIN DESCANSABRAZOS Y CONFIGURACIÓN PUFF: NO DISPONIBLE EN MEDIDAS ESPECIALES.

CONFIGURACIÓN CON 1 ASIENTO MÁS GRANDE Y SIN BRAZO: DISPONIBLE EN MEDIDAS ESPECIALES, LO MISMO SE HARÁ EN LA PARTE CON RESPALDO. PRODUCTO NO DISPONIBLE EN POLIPIEL.

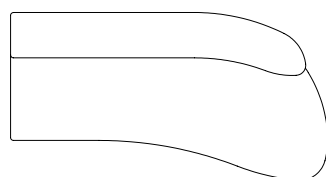

Configurações de 1 assento maior

Módulo 140 - 1ass(140)

Módulo 160 - 1ass(160)

Módulo 180 - 1ass(180)

Módulo 210 - 1ass(210)

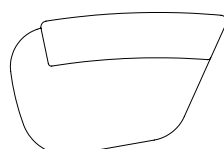

Configuração de 1 assento menor

Módulo 140 - 1ass(140)

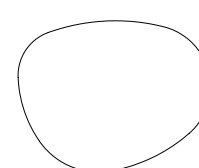

Configuração de Puff

Puff 128 - 1puff(128x100)

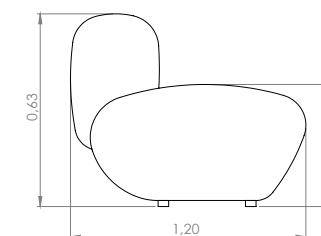

HIATO

Design MAURICIO BOMFIM



ASSISTA O
CONCEITO
DESTE
PRODUTO

DESCRIÇÃO DO PRODUTO

ASSENTO: FIXO - HR + D33 + ULTRACEL + FIBRA

ENCOSTO: FIXO - HR + FIBRA

ENCOSTO FINO: FIXO - D20 SOFT

ALMOFADA DE ENCOSTO: SOLTA - FIBRA

ALMOFADA DECORATIVA: SOLTA - FIBRA

ROLINHO: FIXO - HR + FIBRA

ALÇA ROLINHO: PINTURA ELETROSTÁTICA - CHUMBO, MARROM OU BLACK.

BASE: PINTURA ELETROSTÁTICA - CHUMBO, MARROM OU BLACK.

PÉS: PINTURA ELETROSTÁTICA - CHUMBO, MARROM OU BLACK.

OPCIONAIS: CARREGADOR USB NO BRAÇO.

ROLINHO.

OBSERVAÇÕES: AS CONFIGURAÇÕES DE CHAISE TERÃO UMA COSTURA ADICIONAL NA PARTE SUPERIOR DO ASSENTO, DEVIDO AS DIMENSÕES DO TECIDO.

DESCRIPTION OF PRODUCT

SEAT: FIXED - HR + D33 + ULTRACEL + FIBER

BACKREST: FIXED - HR + FIBER

THIN BACKREST: FIXED - D20 SOFT

BACKREST CUSHION: LOOSE - FIBER

DECORATIVE CUSHION: LOOSE - FIBER

ROLL CUSHION: FIXED - HR + FIBER

ROLL CUSHION HANDLE: ELECTROSTATIC PAINT - LEAD, BROWN OR BLACK.

BASE: ELECTROSTATIC PAINTING - LEAD, BROWN OR BLACK.

FEET: ELECTROSTATIC PAINT - LEAD, BROWN OR BLACK.

OPTIONAL: USB CHARGER IN THE ARMREST. ROLL CUSHION.

NOTES: THE CHAISE CONFIGURATIONS WILL HAVE AN ADDITIONAL SEAM ON THE TOP OF THE SEAT, DUE TO THE DIMENSIONS OF THE FABRIC.

DESCRIPCIÓN DEL PRODUCTO

ASIENTO: FIJO - HR + D33 + ULTRACEL + FIBRA

RESPALDO: FIJO - HR + FIBRA

RESPALDO ESTRECHO: FIJO - D20 SOFT

ALMOHADA DE RESPALDO: SUELTO - FIBRA

ALMOHADA DECORATIVA: SUELTA - FIBRA

ROLLITO: FIJO - HR + FIBRA

MANEJO DEL ROLLITO: PINTURA ELETROSTÁTICA - PLOMO, MARRÓN O NEGRO.

BASE: PINTURA ELETROSTÁTICA - PLOMO, MARRÓN O NEGRO.

PIES: PINTURA ELETROSTÁTICA - PLOMO, MARRÓN O NEGRO.

OPCIONALES: CARGADOR USB EN EL DESCANSABRAZO. ROLLITO.

OBSERVACIONES: LAS CONFIGURACIONES DE LA CHAISE TENDRÁN UNA COSTURA ADICIONAL EN LA PARTE SUPERIOR DEL ASIENTO, DEBIDO A LAS DIMENSIONES DE LA TELA.

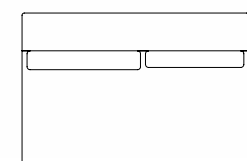
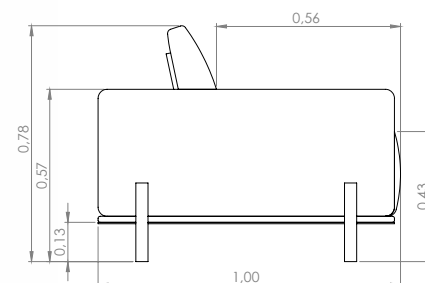
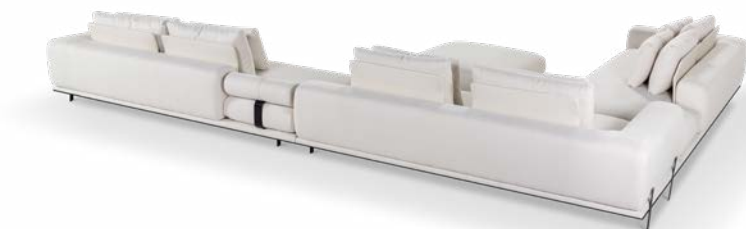

Configurações com 1 assento

Módulo 90 - 1ass (90) + 1alm/enc(75x40) + 1alm/dec(65x35)
 Módulo 110 - 1ass (110) + 1alm/enc(75x40) + 1alm/dec(65x35)
 Módulo 140 - 1ass (140) + 1alm/enc(75x40) + 1alm/dec(65x35)
 Módulo 170 - 1ass (170) + 2alm/enc(75x40) + 2alm/dec(65x35)
 Módulo 200 - 1ass (200) + 2alm/enc(75x40) + 2alm/dec(65x35)
 Módulo 230 - 1ass (230) + 2alm/enc(75x40) + 2alm/dec(65x35)

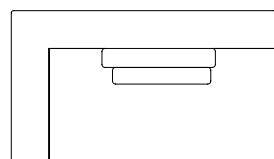

Configurações com 1 assento e 1 braço

Módulo 110 - 1ass(85) + 1br(25) + 1alm/enc(75x40) + 1alm/dec(65x35)
 Módulo 140 - 1ass(115) + 1br(25) + 1alm/enc(75x40) + 1alm/dec(65x35)
 Módulo 170 - 1ass(145) + 1br(25) + 2alm/enc(70x40) + 2alm/dec(65x35)
 Módulo 200 - 1ass(175) + 1br(25) + 2alm/enc(75x40) + 2alm/dec(65x35)
 Módulo 230 - 1ass(205) + 1br(25) + 2alm/enc(75x40) + 2alm/dec(65x35)

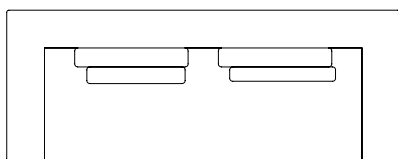

Configurações com 1 assento e 2 braços

Módulo 200 - 1ass(150) + 2br(25) + 2alm/enc(70x40) + 2alm/dec(65x35)
 Módulo 230 - 1ass(180) + 2br(25) + 2alm/enc(75x40) + 2alm/dec(65x35)
 Módulo 260 - 1ass(210) + 2br(25) + 2alm/enc(75x40) + 2alm/dec(65x35)
 Módulo 280 - 1ass(230) + 2br(25) + 3alm/enc(75x40) + 3alm/dec(65x35)
 Módulo 300 - 1ass(250) + 2br(25) + 3alm/enc(75x40) + 3alm/dec(65x35)

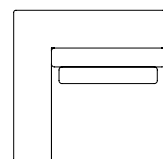

Configuração de Canto

Canto 100 - 1ass(75) + 1br/enc(25) + 1alm/enc(75x40) + 1alm/dec(65x35)

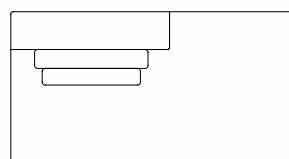

Configurações com 1 assento e 1 puff

Módulo 170 - 1ass (110) + 1puff(60) + 1alm/enc(70x40) + 1alm/dec(65x35)
 Módulo 200 - 1ass (140) + 1puff(60) + 2alm/enc(70x40) + 2alm/dec(65x35)
 Módulo 230 - 1ass (170) + 1puff(60) + 2alm/enc(70x40) + 2alm/dec(65x35)
 Módulo 260 - 1ass (200) + 1puff(60) + 2alm/enc(70x40) + 2alm/dec(65x35)

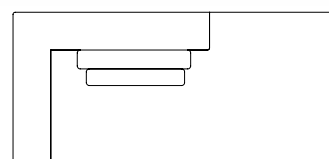

Configurações com 1 assento, 1 puff e 1 braço

Módulo 170 - 1ass (85) + 1puff(60) + 1br(25) + 1alm/enc(70x40) + 1alm/dec(65x35)
 Módulo 200 - 1ass (115) + 1puff(60) + 1br(25) + 1alm/enc(70x40) + 1alm/dec(65x35)
 Módulo 230 - 1ass (145) + 1puff(60) + 1br(25) + 1alm/enc(70x40) + 2alm/dec(65x35)
 Módulo 260 - 1ass (175) + 1puff(60) + 1br(25) + 2alm/enc(70x40) + 2alm/dec(65x35)

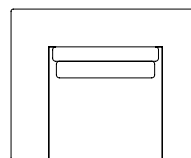

Configuração de Poltrona

Poltrona 125 - 1ass(75) + 2br(25) + 1alm/enc(70x40) + 1alm/dec(65x35)

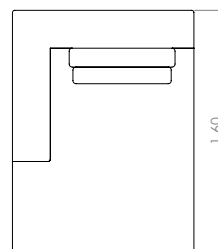

Configurações de Chaise

Chaise 120 - 1ass(95) + 1br(25) + 1alm/enc(75x40) + 1alm/dec(65x35)
 Chaise 150 - 1ass(125) + 1br(25) + 1alm/enc(75x40) + 1alm/dec(65x35)

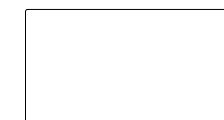

Configurações de Puff

Puff 100 - 1puff(100x75)
 Puff 120 - 1puff(120x75)
 Puff 140 - 1puff(140x75)
 Puff canto - 1puff(100x100)

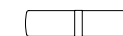

Configuração de Rolinho

Rolinho 55 - 1ro(55x17)

CAPITÓLIO

Design MAURICIO BOMFIM



ASSISTA O
CONCEITO
DESTE
PRODUTO

DESCRIÇÃO DO PRODUTO

ASSENTO: FIXO - D33 + D26 ULTRACEL + FIBRA.

ENCOSTO: FIXO - D33 + FIBRA.

ALMOFADA DE ENCOSTO: SOLTA - PENA DE GANSO.

ALMOFADA DE RIM: SOLTA - PENA DE GANSO.

ALMOFADA DECORATIVA: SOLTA - PENA DE GANSO.

PÉ/BASE: PINTURA ELETROSTÁTICA - CHUMBO, MARROM OU BLACK.

ENCOSTO/SOLTO: REVESTIDO

MESA: LÂMINA NATURAL - CARVALHO NATURAL, CARVALHO EBANIZADO, CARVALHO LINEN OU NOGUEIRA.

OPCIONAIS: CARREGADOR USB NO BRAÇO(25) (CABO DE ALIMENTAÇÃO PARA TOMADA PADRÃO DO BRASIL OU EUA).

OBSERVAÇÕES: A MESA CONTÉM 38CM DE LARGURA, PORÉM, APLICADA AO PRODUTO ELA OCUPA UM ESPAÇO DE 28CM NA CONFIGURAÇÃO FINAL. O ENCOSTO SOLTO NÃO PODERÁ SER REVESTIDO NO RECOURO.

DESCRIPTION OF PRODUCT

SEAT: FIXED - D33 + D26 ULTRACEL + FIBER.

BACKREST: FIXED - D33 + FIBER.

BACKREST CUSHION: LOOSE - GOOSE FEATHER.

LUMBAR CUSHION: LOOSE - GOOSE FEATHER.

DECORATIVE CUSHION: LOOSE - GOOSE FEATHER.

FOOT/BASE: ELECTROSTATIC PAINT - LEAD, BROWN OR BLACK.

LOOSE BACKREST: COATED

TABLE: NATURAL VENEER - NATURAL OAK, EBANIZED OAK, OAK LINEN OR WALNUT.

OPTIONAL: USB CHARGER IN THE ARMREST (25) (POWER CORD TO STANDARD BRAZIL OR US OUTLET).

NOTE: THE TABLE IS 38CM WIDTH, HOWEVER, APPLIED TO THE PRODUCT IT TAKES UP A SPACE OF 28CM IN THE FINAL CONFIGURATION. THE LOOSE BACKREST CANNOT BE COVERED IN LEATHER.

DESCRIPCIÓN DEL PRODUCTO

ASIENTO: FIJO - D33 + D26 ULTRACEL + FIBRA.

RESPALDO: FIJO - D33 + FIBRA.

ALMOHADA DE RESPALDO: SUELTO - PLUMA DE OCA.

ALMOHADA ESPALDA BAJA: SUELTO - PLUMA DE OCA.

ALMOHADA DECORATIVA: SUELTA - PLUMA DE OCA.

PIE/ BASE: PINTURA ELECTROSTÁTICA - PLOMO, MARRÓN O NEGRO.

RESPALDO/SUELA: RECUBIERTO.

MESA: CHAPA NATURAL - ROBLE NATURAL, ROBLE EBONIZADO, ROBLE LINO O NOGAL.

OPCIONAL: CARGADOR USB EN EL BRAZO (25) (CABLE DE ALIMENTACIÓN A ENCHUFE ESTÁNDAR EN BRASIL O EE. UU.).

OBSERVACIONES: LA MESA TIENE 38CM DE ANCHO, SIN EMBARGO, APLICADA AL PRODUCTO OCUPA UN ESPACIO DE 28CM EN LA CONFIGURACIÓN FINAL. EL RESPALDO SUELTO NO PUEDE ESTAR CUBIERTO DE PIEL.



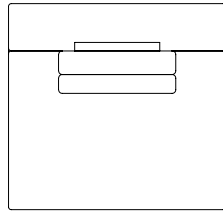

Configurações com 1 assento e sem braço

Módulo 95 - 1ass(95) + 1alm/enc(65x50) + 1alm/rim(65x45) + 1enc/solto(50x50)
 Módulo 105 - 1ass(105) + 1alm/enc(65x50) + 1alm/rim(65x45) + 1enc/solto(50x50)
 Módulo 115 - 1ass(115) + 1alm/enc(65x50) + 1alm/rim(65x45) + 1enc/solto(50x50)

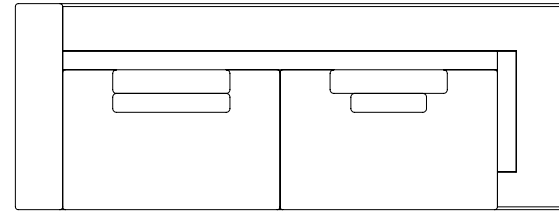

Configurações com 2 assentos, 1 braço alto, 1 braço baixo e 1 mesa

Módulo 253 - 2ass(95) + 1br(10) + 1br(25) + 1mesa(38) + 2alm/enc(65x50) + 1alm/rim(65x45) + 1alm/dec(40x40)
 Módulo 273 - 2ass(105) + 1br(10) + 1br(25) + 1mesa(38) + 2alm/enc(65x50) + 1alm/rim(65x45) + 1alm/dec(40x40)
 Módulo 293 - 2ass(115) + 1br(10) + 1br(25) + 1mesa(38) + 2alm/enc(65x50) + 1alm/rim(65x45) + 1alm/dec(40x40)

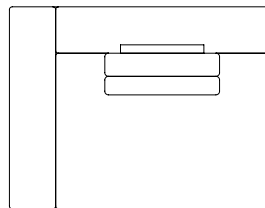

Configurações com 1 assento e 1 braço baixo

Módulo 120 - 1ass(95) + 1br(25) + 1alm/enc(65x50) + 1alm/rim(65x45) + 1enc/solto(50x50)
 Módulo 130 - 1ass(105) + 1br(25) + 1alm/enc(65x50) + 1alm/rim(65x45) + 1enc/solto(50x50)
 Módulo 140 - 1ass(115) + 1br(25) + 1alm/enc(65x50) + 1alm/rim(65x45) + 1enc/solto(50x50)

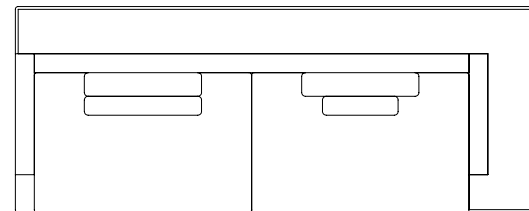

Configurações com 2 assentos, 2 braços altos e 1 mesa

Módulo 238 - 2ass(95) + 2br(10) + 1mesa(38) + 2alm/enc(65x50) + 1alm/rim(65x45) + 1alm/dec(40x40)
 Módulo 258 - 2ass(105) + 2br(10) + 1mesa(38) + 2alm/enc(65x50) + 1alm/rim(65x45) + 1alm/dec(40x40)



Configurações de almofadas

Alm/enc(65x50)
 Alm/rim(65x45)
 Alm/dec(40x40)

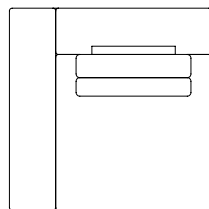

Configuração de canto

Canto 105 - 1ass(80) + 1br/enc(25) + 1alm/enc(65x50) + 1alm/rim(65x45) + 1enc/solto(50x50)

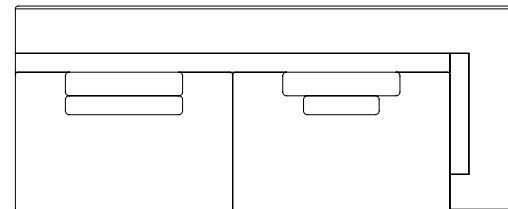

Configurações com 2 assentos, 1 braço alto e 1 mesa

Módulo 228 - 2ass(95) + 1br(10) + 1mesa(38) + 2alm/enc(65x50) + 1alm/rim(65x45) + 1alm/dec(40x40)
 Módulo 248 - 2ass(105) + 1br(10) + 1mesa(38) + 2alm/enc(65x50) + 1alm/rim(65x45) + 1alm/dec(40x40)
 Módulo 268 - 2ass(115) + 1br(10) + 1mesa(38) + 2alm/enc(65x50) + 1alm/rim(65x45) + 1alm/dec(40x40)

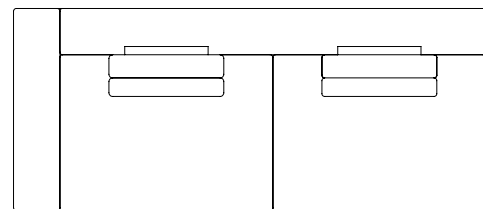
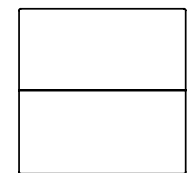

Configurações com 2 assentos e 1 braço baixo

Módulo 215 - 2ass(95) + 1br(25) + 2alm/enc(65x50) + 2alm/rim(65x45) + 2enc/solto(50x50)
 Módulo 235 - 2ass(105) + 1br(25) + 2alm/enc(65x50) + 2alm/rim(65x45) + 2enc/solto(50x50)
 Módulo 255 - 2ass(115) + 1br(25) + 2alm/enc(65x50) + 2alm/rim(65x45) + 2enc/solto(50x50)

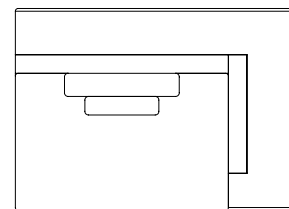

Configurações com 1 assento, 1 braço alto e 1 mesa

Módulo 133 - 1ass(95) + 1br(10) + 1mesa(38) + 1alm/enc(65x50) + 1alm/dec(40x40)
 Módulo 143 - 1ass(105) + 1br(10) + 1mesa(38) + 1alm/enc(65x50) + 1alm/dec(40x40)
 Módulo 153 - 1ass(115) + 1br(10) + 1mesa(38) + 1alm/enc(65x50) + 1alm/dec(40x40)

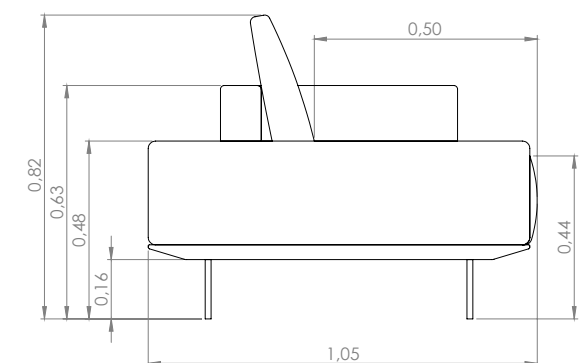



CIPÓ

Design MAURICIO BOMFIM



ASSISTA O
CONCEITO
DESTE
PRODUTO

DESCRIÇÃO DO PRODUTO

ASSENTO: FIXO - HR + D33 + MOLA + D26 ULTRACEL + FIBRA.

ENCOSTO: FIXO - HR + D20 SOFT + FIBRA.

ALMOFADA DE ENCOSTO: SOLTA - PENA DE GANSO.

ALMOFADA DE RIM: SOLTA - D20 SOFT + D26 ULTRACEL + FIBRA.

BASE: PINTURA ELETROSTÁTICA - CHUMBO, MARRON OU BLACK.

MESA: LÂMINA NATURAL - CARVALHO NATURAL, CARVALHO EBANIZADO, CARVALHO LINEN OU NOGUEIRA.

OBSERVAÇÕES: A MESA CONTÉM 22CM DE LARGURA, PORÉM, APLICADA AO PRODUTO ELA OCUPA UM ESPAÇO DE 10CM NA CONFIGURAÇÃO FINAL. O PRODUTO DEVERÁ SER COMPOSTO POR UM CONJUNTO DE DOIS MÓDULOS.

DESCRIPTION OF PRODUCT

SEAT: FIXED - HR + D33 + SPRING + D26 ULTRACEL + FIBER.

BACKREST: FIXED - HR + D20 SOFT + FIBER.

BACKREST CUSHION: LOOSE - GOOSE FEATHER.

DECORATIVE CUSHION: LOOSE - D20 SOFT + D26 ULTRACEL + FIBER.

BASE: ELECTROSTATIC PAINTING - LEAD, BROWN OR BLACK.

TABLE: NATURAL VENEER - NATURAL OAK, EBANIZED OAK, OAK LINEN OR WALNUT

NOTE: THE TABLE IS 22CM WIDTH, HOWEVER, APPLIED TO THE PRODUCT IT TAKES UP A 10CM SPACE IN THE FINAL CONFIGURATION. THE PRODUCT SHOULD BE COMPOSED OF A SET OF TWO MODULES.

DESCRIPCIÓN DEL PRODUCTO

ASIENTO: FIJO - HR + D33 + RESORTE + D26 ULTRACEL + FIBRA.

RESPALDO: FIJO - HR + D20 SUAVE + FIBRA.

ALMOHADA DE RESPALDO: SUELTO - PLUMA DE OCA.

ALMOHADA DECORATIVA: SUELTO - D20 SOFT + D26 ULTRACEL + FIBRA.

BASE: PINTURA ELECTROSTÁTICA - PLOMO, MARRÓN O NEGRO.

MESA: CHAPA NATURAL - ROBLE NATURAL, ROBLE EBANIZADO, ROBLE LINO O NOGAL.C16

OBSERVACIONES: LA MESA TIENE 22CM DE ANCHO, SIN EMBARGO, APLICADA AL PRODUCTO OCUPA UN ESPACIO DE 10CM EN LA CONFIGURACIÓN FINAL. EL PRODUCTO DEBE ESTAR COMPUESTO POR UN CONJUNTO DE DOS MÓDULOS.

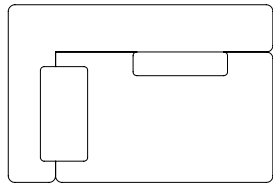

Configurações com 1 assento e 1 braço/encosto

Módulo 110 - 1ass(85) + 1br/enc(25) + 1alm/enc(65x50) + 1alm/rim(56x27)

Módulo 120 - 1ass(95) + 1br/enc(25) + 1alm/enc(65x50) + 1alm/rim(56x27)

Módulo 130 - 1ass(105) + 1br/enc(25) + 1alm/enc(65x50) + 1alm/rim(56x27)

Módulo 140 - 1ass(115) + 1br/enc(25) + 1alm/enc(65x50) + 1alm/rim(56x27)



Configurações de Almofadas

Alm/enc(65x50)

Alm/rim(56x27)

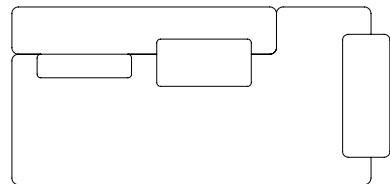

Configurações com 1 assento, 1 puff e 1 mesa

Módulo 170 - 1ass(110) + 1puff(50) + 1mesa(22) + 1alm/enc(65x50) + 1alm/rim(56x27)

Módulo 180 - 1ass(120) + 1puff(50) + 1mesa(22) + 1alm/enc(65x50) + 1alm/rim(56x27)

Módulo 190 - 1ass(130) + 1puff(50) + 1mesa(22) + 1alm/enc(65x50) + 1alm/rim(56x27)

Módulo 200 - 1ass(140) + 1puff(50) + 1mesa(22) + 1alm/enc(65x50) + 1alm/rim(56x27)

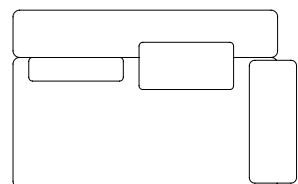
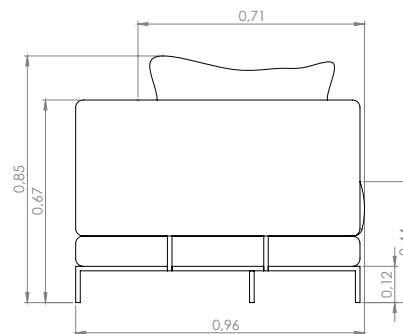

Configurações com 1 assento e 1 mesa

Módulo 120 - 1ass(110) + 1mesa(22) + 1alm/enc(65x50) + 1alm/rim(56x27)

Módulo 130 - 1ass(120) + 1mesa(22) + 1alm/enc(65x50) + 1alm/rim(56x27)

Módulo 140 - 1ass(130) + 1mesa(22) + 1alm/enc(65x50) + 1alm/rim(56x27)

Módulo 150 - 1ass(140) + 1mesa(22) + 1alm/enc(65x50) + 1alm/rim(56x27)



Configurações de Puff

Puff 90 - 1ass(90x75)

Puff 100 - 1ass(100x75)

Puff 110 - 1ass(110x75)

Puff 120 - 1ass(120x75)



PARACATU

Design MAURICIO BOMFIM



ASSISTA O
CONCEITO
DESTE
PRODUTO

DESCRIÇÃO DO PRODUTO

ASSENTO: FIXO - PERCINTA + HR + D33 + D26 ULTRACEL + FIBRA.

ENCOSTO: FIXO - D20 SOFT + FIBRA.

ENCOSTO FINO: FIXO - HR.

ALMOFADA DE ENCOSTO: SOLTA - PENA DE GANSO

ALMOFADA DECORATIVA: SOLTA - PENA DE GANSO.

ROLINHO: SOLTO - HR + FIBRA.

PÉ: PINTURA ELETROSTÁTICA - CHUMBO, MARROM OU BLACK.

OBSERVAÇÕES: REVESTIMENTO DO ENCOSTO FINO INDISPONÍVEL EM RECOURO.

DESCRIPTION OF PRODUCT

SEAT: FIXED - ELASTIC BELT + HR + D33 + D26 ULTRACEL + FIBER.

BACKREST: FIXED - D20 SOFT + FIBER.

THIN BACKREST: FIXED - HR.

BACKREST CUSHION: LOOSE - GOOSE FEATHER

DECORATIVE CUSHION: LOOSE - GOOSE FEATHER.

ROLL CUSHION: LOOSE - HR + FIBER.

FOOT: ELECTROSTATIC PAINTING - LEAD, BROWN OR BLACK.

NOTE: THIN BACKREST COVERING UNAVAILABLE IN LEATHER.

DESCRIPCIÓN DEL PRODUCTO

ASIENTO: FIJO - CINTURÓN ELÁSTICO + HR + D33 + D26 ULTRACEL + FIBRA.

RESPALDO: FIJO - D20 SUAVE + FIBRA.

RESPALDO: FIJO - HR.

ALMOHADA DE RESPALDO: SUELTO - PLUMA DE OCA

ALMOHADA DECORATIVA: SUELTA - PLUMA DE OCA.

ALMOHADA ROLLITO: SUELTO - HR + FIBRA.

PIE: PINTURA ELECTROSTÁTICA - PLOMO, MARRÓN O NEGRO.

OBSERVACIONES: REVESTIMIENTO FINO DEL RESPALDO NO DISPONIBLE EN PIEL.



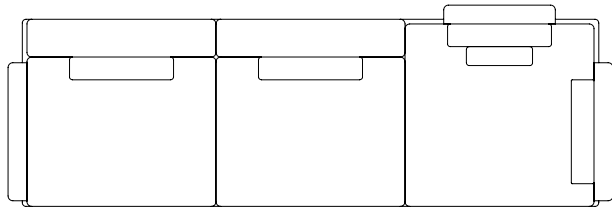

Configurações com 2 assentos, 1 assento com encosto fino e 2 braços

Módulo 254 - 2ass(80) + 1ass/enc/fino(80) + 2br(7) + 3alm/enc(65x50) + 1alm/dec(40x40) + 1rol(62x12)
 Módulo 284 - 2ass(90) + 1ass/enc/fino(90) + 2br(7) + 3alm/enc(65x50) + 1alm/dec(40x40) + 1rol(62x12)
 Módulo 314 - 2ass(100) + 1ass/enc/fino(100) + 2br(7) + 3alm/enc(65x50) + 1alm/dec(40x40) + 1rol(62x12)
 Módulo 344 - 2ass(110) + 1ass/enc/fino(110) + 2br(7) + 3alm/enc(65x50) + 1alm/dec(40x40) + 1rol(62x12)

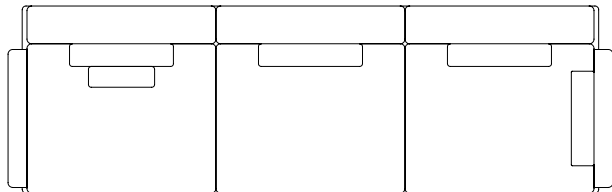

Configurações com 3 assentos e 2 braços

Módulo 254 - 3ass(80) + 2br(7) + 3alm/enc(65x50) + 1alm/dec(40x40) + 1rol(62x12)
 Módulo 284 - 3ass(90) + 2br(7) + 3alm/enc(65x50) + 1alm/dec(40x40) + 1rol(62x12)
 Módulo 314 - 3ass(100) + 2br(7) + 3alm/enc(65x50) + 1alm/dec(40x40) + 1rol(62x12)
 Módulo 344 - 3ass(110) + 2br(7) + 3alm/enc(65x50) + 1alm/dec(40x40) + 1rol(62x12)

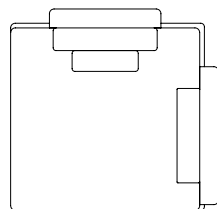

Configurações com 1 assento com encosto fino e 1 braço

Módulo 87 - 1ass/enc/fino(80) + 1br(7) + 1alm/enc(65x50) + 1alm/dec(40x40) + 1rol(62x12)
 Módulo 97 - 1ass/enc/fino(90) + 1br(7) + 1alm/enc(65x50) + 1alm/dec(40x40) + 1rol(62x12)
 Módulo 107 - 1ass/enc/fino(100) + 1br(7) + 1alm/enc(65x50) + 1alm/dec(40x40) + 1rol(62x12)
 Módulo 117 - 1ass/enc/fino(110) + 1br(7) + 1alm/enc(65x50) + 1alm/dec(40x40) + 1rol(62x12)

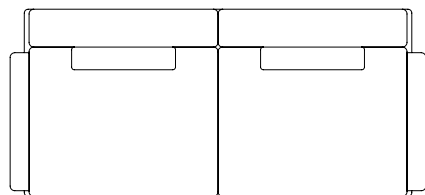

Configurações com 2 assentos e 2 braços

Módulo 174 - 2ass(80) + 2br(7) + 2alm/enc(65x50)
 Módulo 194 - 2ass(90) + 2br(7) + 2alm/enc(65x50)
 Módulo 214 - 2ass(100) + 2br(7) + 2alm/enc(65x50)
 Módulo 234 - 2ass(110) + 2br(7) + 2alm/enc(65x50)



Configurações de Puff

Puff 80 - 1puff(80x75)
 Puff 90 - 1puff(90x75)
 Puff 100 - 1puff(100x75)
 Puff 110 - 1puff(110x75)

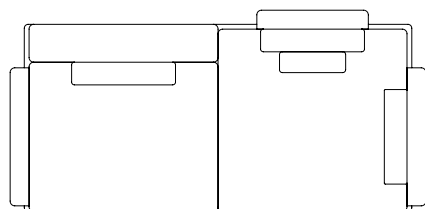

Configurações com 1 assento, 1 assento com encosto fino e 2 braços

Módulo 174 - 1ass(80) + 1ass/enc/fino(80) + 2br(7) + 2alm/enc(65x50) + 1alm/dec(40x40) + 1rol(62x12)
 Módulo 194 - 1ass(90) + 1ass/enc/fino(90) + 2br(7) + 2alm/enc(65x50) + 1alm/dec(40x40) + 1rol(62x12)
 Módulo 214 - 1ass(100) + 1ass/enc/fino(100) + 2br(7) + 2alm/enc(65x50) + 1alm/dec(40x40) + 1rol(62x12)
 Módulo 234 - 1ass(110) + 1ass/enc/fino(110) + 2br(7) + 2alm/enc(65x50) + 1alm/dec(40x40) + 1rol(62x12)

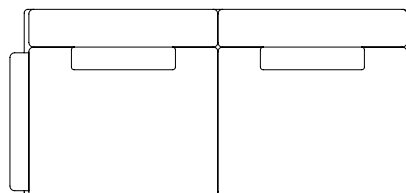

Configurações com 2 assentos e 1 braço

Módulo 167 - 2ass(80) + 1br(7) + 2alm/enc(65x50)
 Módulo 187 - 2ass(90) + 1br(7) + 2alm/enc(65x50)
 Módulo 207 - 2ass(100) + 1br(7) + 2alm/enc(65x50)
 Módulo 227 - 2ass(110) + 1br(7) + 2alm/enc(65x50)



Configurações de Almofada

Alm/enc(65x50)
 Alm/dec(40x40)



Configuração de Rolinho

Rol(62x12)

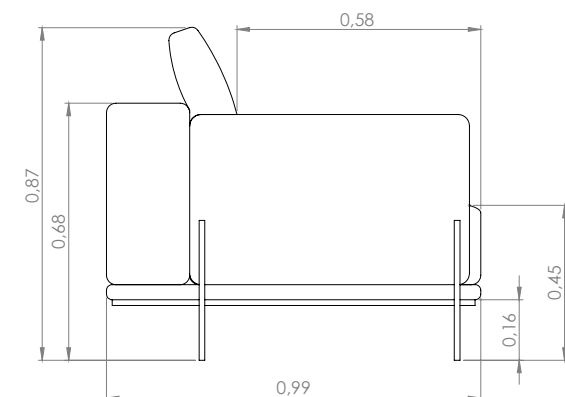

PARA -
CATU -



UNAÍ

Design MAURICIO BOMFIM



ASSISTA O
CONCEITO
DESTE
PRODUTO

DESCRIÇÃO DO PRODUTO

ASSENTO: FIXO - PERCINTA + D33 + HR + D26 ULTRACEL + FIBRA.

ALMOFADA DE ENCOSTO: SOLTA - PENA DE GANSO.

ENCOSTO: FIXO - D20 SOFT + FIBRA.

PÉ: PINTURA ELETROSTÁTICA - CHUMBO, MARROM OU BLACK.

OPCIONAIS: CARREGADOR USB NO BRAÇO (CABO DE ALIMENTAÇÃO PARA TOMADA PADRÃO DO BRASIL OU EUA).

OBSERVAÇÃO: AS OPÇÕES BIPARTIDAS DEVEM SER COMPOSTAS POR UM CONJUNTO DE DOIS MÓDULOS.

DESCRIPTION OF PRODUCT

SEAT: FIXED - ELASTIC BELT + D33 + HR + D26 ULTRACEL + FIBER.

BACKREST CUSHION: LOOSE - GOOSE FEATHER.

BACKREST: FIXED - D20 SOFT + FIBER.

FOOT: ELECTROSTATIC PAINTING - LEAD, BROWN OR BLACK.

OPTIONAL: USB CHARGER ON THE ARMREST (POWER CORD TO STANDARD BRAZIL OR US OUTLET).

NOTE: THE SPLIT OPTIONS MUST BE COMPOSED OF A SET OF TWO MODULES.

DESCRIPCIÓN DEL PRODUCTO

ASIENTO: FIJO - CINTURÓN ELÁSTICO + D33 + HR + D26 ULTRACEL + FIBRA.

ALMOHADA DE RESPALDO: SUELTO - PLUMA DE OCA.

RESPALDO: FIJO - D20 SUAVE + FIBRA.

PIE: PINTURA ELECTROSTÁTICA - PLOMO, MARRÓN O NEGRO.

OPCIONAL: CARGADOR USB EN EL BRAZO (CABLE DE ALIMENTACIÓN A ENCHUFE ESTÁNDAR EN BRASIL O EE. UU.).

NOTA: LAS OPCIONES BIPARTITAS DEBEN ESTAR COMPUESTAS POR UN CONJUNTO DE DOS MÓDULOS.

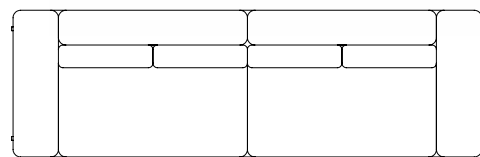

Configurações com 2 assentos, 2 braços e 4 almofadas de encosto

Módulo 276 - 2ass(115) + 2br(23) + 4alm/enc(65x50)

Módulo 296 - 2ass(125) + 2br(23) + 4alm/enc(65x50)

Módulo 290 - 2ass(115) + 2br(30) + 4alm/enc(65x50)

Módulo 310 - 2ass(125) + 2br(30) + 4alm/enc(65x50)

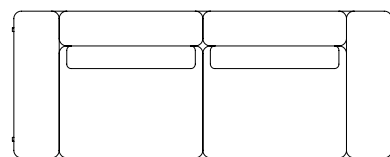

Configurações com 2 assentos, 2 braços e 2 almofadas de encosto

Módulo 236 - 2ass(95) + 2br(23) + 2alm/enc(85x50)

Módulo 256 - 2ass(105) + 2br(23) + 2alm/enc(85x50)

Módulo 250 - 2ass(95) + 2br(30) + 2alm/enc(85x50)

Módulo 270 - 2ass(105) + 2br(30) + 2alm/enc(85x50)

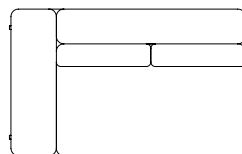

Configurações com 1 assento, 1 braço e 2 almofadas de encosto

Módulo 138 - 1ass(115) + 1br(23) + 2alm/enc(65x50)

Módulo 148 - 1ass(125) + 1br(23) + 2alm/enc(65x50)

Módulo 145 - 1ass(115) + 1br(30) + 2alm/enc(65x50)

Módulo 155 - 1ass(125) + 1br(30) + 2alm/enc(65x50)

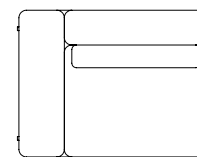

Configurações com 1 assento, 1 braço e 1 almofada de encosto

Módulo 118 - 1ass(95) + 1br(23) + 1alm/enc(85x50)

Módulo 128 - 1ass(105) + 1br(23) + 1alm/enc(85x50)

Módulo 125 - 1ass(95) + 1br(30) + 1alm/enc(85x50)

Módulo 135 - 1ass(105) + 1br(30) + 1alm/enc(85x50)

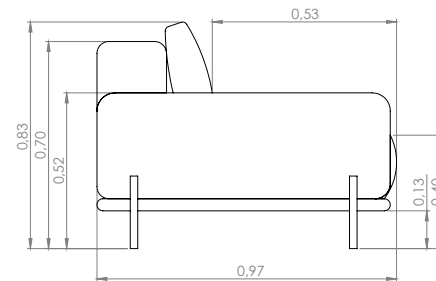

Configurações de Almofada

Alm/enc(65x50)

Alm/enc(85x50)



CONDADO

Design MAURICIO BOMFIM



ASSISTA O
CONCEITO
DESTE
PRODUTO

DESCRIÇÃO DO PRODUTO

ASSENTO: RETRÁTIL - PERCINTA + HR + D33 + D26 ULTRACEL + FIBRA.

ENCOSTO: RECLINÁVEL - HR + D26 ULTRACEL + FIBRA.

ALMOFADA DE ENCOSTO: SOLTA - FIBRA SILICONADA + FIBRA.

PÉ: IMBUÍDA.

OPCIONAIS: CARREGADOR USB NO BRAÇO(33) (CABO DE ALIMENTAÇÃO PARA TOMADA PADRÃO DO BRASIL OU EUA). ASSENTO/ENCOSTO ELÉTRICO OU MANUAL. LIMITE MÁXIMO DE 1,30M PARA O ASSENTO EM MEDIDAS ESPECIAIS.

DESCRIPTION OF PRODUCT

SEAT: RETRACTILE - ELASTIC BELT + HR + D33 + D26 ULTRACEL + FIBER.

BACKREST: RECLINING - HR + D26 ULTRACEL + FIBER.

BACKREST CUSHION: LOOSE - SILICONIZED FIBER + FIBER.

FOOT: IMBUÍDA.

OPTIONAL: USB CHARGER IN THE ARMREST (33) (POWER CORD TO STANDARD BRAZIL OR US OUTLET). ELECTRIC OR MANUAL SEAT/BACKREST. MAXIMUM LIMIT OF 1.30M FOR THE SEAT IN SPECIAL MEASURES.

DESCRIPCIÓN DEL PRODUCTO

ASIENTO: RETRÁCTIL - CINTURÓN ELÁSTICO + HR + D33 + D26 ULTRACEL + FIBRA.

RESPALDO: RECLINABLE - HR + D26 ULTRACEL + FIBRA.

COJÍN DEL RESPALDO: SUELTO - FIBRA SILICONADA + FIBRA.

PIE: IMBUÍDA.

OPCIONAL: CARGADOR USB EN EL BRAZO (33) (CABLE DE ALIMENTACIÓN A ENCHUFE ESTÁNDAR EN BRASIL O EE. UU.). ASIENTO/RESPALDO ELÉCTRICO O MANUAL. LÍMITE MÁXIMO DE 1,30 M PARA EL ASIENTO EN MEDIDAS ESPECIALES.

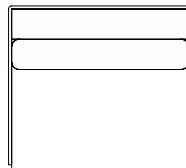

Configurações com 1 assento e 1 braço de 3

Módulo 90 - 1ass(87) + 1br(3) + 1alm/enc(87x48)
Módulo 100 - 1ass(97) + 1br(3) + 1alm/enc(97x48)
Módulo 110 - 1ass(107) + 1br(3) + 1alm/enc(107x48)
Módulo 120 - 1ass(117) + 1br(3) + 1alm/enc(117x48)

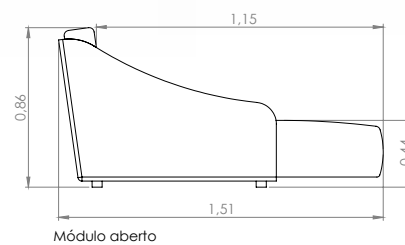

Módulo aberto

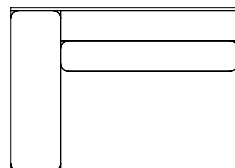

Configurações com 1 assento e 1 braço de 33

Módulo 120 - 1ass(87) + 1br(33) + 1alm/enc(87x48)
Módulo 130 - 1ass(97) + 1br(33) + 1alm/enc(97x48)
Módulo 140 - 1ass(107) + 1br(33) + 1alm/enc(107x48)
Módulo 150 - 1ass(117) + 1br(33) + 1alm/enc(117x48)

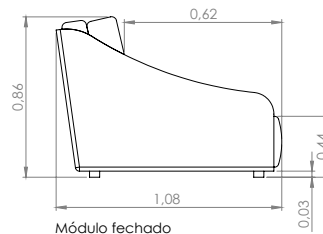

Módulo fechado

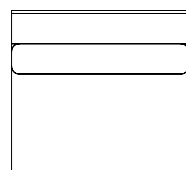

Configurações com 1 assento e sem braço

Módulo 87 - 1ass(87) + 1alm/enc(87x48)
Módulo 97 - 1ass(97) + 1alm/enc(97x48)
Módulo 107 - 1ass(107) + 1alm/enc(107x48)
Módulo 117 - 1ass(117) + 1alm/enc(117x48)



BORÁ

Design MAURICIO BOMFIM



ASSISTA O
CONCEITO
DESTE
PRODUTO

DESCRIÇÃO DO PRODUTO

ASSENTO: FIXO - PERCINTA + HR + D26 ULTRACEL + FIBRA.

ENCOSTO: FIXO - D20 SOFT + FIBRA.

ALMOFADA DE ENCOSTO: SOLTA - PENA DE GANSO.

ALMOFADA DECORATIVA: SOLTA - PENA DE GANSO.

PÉ: PINTURA ELETROSTÁTICA - CHUMBO, MARROM OU BLACK.

OPCIONAIS: CARREGADOR USB NO BRAÇO(30) (CABO DE ALIMENTAÇÃO PARA TOMADA PADRÃO DO BRASIL OU EUA).

OBSERVAÇÃO: NOS MÓDULOS BIPARTIDOS QUE FORMAM CONJUNTO, ACOMPANHA UMA ALMOFADA DE ENCOSTO(65X50), ALÉM DAS DESCRITAS NAS CONFIGURAÇÕES. AS OPÇÕES BIPARTIDAS DEVEM SER COMPOSTAS POR UM CONJUNTO DE DOIS MÓDULOS.

DESCRIPTION OF PRODUCT

SEAT: FIXED – ELASTIC BELT + HR + D26 ULTRACEL + FIBER.

BACKREST: FIXED - D20 SOFT + FIBER.

BACKREST CUSHION: LOOSE - GOOSE FEATHER.

DECORATIVE CUSHION: LOOSE - GOOSE FEATHER.

FOOT: ELECTROSTATIC PAINTING – LEAD, BROWN OR BLACK.

OPTIONAL: USB CHARGER IN THE ARMREST (30) (POWER CORD TO STANDARD BRAZIL OR US OUTLET).

NOTE: IN THE BIPARTITE MODULES FORMING A SET, A BACKREST CUSHION (65X50) IS INCLUDED, IN ADDITION TO THOSE DESCRIBED IN THE CONFIGURATIONS.

THE SPLIT OPTIONS MUST BE COMPOSED OF A SET OF TWO MODULES.

DESCRIPCIÓN DEL PRODUCTO

ASIENTO: FIJO – CINTURÓN ELÁSTICO + HR + D26 ULTRACEL + FIBRA.

RESPALDO: FIJO - D20 SUAVE + FIBRA.

ALMOHADA DE RESPALDO: SUELTO - PLUMA DE OCA.

ALMOHADA DECORATIVA: SUELTA - PLUMA DE OCA.

PIE: PINTURA ELECTROSTÁTICA – PLOMO, MARRÓN O NEGRO.

OPCIONAL: CARGADOR USB EN EL BRAZO (30) (CABLE DE ALIMENTACIÓN A ENCHUFE ESTÁNDAR EN BRASIL O EE. UU.).

OBSERVACIONES: LOS MÓDULOS BIFURCADOS QUE FORMAN UN CONJUNTO SE ACOMPAÑAN DE UNA ALMOHADA DE RESPALDO (65X50), ADEMÁS DE LOS DESCRITOS EN LAS CONFIGURACIONES.

LAS OPCIONES BIPARTITAS DEBEN ESTAR COMPUESTAS POR UN CONJUNTO DE DOS MÓDULOS.

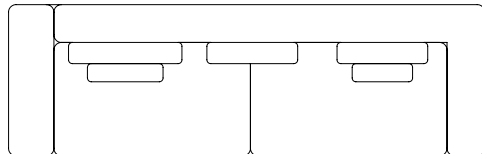

Configurações com 2 assentos, 1 braço e 1 braço/encosto

Módulo 255 - 2ass(100) + 1br(30) + 1br/enc(25) + 2alm/enc(65x50) + 1alm/enc(85x50) + 1alm/enc(65x45) + 1alm/dec(40x40)

Módulo 275 - 2ass(110) + 1br(30) + 1br/enc(25) + 2alm/enc(65x50) + 1alm/enc(85x50) + 1alm/enc(65x45) + 1alm/dec(40x40)

Módulo 295 - 2ass(120) + 1br(30) + 1br/enc(25) + 2alm/enc(65x50) + 1alm/enc(85x50) + 1alm/enc(65x45) + 1alm/dec(40x40)

Módulo 315 - 2ass(130) + 1br(30) + 1br/enc(25) + 2alm/enc(65x50) + 1alm/enc(85x50) + 1alm/enc(65x45) + 1alm/dec(40x40)

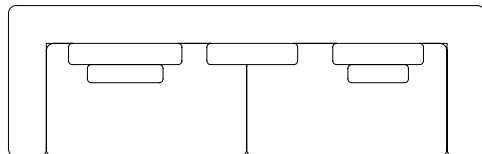

Configurações com 2 assentos e 2 braços/encostos

Módulo 250 - 2ass(100) + 2br/enc(25) + 2alm/enc(65x50) + 1alm/enc(85x50) + 1alm/enc(65x45) + 1alm/dec(40x40)

Módulo 270 - 2ass(110) + 2br/enc(25) + 2alm/enc(65x50) + 1alm/enc(85x50) + 1alm/enc(65x45) + 1alm/dec(40x40)

Módulo 290 - 2ass(120) + 2br/enc(25) + 2alm/enc(65x50) + 1alm/enc(85x50) + 1alm/enc(65x45) + 1alm/dec(40x40)

Módulo 310 - 2ass(130) + 2br/enc(25) + 2alm/enc(65x50) + 1alm/enc(85x50) + 1alm/enc(65x45) + 1alm/dec(40x40)

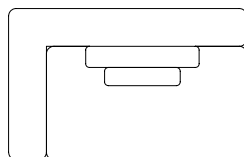

Configurações com 1 assento e 1 braço/encosto

Módulo 125 - 1ass(100) + 1br/enc(25) + 1alm/enc(65x50) + 1alm/dec(40x40)

Módulo 135 - 1ass(110) + 1br/enc(25) + 1alm/enc(65x50) + 1alm/dec(40x40)

Módulo 145 - 1ass(120) + 1br/enc(25) + 1alm/enc(65x50) + 1alm/dec(40x40)

Módulo 155 - 1ass(130) + 1br/enc(25) + 1alm/enc(65x50) + 1alm/dec(40x40)

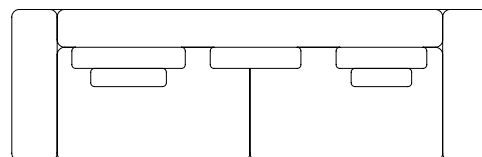

Configurações com 2 assentos e 2 braços

Módulo 260 - 2ass(100) + 2br(30) + 2alm/enc(65x50) + 1alm/enc(85x50) + 1alm/enc(65x45) + 1alm/dec(40x40)

Módulo 280 - 2ass(110) + 2br(30) + 2alm/enc(65x50) + 1alm/enc(85x50) + 1alm/enc(65x45) + 1alm/dec(40x40)

Módulo 300 - 2ass(120) + 2br(30) + 2alm/enc(65x50) + 1alm/enc(85x50) + 1alm/enc(65x45) + 1alm/dec(40x40)

Módulo 320 - 2ass(130) + 2br(30) + 2alm/enc(65x50) + 1alm/enc(85x50) + 1alm/enc(65x45) + 1alm/dec(40x40)

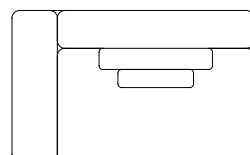

Configurações com 1 assento e 1 braço

Módulo 130 - 1ass(100) + 1br(30) + 1alm/enc(85x50) + 1alm/enc(65x45)

Módulo 140 - 1ass(110) + 1br(30) + 1alm/enc(85x50) + 1alm/enc(65x45)

Módulo 150 - 1ass(120) + 1br(30) + 1alm/enc(85x50) + 1alm/enc(65x45)

Módulo 160 - 1ass(130) + 1br(30) + 1alm/enc(85x50) + 1alm/enc(65x45)

Configurações de Almofadas

Alm/dec(40x40)

Alm/enc(65x45)

Alm/enc(65x50)

Alm/enc(85x50)

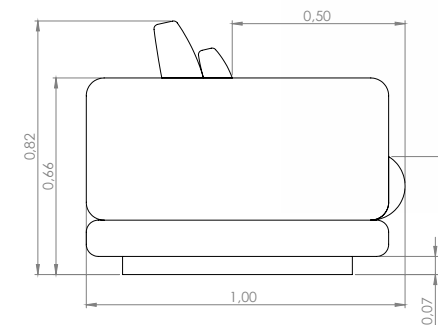

COPAÍBA

Design MAURICIO BOMFIM



ASSISTA O
CONCEITO
DESTE
PRODUTO

DESCRIÇÃO DO PRODUTO

ASSENTO: FIXO - PERCINTA + HR + D33 + D26 ULTRACEL + FIBRA.

ENCOSTO: FIXO - HR + D33 + FIBRA.

ALMOFADA DE ENCOSTO: SOLTA - ALGODÃO.

PÉ: IMBUÍIA.

MESA: PARANA SOFT, DARK OU MOLDE.

DETALHE CHAPA DE AÇO: PINTURA ELETROSTÁTICA - CHUMBO, MARROM OU BLACK.

OBSERVAÇÕES: NA OPÇÃO DE ACABAMENTO DA MESA TEMOS A OPÇÃO "MOLDE", NO QUAL SERÁ ENVIADO UM MOLDE DO PORCELANATO PARA QUE O CLIENTE CONFECCIONE A MESA NO MATERIAL QUE DESEJAR.



DESCRIPTION OF PRODUCT

SEAT: FIXED - ELASTIC BELT + HR + D33 + D26 ULTRACEL + FIBER.

BACKREST: FIXED - HR + D33 + FIBER.

BACKREST CUSHION: LOOSE - COTTON.

FOOT: IMBUÍIA.

TABLE: PARANA SOFT, DARK OR MOLD.

STEEL SHEET DETAIL: ELECTROSTATIC PAINTING - LEAD, BROWN OR BLACK.

NOTE: IN THE TABLE FINISHING OPTION WE HAVE THE "MOLD" OPTION, IN WHICH A PORCELAIN TILE MOLD WILL BE SENT TO THE CUSTOMER TO MAKE THE TABLE IN THE MATERIAL HE/SHE DESIRES.



DESCRIPCIÓN DEL PRODUCTO

ASIENTO: FIJO - CINTURÓN ELÁSTICO + HR + D33 + D26 ULTRACEL + FIBRA.

RESPALDO: FIJO - HR + D33 + FIBRA.

ALMOHADA DE RESPALDO: SUELTO - ALGODÓN.

PIEA: IMBUÍIA.

TABLA: PARANÁ BLANDO, OSCURO O MOLDE.

DETALLE DE LA CHAPA DE ACERO: PINTURA ELECTROSTÁTICA - PLOMO, MARRÓN O NEGRA.

OBSERVACIONES: EN LA OPCIÓN DE ACABADO DE LA MESA TENEMOS LA OPCIÓN "MOLDE", EN LA QUE SE ENVIARÁ AL CLIENTE UN MOLDE DE GRES PORCELÁNICO PARA REALIZAR LA MESA EN EL MATERIAL QUE DESEE.

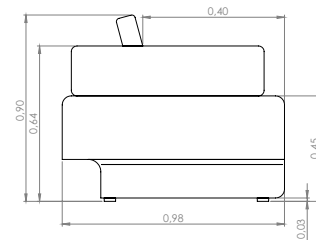

COPAIBA



Configuração de Almofada
Alm/enc(50x50)

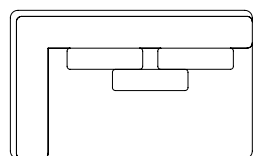

Configurações com 1 assento e 1 braço

Módulo 100 - 1ass(74) + 1br(26) + 3alm/enc(50x50)
Módulo 120 - 1ass(94) + 1br(26) + 3alm/enc(50x50)
Módulo 140 - 1ass(114) + 1br(26) + 3alm/enc(50x50)
Módulo 160 - 1ass(134) + 1br(26) + 3alm/enc(50x50)

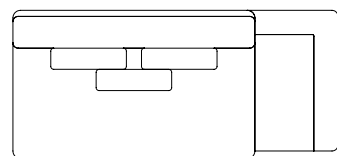

Configurações com 1 assento e 1 mesa

Módulo 155 - 1ass(100) + 1mesa(55) + 3alm/enc(50x50)
Módulo 175 - 1ass(120) + 1mesa(55) + 3alm/enc(50x50)
Módulo 195 - 1ass(140) + 1mesa(55) + 3alm/enc(50x50)
Módulo 215 - 1ass(160) + 1mesa(55) + 3alm/enc(50x50)

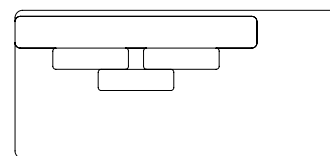

Configurações com 1 assento e 1 puff

Módulo 155 - 1ass(100) + 1puff(55) + 3alm/enc(50x50)
Módulo 175 - 1ass(120) + 1puff(55) + 3alm/enc(50x50)
Módulo 195 - 1ass(140) + 1puff(55) + 3alm/enc(50x50)
Módulo 215 - 1ass(160) + 1puff(55) + 3alm/enc(50x50)

TUCUM

Design MAURICIO BOMFIM



ASSISTA O
CONCEITO
DESTE
PRODUTO

DESCRIÇÃO DO PRODUTO

ASSENTO: FIXO - PERCINTA + HR + D33 + D26 ULTRACEL + FIBRA.
ENCOSTO/BRAÇO FIXO: FIXO - D20 SOFT.
ALMOFADA DE ENCOSTO: SOLTA - D33 + D26 ULTRACEL + FIBRA.
ALMOFADA DE RIM: SOLTA - ALGODÃO + D26 ULTRACEL + FIBRA.
ENCOSTO SOLTO: SOLTO - D33 + FIBRA.
BRAÇO SOLTO: SOLTO - D33 + FIBRA.
PÉ: PINTURA ELETROSTÁTICA - CHUMBO, MARROM OU BLACK.
OBSERVAÇÕES: NAS CONFIGURAÇÕES COM LARGURA DE ASSENTO ACIMA DE 1,20M REVESTIDAS EM COURO, HAVERÁ UMA EMENDA NO ASSENTO.

TUCUM

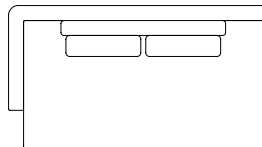

Configurações com 1 assento e 1 braço

Módulo 110 - 1ass(100) + 1br(10) + 2alm/enc(50x50) + 1alm/rim(100x32)
 Módulo 130 - 1ass(120) + 1br(10) + 2alm/enc(50x50) + 1alm/rim(100x32)
 Módulo 150 - 1ass(140) + 1br(10) + 2alm/enc(50x50) + 1alm/rim(110x32)
 Módulo 170 - 1ass(160) + 1br(10) + 2alm/enc(50x50) + 1alm/rim(110x32)

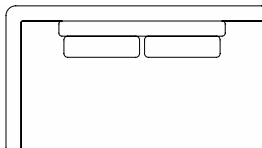

Configurações com 1 assento e 1 encosto invertido

Módulo 110 - 1ass(100) + 1enc/inv(10) + 2alm/enc(50x50) + 1alm/rim(100x32)
 Módulo 130 - 1ass(120) + 1enc/inv(10) + 2alm/enc(50x50) + 1alm/rim(100x32)
 Módulo 150 - 1ass(140) + 1enc/inv(10) + 2alm/enc(50x50) + 1alm/rim(110x32)
 Módulo 170 - 1ass(160) + 1enc/inv(10) + 2alm/enc(50x50) + 1alm/rim(110x32)

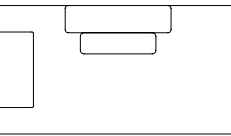

Configurações de Puff

Puff 100 - 1puff(100) + 1enc/solto(70) + 1br/solto(24) + 1alm/enc(50x50)
 Puff 120 - 1puff(120) + 1enc/solto(70) + 1br/solto(24) + 1alm/enc(50x50)
 Puff 140 - 1puff(140) + 1enc/solto(70) + 1br/solto(24) + 1alm/enc(50x50)
 Puff 160 - 1puff(160) + 1enc/solto(70) + 1br/solto(24) + 1alm/enc(50x50)



Configuração de Almofada
 Alm/enc(50x50)

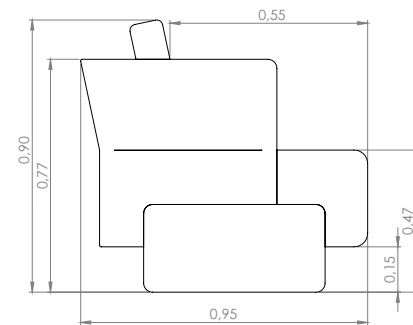

DESCRIPCIÓN DEL PRODUCTO

ASIENTO: FIJO - CINTURÓN ELÁSTICO + HR + D33 + D26 ULTRACEL + FIBRA.
RESPALDO/APOYABRAZOS FIJOS: FIJO - D20 SUAVE.
ALMOHADA DE RESPALDO: SUELTO - D33 + D26 ULTRACEL + FIBRA.
ALMOHADA DECORATIVA: SUELTO - ALGODÓN + D26 ULTRACEL + FIBRA.
RESPALDO SUELTO: SUELTO - D33 + FIBRA.
BRAZO SUELTO: SUELTO - D33 + FIBRA.
PIE: PINTURA ELECTROSTÁTICA - PLOMO, MARRÓN O NEGRO.
OBSERVACIONES: EN LAS CONFIGURACIONES CON UNA ANCHURA DE ASIENTO SUPERIOR A 1,20 M RECUBIERTAS DE PIEL, HABRÁ UNA COSTURA EN EL ASIENTO.

AROEIRA

Design MAURICIO BOMFIM



ASSISTA O
CONCEITO
DESTE
PRODUTO

DESCRIÇÃO DO PRODUTO

ASSENTO: FIXO - PERCINTA + HR + D33 + D26 ULTRACEL + FIBRA.

ENCOSTO: FIXO - HR + D20 SOFT + FIBRA.

ALMOFADA DE ENCOSTO: SOLTA - ALGODÃO + D26 ULTRACEL + FIBRA.

ALMOFADA DE RIM: SOLTA - ALGODÃO + D26 ULTRACEL + FIBRA.

ROLINHO: SOLTO - D33 + FIBRA.

PÉS: LÂMINA NATURAL - CARVALHO NATURAL, CARVALHO EBANIZADO, CARVALHO LINEN OU NOGUEIRA. PINTURA ELETROSTÁTICA - CHUMBO, MARROM OU BLACK.

MESA: LÂMINA NATURAL - CARVALHO NATURAL, CARVALHO EBANIZADO, CARVALHO LINEN OU NOGUEIRA. PINTURA ELETROSTÁTICA - CHUMBO, MARROM OU BLACK.

OPCIONAIS: CARREGADOR USB NO BRAÇO (CABO DE ALIMENTAÇÃO PARA TOMADA PADRÃO DO BRASIL OU EUA).

OBSERVAÇÕES: AS BORDAS DOS PÉS E A PARTE INTERNA DA MESA SÃO PINTADAS. O PRODUTO DEVERÁ SER COMPOSTO POR UM CONJUNTO DE DOIS MÓDULOS.

DESCRIPTION OF PRODUCT

SEAT: FIXED - ELASTIC BELT + HR + D33 + D26 ULTRACEL + FIBER.

BACKREST: FIXED - D20 SOFT + FIBER.

BACKREST CUSHION: LOOSE - COTTON + D26 ULTRACEL + FIBER.

LUMBAR CUSHION: LOOSE - COTTON + D26 ULTRACEL + FIBER.

ROLL CUSHION: LOOSE - D33 + FIBER.

FOOT: NATURAL VENEER - NATURAL OAK, EBANIZED OAK, OAK LINEN OR WALNUT. ELECTROSTATIC PAINT - LEAD, BROWN OR BLACK.

TABLE: NATURAL VENEER - NATURAL OAK, EBONY OAK, LINEN OAK OR WALNUT. ELECTROSTATIC PAINT - LEAD, BROWN OR BLACK.

OPTIONAL: USB CHARGER IN THE ARMREST (POWER CORD TO STANDARD BRAZIL OR US OUTLET).

NOTE: THE EDGES OF THE FEET AND THE INTERNAL PART OF THE TABLE ARE PAINTED. THE PRODUCT MUST BE COMPOSED OF A SET OF TWO MODULES.

DESCRIPCIÓN DEL PRODUCTO

ASIENTO: FIJO - CINTURÓN ELÁSTICO + HR + D33 + D26 ULTRACEL + FIBRA.

RESPALDO: FIJO - HR + D20 SUAVE + FIBRA.

ALMOHADA DE RESPALDO: SUELTO - ALGODÓN + D26 ULTRACEL + FIBRA.

ALMOHADA ESPALDA BAJA: SUELTO - ALGODÓN + D26 ULTRACEL + FIBRA.

ALMOHADA DE RODILLO: SUELTO - D33 + FIBRA.

PIES: CHAPA NATURAL - ROBLE NATURAL, ROBLE EBANIZADO, ROBLE LINO O NOGAL. PINTURA ELETROSTÁTICA - PLOMO, MARRÓN O NEGRO.

MESA: CHAPA NATURAL - ROBLE NATURAL, ROBLE ÉBANO, ROBLE LINO O NOGAL. PINTURA ELETROSTÁTICA - PLOMO, MARRÓN O NEGRO.

OPCIONAL: CARGADOR USB EN EL BRAZO (CABLE DE ALIMENTACIÓN A ENCHUFE ESTÁNDAR EN BRASIL O EE. UU.).

OBSERVACIONES: LOS BORDES DE LOS PIES Y LA PARTE INTERNA DE LA MESA ESTÁN PINTADOS. EL PRODUCTO DEBE CONSISTIR EN UN CONJUNTO DE DOS MÓDULOS.

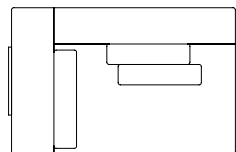

Configurações com 1 assento e 1 braço

Módulo 108 - 1ass(80) + 1br(28) + 2alm/enc(50x50) + 1rol(64x13)
 Módulo 118 - 1ass(90) + 1br(28) + 2alm/enc(50x50) + 1rol(64x13)
 Módulo 128 - 1ass(100) + 1br(28) + 2alm/enc(50x50) + 1rol(64x13)
 Módulo 138 - 1ass(110) + 1br(28) + 2alm/enc(50x50) + 1rol(64x13)
 Módulo 148 - 1ass(120) + 1br(28) + 2alm/enc(50x50) + 1rol(64x13)

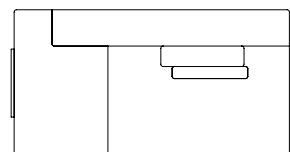

Configurações com 1 assento e 1 mesa

Módulo 142 - 1ass(80) + 1mesa(62) + 1alm/enc(50x50) + 1alm/rim(50x30)
 Módulo 152 - 1ass(90) + 1mesa(62) + 1alm/enc(50x50) + 1alm/rim(50x30)
 Módulo 162 - 1ass(100) + 1mesa(62) + 1alm/enc(50x50) + 1alm/rim(50x30)
 Módulo 172 - 1ass(110) + 1mesa(62) + 1alm/enc(50x50) + 1alm/rim(50x30)
 Módulo 182 - 1ass(120) + 1mesa(62) + 1alm/enc(50x50) + 1alm/rim(50x30)



Configurações de Almofadas

Alm/enc(50x50)
 Alm/rim(50x30)

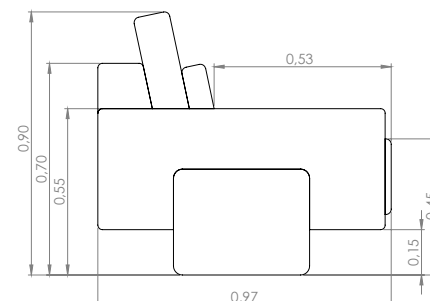

AROEIRA

ABIU

Design MAURICIO BOMFIM



ASSISTA O
CONCEITO
DESTE
PRODUTO

DESCRIÇÃO DO PRODUTO

ASSENTO: SOLTO - HR + MOLA POCKET + D26 ULTRACEL + FIBRA.

ENCOSTO: FIXO - HR + D20 SOFT + FIBRA.

ALMOFADA DE ENCOSTO: SOLTA - PENA DE GANSO.

PÉS: PINTURA ELETROSTÁTICA - CHUMBO, MARROM OU BLACK.

OBSERVAÇÕES: AS CONFIGURAÇÕES COM 3 ASSENTOS SÃO BIPARTIDAS. O PRODUTO DEVERÁ SER COMPOSTO POR UM CONJUNTO DE DOIS MÓDULOS (EXCETO QUANDO POLTRONA). O PÉ CENTRAL FAZ A UNIÃO DOS MÓDULOS.

DESCRIPTION OF PRODUCT

SEAT: LOOSE - HR + POCKET SPRING + D26 ULTRACEL + FIBER.

BACKREST: FIXED - HR + D20 SOFT + FIBER.

BACKREST CUSHION: LOOSE - GOOSE FEATHER.

FOOT: ELECTROSTATIC PAINTING - LEAD, BROWN OR BLACK.

NOTE: THE CONFIGURATIONS WITH 3 SEATS ARE SPLIT. THE PRODUCT MUST BE COMPOSED OF A SET OF TWO MODULES (EXCEPT WHEN AN ARMCHAIR). THE CENTRAL FOOT CONNECTS THE MODULES.

DESCRIPCIÓN DEL PRODUCTO

ASIENTO: SUELTO - HR + RESORTE EMBOLSADO + D26 ULTRACEL + FIBRA.

RESPALDO: FIJO - HR + D20 SUAVE + FIBRA.

ALMOHADA DE RESPALDO: SUELTO - PLUMA DE OCA

PIES: PINTURA ELECTROSTÁTICA - PLOMO, MARRÓN O NEGRO.

OBSERVACIONES: LAS CONFIGURACIONES CON 3 ASIENTOS SON BIPARTITAS. EL PRODUCTO DEBE ESTAR COMPUESTO POR UN CONJUNTO DE DOS MÓDULOS (EXCEPTO LOS SILLONES). EL PIE CENTRAL CONECTA LOS MÓDULOS.

ABIU

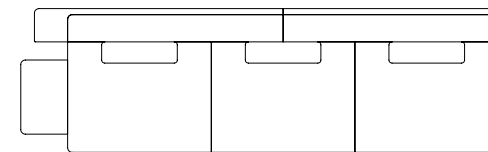

Configurações com 3 assentos, 1 braço e 1 mesa

Módulo 230 - 3ass(65) + 1br(3) + 1mesa(32) + 3alm/enc(60x50)
 Módulo 260 - 3ass(75) + 1br(3) + 1mesa(32) + 3alm/enc(60x50)
 Módulo 290 - 3ass(85) + 1br(3) + 1mesa(32) + 3alm/enc(60x50)
 Módulo 320 - 3ass(95) + 1br(3) + 1mesa(32) + 3alm/enc(60x50)

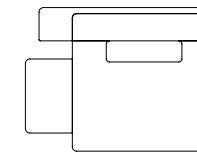

Configurações com 1 assento e 1 mesa

Módulo 97 - 1ass(65) + 1mesa(32) + 1alm/enc(60x50)
 Módulo 107 - 1ass(75) + 1mesa(32) + 1alm/enc(60x50)
 Módulo 117 - 1ass(85) + 1mesa(32) + 1alm/enc(60x50)
 Módulo 127 - 1ass(95) + 1mesa(32) + 1alm/enc(60x50)

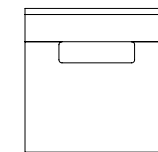

Configurações com 1 assento e 1 braço

Módulo 68 - 1ass(65) + 1br(3) + 1alm/enc(60x50)
 Módulo 78 - 1ass(75) + 1br(3) + 1alm/enc(60x50)
 Módulo 88 - 1ass(85) + 1br(3) + 1alm/enc(60x50)
 Módulo 98 - 1ass(95) + 1br(3) + 1alm/enc(60x50)

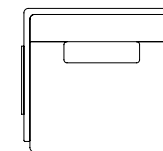

Configuração de Poltrona

Poltrona 101 - 1ass(95) + 2br(3) + 1alm/enc(60x50)



Configuração de almofada de encosto

Alm/enc(60x50)

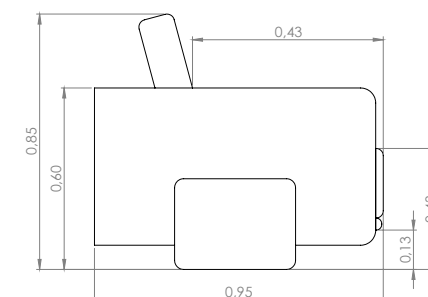

STEEL

Design MAURICIO BOMFIM



ASSISTA O
CONCEITO
DESTE
PRODUTO

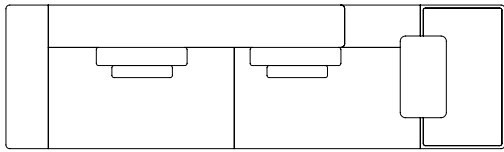

Configurações com 2 assentos, 1 braço e 2 mesas

Módulo 250 - 2ass(83) + 1br(28) + 1mesa(30,5) + 1mesa(39) + 2alm/enc(65x60) + 2alm/dec(40x40)
 Módulo 270 - 2ass(93) + 1br(28) + 1mesa(30,5) + 1mesa(39) + 2alm/enc(65x60) + 2alm/dec(40x40)
 Módulo 290 - 2ass(103) + 1br(28) + 1mesa(30,5) + 1mesa(39) + 2alm/enc(65x60) + 2alm/dec(40x40)
 Módulo 310 - 2ass(113) + 1br(28) + 1mesa(30,5) + 1mesa(39) + 2alm/enc(65x60) + 2alm/dec(40x40)
 Módulo 330 - 2ass(123) + 1br(28) + 1mesa(30,5) + 1mesa(39) + 2alm/enc(65x60) + 2alm/dec(40x40)

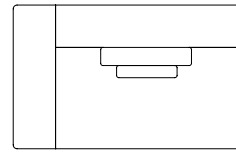

Configurações com 1 assento e 1 braço

Módulo 111 - 1ass(83) + 1br(28) + 1alm/enc(65x60) + 1alm/dec(40x40)
 Módulo 121 - 1ass(93) + 1br(28) + 1alm/enc(65x60) + 1alm/dec(40x40)
 Módulo 131 - 1ass(103) + 1br(28) + 1alm/enc(65x60) + 1alm/dec(40x40)
 Módulo 141 - 1ass(113) + 1br(28) + 1alm/enc(65x60) + 1alm/dec(40x40)
 Módulo 151 - 1ass(123) + 1br(28) + 1alm/enc(65x60) + 1alm/dec(40x40)

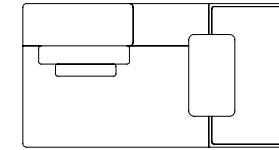

Configurações com 1 assento e 2 mesas

Módulo 139 - 1ass(83) + 1mesa(30,5) + 1mesa(39) + 1alm/enc(65x60) + 1alm/dec(40x40)
 Módulo 149 - 1ass(93) + 1mesa(30,5) + 1mesa(39) + 1alm/enc(65x60) + 1alm/dec(40x40)
 Módulo 159 - 1ass(103) + 1mesa(30,5) + 1mesa(39) + 1alm/enc(65x60) + 1alm/dec(40x40)
 Módulo 169 - 1ass(113) + 1mesa(30,5) + 1mesa(39) + 1alm/enc(65x60) + 1alm/dec(40x40)
 Módulo 179 - 1ass(123) + 1mesa(30,5) + 1mesa(39) + 1alm/enc(65x60) + 1alm/dec(40x40)

STEEL

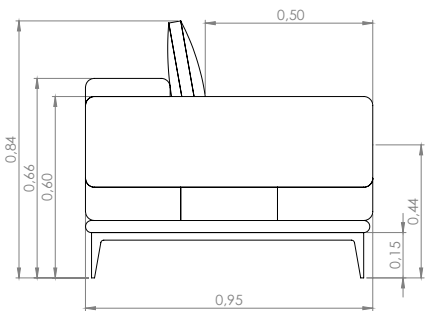

DESCRIÇÃO DO PRODUTO

ASSENTO: FIXO - PERCINTA + HR + D33 + D26 ULTRACEL + FIBRA.
ENCOSTO: FIXO - D33 + D20 SOFT + FIBRA.
ALMOFADA DE ENCOSTO: SOLTA - PENA DE GANSO.
ALMOFADA DECORATIVA: SOLTA - PENA DE GANSO.
BASE: PINTURA ELETROSTÁTICA - CHUMBO, MARROM OU BLACK.
MESA: LÂMINA NATURAL - CARVALHO NATURAL, CARVALHO EBANIZADO, CARVALHO LINEN OU NOGUEIRA.
ESTRUTURA BRAÇO E MESA: PINTURA ELETROSTÁTICA - CHUMBO, MARROM OU BLACK.
OBSERVAÇÕES: A MEDIDA DA MESA SUPERIOR NÃO IMPLICA NA MEDIDA TOTAL DO PRODUTO. A MESA INFERIOR CONTÉM 39CM DE LARGURA, PORÉM, APLICADA AO PRODUTO ELA OCUPA UM ESPAÇO DE 56CM NA CONFIGURAÇÃO FINAL. PRODUTO INDISPONÍVEL EM COURO.

DESCRIPTION OF PRODUCT

SEAT: FIXED - ELASTIC BELT + HR + D33 + D26 ULTRACEL + FIBER.
BACKREST: FIXED - D33 + D20 SOFT + FIBER.
BACKREST CUSHION: LOOSE - GOOSE FEATHER.
DECORATIVE CUSHION: LOOSE - GOOSE FEATHER.
BASE: ELECTROSTATIC PAINTING - LEAD, BROWN OR BLACK.
TABLE: NATURAL VENEER - NATURAL OAK, EBONIZED OAK, OAK LINEN OR WALNUT.
ARM AND TABLE STRUCTURE: ELECTROSTATIC PAINTING - LEAD, BROWN OR BLACK.
NOTE: THE MEASURE OF THE UPPER TABLE DOES NOT IMPLY THE TOTAL MEASURE OF THE PRODUCT. THE LOWER TABLE IS 39CM WIDE, HOWEVER, APPLIED TO THE PRODUCT IT OCCUPIES A SPACE OF 56CM IN THE FINAL CONFIGURATION. PRODUCT UNAVAILABLE IN LEATHER.

DESCRIPCIÓN DEL PRODUCTO

ASIENTO: FIJO - CINTURÓN ELÁSTICO + HR + D33 + D26 ULTRACEL + FIBRA.
RESPALDO: FIJO - D33 + D20 SUAVE + FIBRA.
ALMOHADA DE RESPALDO: SUELTO - PLUMA DE OCA.
ALMOHADA DECORATIVA: SUELTO - PLUMA DE OCA.
BASE: PINTURA ELECTROSTÁTICA - PLOMO, MARRÓN O NEGRO.
MESA: CHAPA NATURAL - ROBLE NATURAL, ROBLE ÉBANO, ROBLE LINO O NOGAL.
ESTRUTURA DEL BRAZO Y MESA: PINTURA ELECTROSTÁTICA - PLOMO, MARRÓN O NEGRO.
OBSERVACIONES: LA MEDIDA DE LA TABLA SUPERIOR NO IMPLICA LA MEDIDA TOTAL DEL PRODUCTO. LA MESA INFERIOR TIENE 39CM DE ANCHO, SIN EMBARGO, APLICADA AL PRODUCTO OCUPA UN ESPACIO DE 56CM EN LA CONFIGURACIÓN FINAL. PRODUCTO NO DISPONIBLE EN PIEL.

FLOAT

Design MAURICIO BOMFIM



FLOAT



OS TAMAÑOS DAS ALMOFADAS DA IMAGEM NÃO CORRESPONDEM ÀS MEDIDAS PADRÕES DO PRODUTO. AS DIMENSÕES REAIS PODEM SER VERIFICADAS NA LISTA DE CONFIGURAÇÕES.

THE SIZES OF THE PILLOWS IN THE IMAGE DO NOT CORRESPOND TO THE STANDARD MEASUREMENTS OF THE PRODUCT. ACTUAL DIMENSIONS CAN BE CHECKED IN THE CONFIGURATION LIST.

LOS TAMAÑOS DE LAS ALMOHADAS DE LA IMAGEN NO SE CORRESPONDEN CON LAS MEDIDAS ESTÁNDAR DEL PRODUCTO. LAS DIMENSIONES REALES SE PUEDEN COMPROBAR EN LA LISTA DE CONFIGURACIÓN

DESCRIÇÃO DO PRODUTO

ASSENTO: FIXO - PERCINTA + HR + D33 + D26 ULTRACEL + FIBRA.

ENCOSTO: FIXO - HR + D20 SOFT + D26 ULTRACEL + FIBRA.

ALMOFADA DE ENCOSTO: SOLTA - ALGODÃO + D26 ULTRACEL + FIBRA.

ALMOFADA DECORATIVA: SOLTA - ALGODÃO + D26 ULTRACEL + FIBRA.

ALMOFADA DE RIM: SOLTA - ALGODÃO + D26 ULTRACEL + FIBRA.

BASE: PINTURA ELETROSTÁTICA - CHUMBO, MARROM OU BLACK.

MESA: LÂMINA NATURAL - CARVALHO NATURAL, CARVALHO EBANIZADO, CARVALHO LINEN OU NOGUEIRA. TINGIMENTO - TINGIMENTO NATURAL, EBANIZADO, LINEN, NOGUEIRA, NOZES OU IMBUIA.

GAVETÃO: LÂMINA NATURAL - CARVALHO NATURAL, CARVALHO EBANIZADO, CARVALHO LINEN OU NOGUEIRA.

TINGIMENTO - TINGIMENTO NATURAL, EBANIZADO, LINEN, NOGUEIRA, NOZES OU IMBUIA.

OPCIONAIS: CARREGADOR USB NO BRAÇO (CABO DE ALIMENTAÇÃO PARA TOMADA PADRÃO DO BRASIL OU EUA).

OBSERVAÇÕES: A MESA CONTÉM 30CM DE LARGURA, PORÉM, APLICADA AO PRODUTO ELA OCUPA UM ESPAÇO DE 20CM NA CONFIGURAÇÃO FINAL.

DESCRIPTION OF PRODUCT

SEAT: FIXED - ELASTIC BELT + HR + D33 + D26 ULTRACEL + FIBER.

BACKREST: FIXED - HR + D20 SOFT + D26 ULTRACEL + FIBER.

BACKREST CUSHION: LOOSE - COTTON + D26 ULTRACEL + FIBER.

DECORATIVE CUSHION: LOOSE - COTTON + D26 ULTRACEL + FIBER.

LUMBAR CUSHION: LOOSE - COTTON + D26 ULTRACEL + FIBER.

BASE: ELECTROSTATIC PAINTING - LEAD, BROWN OR BLACK.

TABLE: NATURAL VENEER - NATURAL OAK, EBANIZED OAK, OAK LINEN OR WALNUT.

DYEING - NATURAL DYED, EBANIZED, LINEN, WALNUT OR IMBUIA.

INVOLVING STRUCTURE: NATURAL VENEER - NATURAL

OAK, EBANIZED OAK, OAK LINEN OR WALNUT.

DYEING - NATURAL DYED, EBANIZED, LINEN, WALNUT, WALNUT, OR IMBUIA.

OPTIONAL: USB CHARGER IN THE ARMREST (POWER CORD TO STANDARD BRAZIL OR US OUTLET).

NOTE: THE TABLE CONTAINS 30CM WIDTH, HOWEVER, APPLIED TO THE PRODUCT IT OCCUPIES A SPACE OF 20CM IN THE FINAL CONFIGURATION.

DESCRIPCIÓN DEL PRODUCTO

ASIENTO: FIJO - CINTURÓN ELÁSTICO + HR + D33 + D26 ULTRACEL + FIBRA.

RESPALDO: FIJO - HR + D20 BLANDO + D26 ULTRACEL + FIBRA.

ALMOHADA DE RESPALDO: SUELTO - ALGODÓN + D26 ULTRACEL + FIBRA.

ALMOHADA DECORATIVA: SUELTA - ALGODÓN + D26 ULTRACEL + FIBRA.

ALMOHADA ESPALDA BAJA: SUELTO - ALGODÓN + D26 ULTRACEL + FIBRA.

BASE: PINTURA ELECTROSTÁTICA - PLOMO, MARRÓN O NEGRO.

MESA: CHAPA NATURAL - ROBLE NATURAL, ROBLE EBANIZADO, ROBLE LINO O NOGAL.

TEÑIDO - TINTE NATURAL, EBANIZADO, LINO, NOGAL O IMBUIA. C17

CAJÓN: CHAPA NATURAL - ROBLE NATURAL,

ROBLE EBANIZADO, ROBLE LINO O NOGAL.

TINTE - TINTE NATURAL, EBANIZADO, LINO, NOGAL, NUEZ O IMBUIA.

OPCIONAL: CARGADOR USB EN EL BRAZO (CABLE DE ALIMENTACIÓN A ENCHUFE ESTÁNDAR EN BRASIL O EE. UU.).

OBSERVACIONES: LA MESA CONTIENE 30CM DE ANCHO, SIN EMBARGO, APLICADA AL PRODUCTO OCUPA UN ESPACIO DE 20CM EN LA CONFIGURACIÓN FINAL.

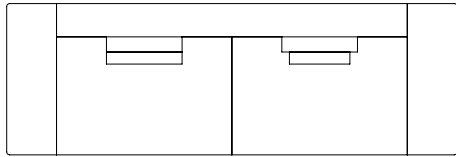

Configurações com 2 assentos e 2 braços

Módulo 208 - 2ass(71) + 2br(33) + 2alm/enc(55x50) + 1alm/dec(40x40) + 1alm/rim(50x30)
 Módulo 238 - 2ass(86) + 2br(33) + 2alm/enc(70x50) + 1alm/dec(40x40) + 1alm/rim(50x30)
 Módulo 268 - 2ass(101) + 2br(33) + 2alm/enc(85x50) + 1alm/dec(40x40) + 1alm/rim(50x30)
 Módulo 298 - 2ass(116) + 2br(33) + 2alm/enc(100x50) + 1alm/dec(40x40) + 1alm/rim(50x30)

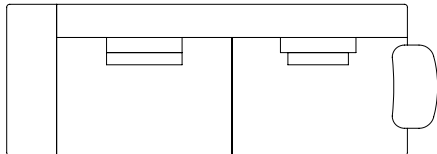

Configurações com 2 assentos, 1 braço e 1 mesa

Módulo 195 - 2ass(71) + 1br(33) + 1mesa(30) + 2alm/enc(55x50) + 1alm/dec(40x40) + 1alm/rim(50x30)
 Módulo 225 - 2ass(86) + 1br(33) + 1mesa(30) + 2alm/enc(70x50) + 1alm/dec(40x40) + 1alm/rim(50x30)
 Módulo 255 - 2ass(101) + 1br(33) + 1mesa(30) + 2alm/enc(85x50) + 1alm/dec(40x40) + 1alm/rim(50x30)
 Módulo 285 - 2ass(116) + 1br(33) + 1mesa(30) + 2alm/enc(100x50) + 1alm/dec(40x40) + 1alm/rim(50x30)

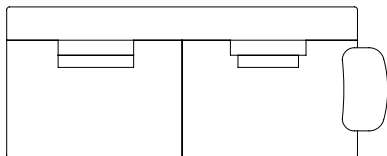

Configurações com 2 assentos e 1 mesa

Módulo 162 - 2ass(71) + 1mesa(30) + 2alm/enc(55x50) + 1alm/dec(40x40) + 1alm/rim(50x30)
 Módulo 192 - 2ass(86) + 1mesa(30) + 2alm/enc(70x50) + 1alm/dec(40x40) + 1alm/rim(50x30)
 Módulo 222 - 2ass(101) + 1mesa(30) + 2alm/enc(85x50) + 1alm/dec(40x40) + 1alm/rim(50x30)
 Módulo 252 - 2ass(116) + 1mesa(30) + 2alm/enc(100x50) + 1alm/dec(40x40) + 1alm/rim(50x30)

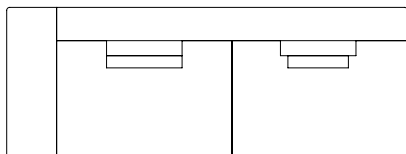

Configurações com 2 assentos e 1 braço

Módulo 175 - 2ass(71) + 1br(33) + 2alm/enc(55x50) + 1alm/dec(40x40) + 1alm/rim(50x30)
 Módulo 205 - 2ass(86) + 1br(33) + 2alm/enc(70x50) + 1alm/dec(40x40) + 1alm/rim(50x30)
 Módulo 235 - 2ass(101) + 1br(33) + 2alm/enc(85x50) + 1alm/dec(40x40) + 1alm/rim(50x30)
 Módulo 265 - 2ass(116) + 1br(33) + 2alm/enc(100x50) + 1alm/dec(40x40) + 1alm/rim(50x30)

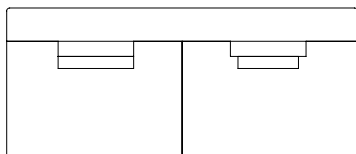

Configurações com 2 assentos e sem braço

Módulo 142 - 2ass(71) + 2alm/enc(55x50) + 1alm/dec(40x40) + 1alm/rim(50x30)
 Módulo 172 - 2ass(86) + 2alm/enc(70x50) + 1alm/dec(40x40) + 1alm/rim(50x30)
 Módulo 202 - 2ass(101) + 2alm/enc(85x50) + 1alm/dec(40x40) + 1alm/rim(50x30)
 Módulo 232 - 2ass(116) + 2alm/enc(100x50) + 1alm/dec(40x40) + 1alm/rim(50x30)

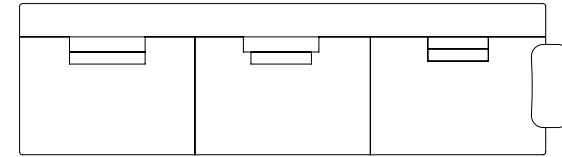

Configuração com 3 assentos e 1 mesa

Módulo 323 - 3ass(101) + 1mesa(30) + 3alm/enc(85x50) + 2alm/dec(40x40) + 1alm/rim(50x30)

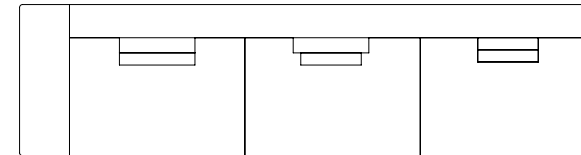

Configuração com 3 assentos e 1 braço

Módulo 336 - 3ass(101) + 1br(33) + 3alm/enc(85x50) + 2alm/dec(40x40) + 1alm/rim(50x30)

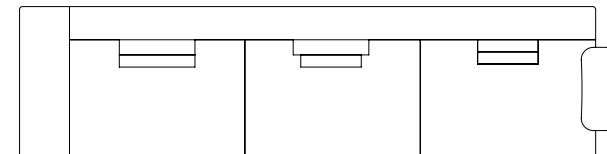

Configuração com 3 assentos, 1 braço e 1 mesa

Módulo 356 - 3ass(101) + 1br(33) + 1mesa(30) + 3alm/enc(85x50) + 2alm/dec(40x40) + 1alm/rim(50x30)

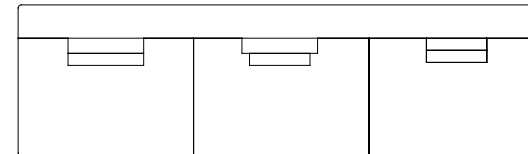

Configuração com 3 assentos e sem braço

Módulo 303 - 3ass(101) + 3alm/enc(85x50) + 2alm/dec(40x40) + 1alm/rim(50x30)

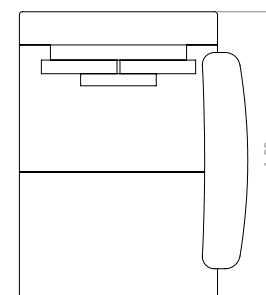

Configurações de Chaise

Chaise 121 - 1ass(101) + 1mesa(30) + 1alm/enc(90x50) + 2alm/dec(40x40) + 1alm/rim(50x30)
 Chaise 151 - 1ass(131) + 1mesa(30) + 1alm/enc(90x50) + 2alm/dec(40x40) + 1alm/rim(50x30)

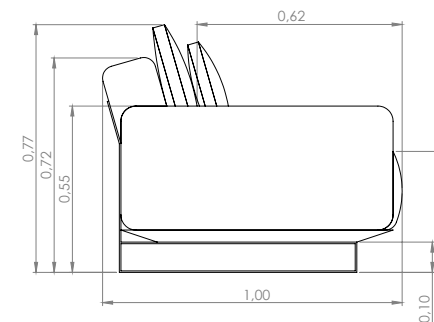



SIRIUS

Design STUDIO FEELING



DESCRIÇÃO DO PRODUTO

ASSENTO: FIXO - MOLA ZIG ZAG + D45 VISCO GEL + HR + D20 SOFT + FIBRA

ENCOSTO: FIXO - D45 VISCO GEL + HR + D33 + D20 SOFT + FIBRA

PÉ/BASE: IMBUÍDA.

OPCIONAIS: CARREGADOR USB NO BRAÇO (CABO DE ALIMENTAÇÃO PARA TOMADA PADRÃO DO BRASIL OU EUA).

DESCRIPTION OF PRODUCT

SEAT: FIXED - ZIG ZAG SPRING + D45 VISCO GEL + HR + D20 SOFT + FIBER

BACKREST: FIXED - D45 VISCO GEL + HR + D33 + D20 SOFT + FIBER

FOOT/BASE: IMBUÍDA.

OPTIONAL: USB CHARGER IN THE ARMREST (POWER CORD TO STANDARD BRAZIL OR US OUTLET).

DESCRIPCIÓN DEL PRODUCTO

ASIENTO: FIJO - RESORTE ZIGZAG + VISCO GEL D45 + HR + D20 SUAVE + FIBRA

RESPALDO: FIJO - D45 VISCO GEL + HR + D33 + D20 SOFT + FIBRA

PIE/BASE: IMBUÍDA.

OPCIONAL: CARGADOR USB EN EL BRAZO (CABLE DE ALIMENTACIÓN A ENCHUFE ESTÁNDAR EN BRASIL O EE. UU.).



Configurações com 1 assento e 1 braço

Módulo 120 - 1ass(95) + 1br(25)
Módulo 140 - 1ass(115) + 1br(25)
Módulo 160 - 1ass(135) + 1br(25)
Módulo 180 - 1ass(155) + 1br(25)

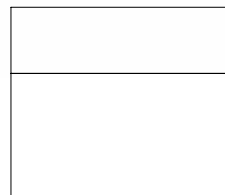

Configurações com 1 assento e sem braço

Módulo 95 - 1ass(95)
Módulo 115 - 1ass(115)
Módulo 135 - 1ass(135)
Módulo 155 - 1ass(155)

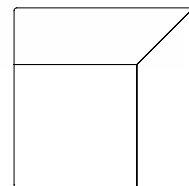

Configuração de Canto

Canto 98 - 1ass(63) + 1br/enc(35)



Configurações de Puff

Puff 95 - 1puff(95x63)
Puff 115 - 1puff(115x63)
Puff 135 - 1puff(135x63)
Puff 155 - 1puff(155x63)
Puff 95 - 1puff(95x98)
Puff 115 - 1puff(115x98)

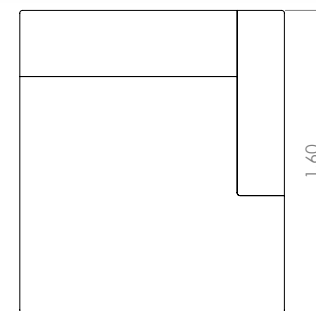

Configurações de Chaise

Chaise 120 - 1ass(95) + 1br(25)
Chaise 150 - 1ass(125) + 1br(25)

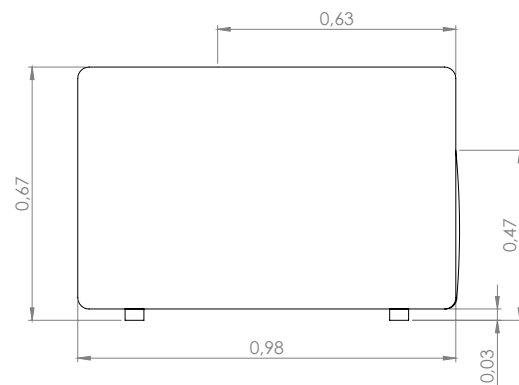

VERSA

Design STUDIO FEELING



DESCRIÇÃO DO PRODUTO

GAVETÃO: FIXO - PERCINTA + D20 SOFT.

ASSENTO: SOLTO - HR + D26 ULTRACEL + FIBRA.

ENCOSTO: FIXO - D20 SOFT.

ALMOFADA DE ENCOSTO: SOLTA - D26 ULTRACEL + D20 SOFT + FIBRA.

ALMOFADA DE BRAÇO: SOLTA - D26 ULTRACEL + D20 SOFT + FIBRA.

PÉS: PINTURA ELETROSTÁTICA - MARROM, CHUMBO OU BLACK.

DETALHES: ZIPPER - BEGE, CINZA, CHUMBO OU PRETO.

DESCRIPCIÓN DEL PRODUCTO

CAJÓN: FIJO - CINTURÓN ELÁSTICO + D20 SUAVE.

ASIENTO: SUELTO - HR + D26 ULTRACEL + FIBRA.

RESPALDO: FIJO - D20 BLANDO.

ALMOHADA DE RESPALDO: SUELTO - D26 ULTRACEL + D20 SOFT + FIBRA.

ALMOHADA DE BRAZO: SUELTO - D26 ULTRACEL + D20 SOFT + FIBRA.

PIES: PINTURA ELECTROSTÁTICA - MARRÓN, PLOMO O NEGRO.

DETALLES: CREMALLERA - BEIGE, GRIS, PLOMO O NEGRO

DESCRIPTION OF PRODUCT

INVOLVING STRUCTURE: FIXED - ELASTIC BELT + D20 SOFT.

SEAT: LOOSE - HR + D26 ULTRACEL + FIBER.

BACKREST: FIXED - D20 SOFT.

BACKREST CUSHION: LOOSE - D26 ULTRACEL + D20 SOFT + FIBER.

ARM CUSHION: LOOSE - D26 ULTRACEL + D20 SOFT + FIBER.

FOOT: ELECTROSTATIC PAINTING - BROWN, LEAD, OR BLACK.

DETAILS: ZIPPER - BEIGE, GRAY, LEAD OR BLACK

VERSA

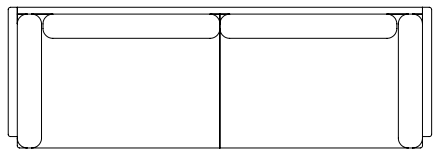

Configurações com 2 assentos e 2 braços

Módulo 220 - 2ass(87) + 2br(5) + 2alm/enc(87x55) + 2alm/br(85x55)

Módulo 260 - 2ass(107) + 2br(5) + 2alm/enc(107x55) + 2alm/br(85x55)

Módulo 280 - 2ass(117) + 2br(5) + 2alm/enc(117x55) + 2alm/br(85x55)

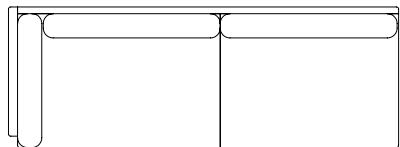

Configurações com 2 assentos e 1 braço

Módulo 197 - 2ass(87) + 1br(5) + 2alm/enc(87x55) + 1alm/br(85x55)

Módulo 237 - 2ass(107) + 1br(5) + 2alm/enc(107x55) + 1alm/br(85x55)

Módulo 257 - 2ass(117) + 1br(5) + 2alm/enc(117x55) + 1alm/br(85x55)

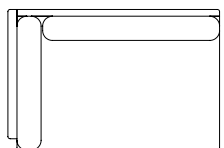

Configurações com 1 assento e 1 braço

Módulo 110 - 1ass(87) + 1br(5) + 1alm/enc(87x55) + 1alm/br(85x55)

Módulo 130 - 1ass(107) + 1br(5) + 1alm/enc(107x55) + 1alm/br(85x55)

Módulo 140 - 1ass(117) + 1br(5) + 1alm/enc(117x55) + 1alm/br(85x55)

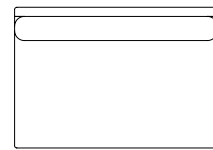

Configurações com 1 assento e sem braço

Módulo 87 - 1ass(87) + 1alm/enc(87x55)

Módulo 107 - 1ass(107) + 1alm/enc(107x55)

Módulo 117 - 1ass(117) + 1alm/enc(117x55)

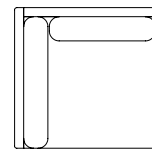

Configuração de Canto

Canto 93 - 1ass(62) + 1br/enc(5) + 1alm/enc(73x55) + 1alm/br(53x55)



Configurações de Puff

Puff 87 - 1puff(87x80)

Puff 107 - 1puff(107x80)

Puff 117 - 1puff(117x80)

Puff canto 93 - 1puff(93x93)

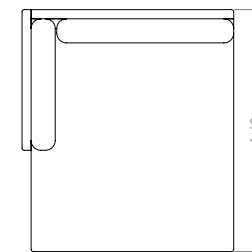

Configurações de Chaise

Chaise 123 - 1ass(100) + 1br(5) + 1alm/enc(100x55) + 1alm/br(85x55)

Chaise 153 - 1ass(130) + 1br(5) + 1alm/enc(130x55) + 1alm/br(85x55)

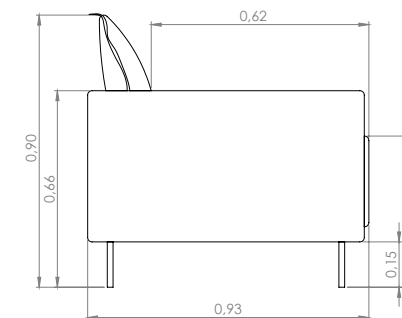

ASPEN

Design PEDRO MENDES



DESCRIÇÃO DO PRODUTO

ASSENTO: FIXO - PERCINTA + HR + D26 ULTRACEL + FIBRA.

ENCOSTO: FIXO - D20 SOFT.

ALMOFADA DE ENCOSTO: SOLTA - D23 HIPER + D26 ULTRACEL + FIBRA.

BASE: LÂMINA NATURAL - CARVALHO NATURAL, CARVALHO EBANIZADO, CARVALHO LINEN OU NOGUEIRA.

MESA: LÂMINA NATURAL - CARVALHO NATURAL, CARVALHO EBANIZADO, CARVALHO LINEN OU NOGUEIRA.

PÉS: PINTURA ELETROSTÁTICA - MARROM, CHUMBO OU BLACK. POLIMENTO - ALUMÍNIO.

OPCIONAIS: CARREGADOR USB NO BRAÇO (CABO DE ALIMENTAÇÃO PARA TOMADA PADRÃO DO BRASIL OU EUA).

OBSERVAÇÕES: AS CONFIGURAÇÕES DE CHAISE TERÃO UMA COSTURA ADICIONAL NA PARTE SUPERIOR DO ASSENTO, DEVIDO AS DIMENÇÕES DO TECIDO.

DESCRIPTION OF PRODUCT

SEAT: FIXED - ELASTIC BELT + HR + D26 ULTRACEL + FIBER.

BACKREST: FIXED - D20 SOFT.

BACKREST CUSHION: LOOSE - D23 HYPER + D26 ULTRACEL + FIBER.

BASE: NATURAL VENEER - NATURAL OAK, EBONIZED OAK, OAK LINEN OR WALNUT.

TABLE: NATURAL VENEER - NATURAL OAK, EBONY OAK, LINEN OAK OR WALNUT.

FOOT: ELECTROSTATIC PAINT - BROWN, LEAD, OR BLACK. POLISHING - ALUMINUM.

OPTIONAL: USB CHARGER IN THE ARMREST (POWER CORD TO STANDARD BRAZIL OR US OUTLET).

REMARKS: THE CHAISE CONFIGURATIONS WILL HAVE AN ADDITIONAL SEAM ON THE TOP OF THE SEAT, DUE TO THE DIMENSIONS OF THE FABRIC.

DESCRIPCIÓN DEL PRODUCTO

ASIENTO: FIJO - CINTURÓN ELÁSTICO + HR + D26 ULTRACEL + FIBRA.

RESPALDO: FIJO - D20 SUAVE.

ALMOHADA DE RESPALDO: SUELTO - D23 HIPER + D26 ULTRACEL + FIBRA

BASE: CHAPA NATURAL - ROBLE NATURAL, ROBLE EBONIZADO, ROBLE LINO O NOGAL

MESA: CHAPA NATURAL - ROBLE NATURAL, ROBLE EBANIZADO, ROBLE LINO O NOGAL

PIÉS: PINTURA ELECTROSTÁTICA - MARRÓN, PLOMO O NEGRA PULIDO - ALUMINIO

OPCIONAL: CARGADOR USB EN EL BRAZO (CABLE DE ALIMENTACIÓN A ENCHUFE ESTÁNDAR EN BRASIL O EE. UU.).

OBSERVACIONES: LAS CONFIGURACIONES DE CHAISE TENDRÁN UNA COSTURA ADICIONAL EN LA PARTE SUPERIOR DEL ASIENTO, DEBIDO A LAS DIMENSIONES DEL TEJIDO.

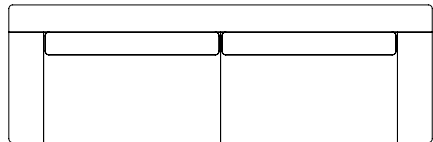

Configurações com 2 assentos e 2 braços

Módulo 242 - 2ass(101) + 2br(20) + 2alm/enc(101x45)

Módulo 280 - 2ass(120) + 2br(20) + 2alm/enc(120x45)

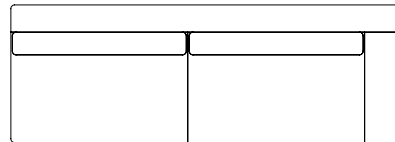

Configurações com 2 assentos e 1 braço

Módulo 222 - 2ass(101) + 1br(20) + 2alm/enc(101x45)

Módulo 260 - 2ass(120) + 1br(20) + 2alm/enc(120x45)

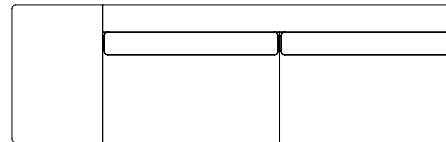

Configurações com 2 assentos e 1 mesa

Módulo 262 - 2ass(101) + 1mesa(60) + 2alm/enc(101x45)

Módulo 300 - 2ass(120) + 1mesa(60) + 2alm/enc(120x45)

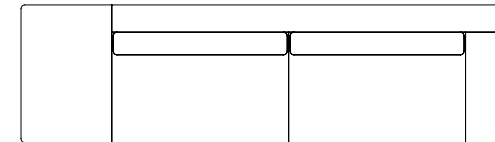

Configurações com 2 assentos, 1 braço e 1 mesa

Módulo 282 - 2ass(101) + 1br(20) + 1mesa(60) + 2alm/enc(101x45)

Módulo 320 - 2ass(120) + 1br(20) + 1mesa(60) + 2alm/enc(120x45)

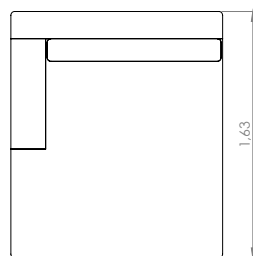
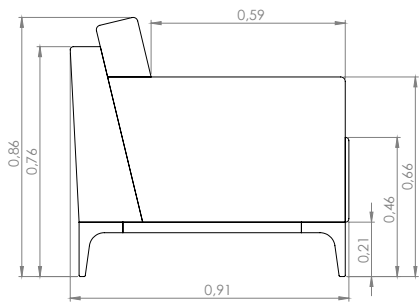

Configurações de Chaise

Chaise 120 - 1ass(100) + 1br(20) + 1alm/enc(100x45)

Chaise 140 - 1ass(120) + 1br(20) + 1alm/enc(120x45)



ASPEN



STONE

Design STUDIO FEELING



DESCRIÇÃO DO PRODUTO

ASSENTO: FIXO - PERCINTA + HR + D26 ULTRACEL + D20 SOFT + FIBRA.

ENCOSTO: FIXO - D33 + D20 SOFT + FIBRA.

ALMOFADA DECORATIVA: SOLTA - FIBRA SILICONADA.

PÉ: IMBUÍDA.

OBSERVAÇÕES: PRODUTO INDISPONÍVEL EM COURO E COURO SINTÉTICO.

A PROFUNDIDADE TOTAL DO PRODUTO VARIA A CADA CONFIGURAÇÃO.

DESCRIPTION OF PRODUCT

SEAT: FIXED - ELASTIC BELT + HR + D26 ULTRACEL + D20 SOFT + FIBER.

BACKREST: FIXED - D33 + D20 SOFT + FIBER.

DECORATIVE CUSHION: LOOSE - SILICONED FIBER.

FOOT: IMBUÍDA.

NOTE: PRODUCT UNAVAILABLE IN LEATHER AND SYNTHETIC LEATHER.

THE TOTAL DEPTH OF THE PRODUCT VARIES WITH EACH CONFIGURATION.

DESCRIPCIÓN DEL PRODUCTO

ASIENTO: FIJO - CINTURÓN ELÁSTICO + HR + D26 ULTRACEL + D20 SOFT + FIBRA.

RESPALDO: FIJO - D33 + D20 BLANDO + FIBRA.

ALMOHADA DECORATIVA: SUELTO - FIBRA DE SILICONA.

PIE: IMBUÍDA.

OBSERVACIONES: PRODUCTO NO DISPONIBLE EN PIEL Y PIEL SINTÉTICO.

LA PROFUNDIDAD TOTAL DEL PRODUCTO VARÍA CON CADA CONFIGURACIÓN.

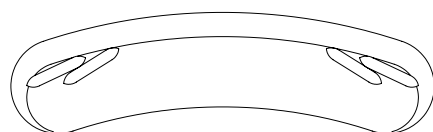

Configurações com 1 assento e 2 braços

Módulo 180 - 1ass(150) + 2br(15) + 4alm/dec(45x45)

Módulo 220 - 1ass(190) + 2br(15) + 4alm/dec(45x45)

Módulo 240 - 1ass(210) + 2br(15) + 4alm/dec(45x45)

Módulo 280 - 1ass(250) + 2br(15) + 4alm/dec(45x45)

Módulo 320 - 1ass(290) + 2br(15) + 4alm/dec(45x45)

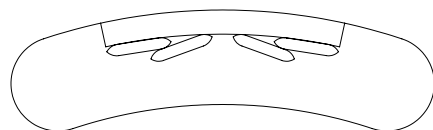
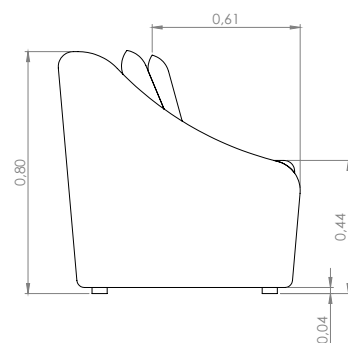

Configurações com 1 assento e 2 puff's

Módulo 180 - 1ass(60) + 2puff(60) + 4alm/dec(45x45)

Módulo 220 - 1ass(100) + 2puff(60) + 4alm/dec(45x45)

Módulo 240 - 1ass(120) + 2puff(60) + 4alm/dec(45x45)

Módulo 280 - 1ass(160) + 2puff(60) + 4alm/dec(45x45)

Módulo 320 - 1ass(200) + 2puff(60) + 4alm/dec(45x45)



Configurações com 1 assento e 1 braço

Módulo 160 - 1ass(145) + 1br(15) + 2alm/dec(45x45)

Módulo 180 - 1ass(165) + 1br(15) + 2alm/dec(45x45)

Módulo 220 - 1ass(205) + 1br(15) + 2alm/dec(45x45)

Módulo 260 - 1ass(245) + 1br(15) + 2alm/dec(45x45)

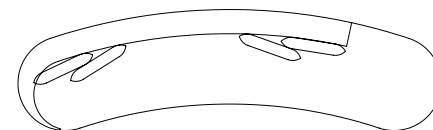

Configurações com 1 assento, 1 braço e 1 puff

Módulo 180 - 1ass(105) + 1br(15) + 1puff(60) + 4alm/dec(45x45)

Módulo 220 - 1ass(145) + 1br(15) + 1puff(60) + 4alm/dec(45x45)

Módulo 240 - 1ass(165) + 1br(15) + 1puff(60) + 4alm/dec(45x45)

Módulo 280 - 1ass(205) + 1br(15) + 1puff(60) + 4alm/dec(45x45)

Módulo 320 - 1ass(245) + 1br(15) + 1puff(60) + 4alm/dec(45x45)



Configurações com 1 assento e 1 puff

Módulo 160 - 1ass(100) + 1puff(60) + 2alm/dec(45x45)

Módulo 180 - 1ass(120) + 1puff(60) + 2alm/dec(45x45)

Módulo 220 - 1ass(160) + 1puff(60) + 2alm/dec(45x45)

Módulo 260 - 1ass(200) + 1puff(60) + 2alm/dec(45x45)



Configuração de Almofada

Alm/dec(45x45)

STONE



MOON

Design STUDIO FEELING



DESCRIÇÃO DO PRODUTO

ASSENTO: FIXO - PERCINTA + D33 + D26 ULTRACEL + D20 SOFT + FIBRA.

ENCOSTO: FIXO - D20 SOFT.

ALMOFADA DE ENCOSTO: SOLTA - D26 ULTRACEL + D23 HIPER + D20 SOFT.

PÉS: PINTURA ELETROSTÁTICA- CHUMBO, MARROM OU BLACK. POLIDO - ALUMÍNIO.

OBSERVAÇÃO: PRODUTO INDISPONÍVEL EM COURO.

DESCRIPTION OF PRODUCT

SEAT: FIXED - ELASTIC BELT + D33 + D26 ULTRACEL + D20 SOFT + FIBER.

BACKREST: FIXED - D20 SOFT.

BACKREST CUSHION: LOOSE - D26 ULTRACEL + D23 HYPER + D20 SOFT.

FOOT: ELECTROSTATIC PAINTING - LEAD, BROWN OR BLACK.

POLISHED - ALUMINUM.

NOTE: PRODUCT NOT AVAILABLE IN LEATHER.

DESCRIPCIÓN DEL PRODUCTO

ASIENTO: FIJO - CINTURÓN ELÁSTICO + D33 + D26 ULTRACEL + D20 SOFT + FIBRA.

RESPALDO: FIJO - D20 BLANDO.

ALMOHADA DE RESPALDO: SUELTO - D26 ULTRACEL + D23 HIPER + D20 SOFT.

PIES: PINTURA ELECTROSTÁTICA - PLOMO, MARRÓN O NEGRO. PULIDO - ALUMINIO.

NOTA: PRODUCTO NO DISPONIBLE EN PIEL.

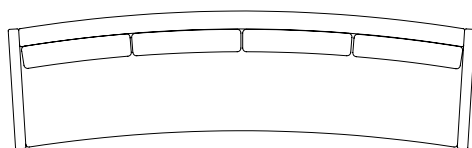

Configurações com 1 assento, 2 braços e 4 almofadas

Módulo 320 - 1ass(304) + 2br(8) + 4alm/enc(75x42)

Módulo 368 - 1ass(352) + 2br(8) + 4alm/enc(87x42)

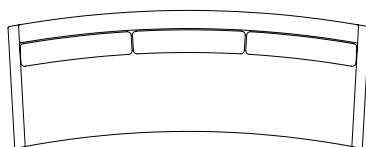

Configurações com 1 assento, 2 braços e 3 almofadas

Módulo 240 - 1ass(224) + 2br(8) + 3alm/enc(73x42)

Módulo 280 - 1ass(264) + 2br(8) + 3alm/enc(86x42)

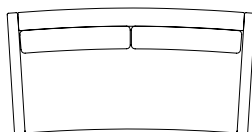

Configurações com 1 assento, 2 braços e 2 almofadas

Módulo 180 - 1ass(164) + 2br(8) + 2alm/enc(80x42)

Módulo 220 - 1ass(204) + 2br(8) + 2alm/enc(104x42)

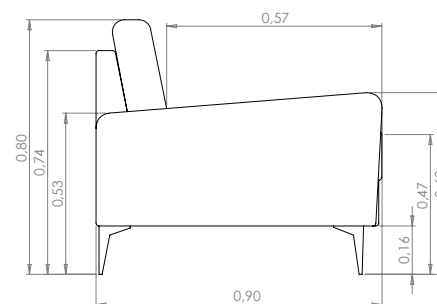

MOON



MOBE

Design STUDIO FEELING



DESCRIÇÃO DO PRODUTO

ASSENTO: FIXO - PERCINTA + D33 + FIBRA.

ROLINHO ENCOSTO: SOLTO - D33 + FIBRA.

ALMOFADA DE ENCOSTO: SOLTA - D26 ULTRACEL + ALGODÃO + FIBRA.

PÉ: IMBUÍDA.

OBSERVAÇÕES: PRODUTO INDISPONÍVEL EM COURO NAS CONFIGURAÇÕES DE PUFF LISO.

DESCRIPTION OF PRODUCT

SEAT: FIXED - ELASTIC BELT + D33 + FIBER.

BACKREST ROLL CUSHION: LOOSE - D33 + FIBER.

BACKREST CUSHION: LOOSE - D26 ULTRACEL + COTTON + FIBER.

FOOT: IMBUÍDA.

NOTE: PRODUCT UNAVAILABLE IN LEATHER IN SMOOTH PUFF CONFIGURATIONS.

DESCRIPCIÓN DEL PRODUCTO

ASIENTO: FIJO - CINTURÓN ELÁSTICO + D33 + FIBRA.

ALMOHADA ROLLITO DE RESPALDO: SUELTO - D33 + FIBRA.

ALMOHADA DE RESPALDO: SUELTO - D26 ULTRACEL + ALGODÓN + FIBRA.

PIE: IMBUÍDA.

OBSERVACIONES: PRODUCTO NO DISPONIBLE EN PIEL EN CONFIGURACIONES DE PUFF LISO.

MOBE

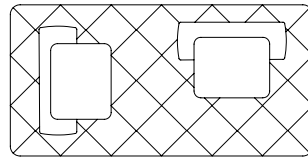

Configurações de Puff Captonê

Puff 160 - 1 puff/cap(160x100) + 2rol/enc(72x25) + 2alm/enc(55x55)

Puff 200 - 1 puff/cap(200x100) + 2rol/enc(72x25) + 2alm/enc(55x55)

Puff 240 - 1 puff/cap(240x100) + 2rol/enc(72x25) + 2alm/enc(55x55)

Puff 280 - 1 puff/cap(280x100) + 3rol/enc(72x25) + 3alm/enc(55x55)

Puff 320 - 1 puff/cap(320x100) + 3rol/enc(72x25) + 3alm/enc(55x55)

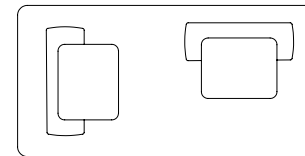
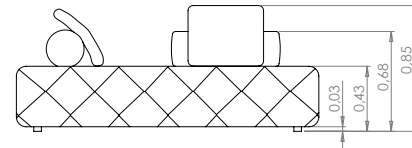

Configurações de Puff Liso

Puff 160 - 1 puff/liso(160x100) + 2rol/enc(72x25) + 2alm/enc(55x55)

Puff 200 - 1 puff/liso(200x100) + 2rol/enc(72x25) + 2alm/enc(55x55)

Puff 240 - 1 puff/liso(240x100) + 2rol/enc(72x25) + 2alm/enc(55x55)

Puff 280 - 1 puff/liso(280x100) + 3rol/enc(72x25) + 3alm/enc(55x55)

Puff 320 - 1 puff/liso(320x100) + 3rol/enc(72x25) + 3alm/enc(55x55)



Configuração de Almofada

Alm/enc(55x55)

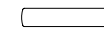

Configuração de Rolinho

Rol/enc(72x25)



CLUB

Design STUDIO FEELING



DESCRIÇÃO DO PRODUTO

ASSENTO: SOLTO - PERCINTA + HR + D26 ULTRACEL + FIBRA.

ENCOSTO: FIXO - D20 SOFT.

ALMOFADA DE ENCOSTO: SOLTA - D26 ULTRACEL + D20 SOFT + FIBRA.

PÉ: PINTURA ELETROSTÁTICA - CHUMBO, MARROM OU BLACK.

OBSERVAÇÕES: AS ALMOFADAS DE ASSENTO E ENCOSTO NÃO POSSUEM ZÍPER.

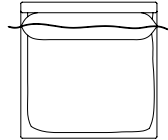

Configurações com 1 assento e 1 almofada encosto

Módulo 87 - 1ass(87) + 1alm/enc(87x55)

Módulo 107 - 1ass(107) + 1alm/enc(107x55)

Módulo 117 - 1ass(117) + 1alm/enc(117x55)

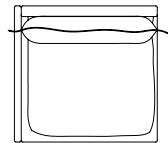

Configurações com 1 assento, 1 almofada encosto e 1 braço

Módulo 92 - 1ass(87) + 1br(5) + 1alm/enc(87x55)

Módulo 112 - 1ass(107) + 1br(5) + 1alm/enc(107x55)

Módulo 122 - 1ass(117) + 1br(5) + 1alm/enc(117x55)

DESCRIPTION OF PRODUCT

SEAT: LOOSE - ELASTIC BELT + HR + D26 ULTRACEL + FIBER.

BACKREST: FIXED - D20 SOFT

BACKREST CUSHION: LOOSE - D26 ULTRACEL + D20 SOFT + FIBER

FOOT: ELECTROSTATIC PAINTING - LEAD, BROWN OR BLACK.

NOTE: SEAT CUSHIONS DO NOT HAVE ZIPPER

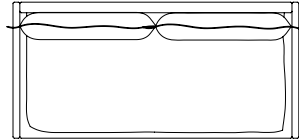

Configurações com 1 assento, 2 almofadas encosto e 2 braços

Módulo 184 - 1ass(174) + 2br(5) + 2alm/enc(87x55)

Módulo 224 - 1ass(214) + 2br(5) + 2alm/enc(107x55)

Módulo 244 - 1ass(234) + 2br(5) + 2alm/enc(117x55)

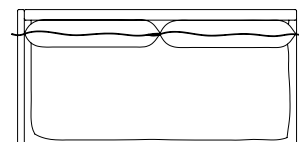

Configurações com 1 assento, 2 almofadas encosto e 1 braço

Módulo 179 - 1ass(174) + 1br(5) + 2alm/enc(87x55)

Módulo 219 - 1ass(214) + 1br(5) + 2alm/enc(107x55)

Módulo 239 - 1ass(234) + 1br(5) + 2alm/enc(117x55)

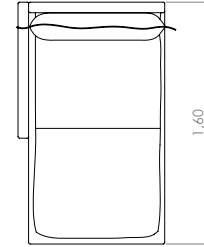

Configurações de Chaise

Chaise 92 - 1ass(87) + 1br(5) + 1alm/enc(87x55)

Chaise 122 - 1ass(117) + 1br(5) + 1alm/enc(117x55)

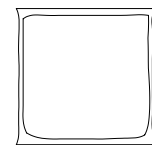

Configurações de Puff

Puff canto 93 - 1puff canto(93x93)

Puff 87 - 1puff(87x93)

Puff 107 - 1puff(107x93)

Puff 117 - 1puff(117x93)

DESCRIPCIÓN DEL PRODUCTO

ASIENTO: FIJO - CINTURÓN ELÁSTICO + HR + D26 ULTRACEL + FIBRA.

RESPALDO: FIJO - D20 SUAVE

ALMOHADA DE RESPALDO: SUELTO - D26 ULTRACEL + D20 SUAVE + FIBRA.

PIES: PINTURA ELECTROSTÁTICA - PLOMO, MARRÓN O NEGRO.

OBSERVACIONES: ALMOHADAS DE ASIENTO NO TIENEN CREMALLERA

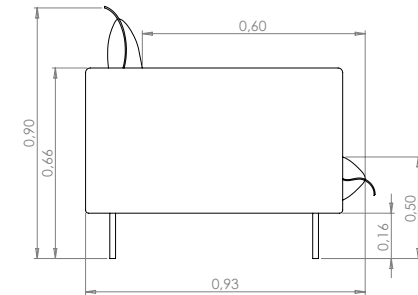

CLUB



HOME

Design STUDIO FEELING



DESCRIÇÃO DO PRODUTO

ASSENTO: FIXO - MOLA + D26 ULTRACEL + HR + D20 SOFT + FIBRA.

ENCOSTO: FIXO - D20 SOFT.

ALMOFADA DE ENCOSTO: SOLTA - FIBRA SILICONADA + FIBRA.

ALMOFADA DE RIM: SOLTA - FIBRA SILICONADA + FIBRA.

ESTRUTURA BRAÇO/ENCOSTO: PINTURA ELETROSTÁTICA - CHUMBO, MARROM OU BLACK.

PÉ: IMBUÍA.

OBSERVAÇÃO: PEÇAS ESPECIAIS LIMITAM-SE A 1,30M DE LARGURA MÁXIMA.

DESCRIPTION OF PRODUCT

SEAT: FIXED - SPRING + D26 ULTRACEL + HR + D20 SOFT + FIBER.

BACKREST: FIXED - D20 SOFT.

BACKREST CUSHION: LOOSE - SILICONIZED FIBER + FIBER.

LUMBAR CUSHION: LOOSE - SILICONIZED FIBER + FIBER.

ARM/BACK STRUCTURE: ELECTROSTATIC PAINTING - LEAD, BROWN OR BLACK.

FOOT: IMBUÍA.

NOTE: SPECIAL PIECES ARE LIMITED TO A MAXIMUM WIDTH OF 1.30M

DESCRIPCIÓN DEL PRODUCTO

ASIENTO: FIJO - RESORTE + D26 ULTRACEL + HR + D20 SOFT + FIBRA.

RESPALDO: FIJO - D20 BLANDO.

ALMOHADA DE RESPALDO: SUELTO - FIBRA SILICONADA + FIBRA.

ALMOHADA ESPALDA BAJA: SUELTO - FIBRA SILICONADA + FIBRA.

ESTRUTURA DEL BRAZO/ESPALDA: PINTURA ELECTROSTÁTICA - PLOMO, MARRÓN O NEGRO.

PIE: IMBUÍA.

NOTA: LAS PIEZAS ESPECIALES ESTÁN LIMITADAS A UNA ANCHURA MÁXIMA DE 1,30 M

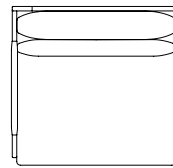

Configurações com 1 assento e 1 braço

Módulo 90 - 1ass(85) + 1br(5) + 1alm/enc(85x50) + 1alm/rim(70x40)

Módulo 110 - 1ass(105) + 1br(5) + 1alm/enc(105x50) + 1alm/rim(90x40)

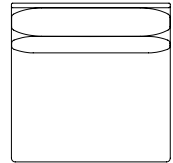

Configurações com 1 assento e sem braço

Módulo 85 - 1ass(85) + 1alm/enc(85x50) + 1alm/rim(70x40)

Módulo 105 - 1ass(105) + 1alm/enc(105x50) + 1alm/rim(90x40)

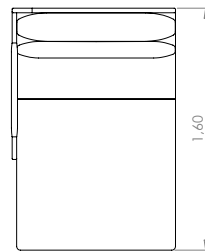

Configurações de Chaise

Chaise 110 - 1ass(105) + 1br(5) + 1alm/enc(105x50) + 1alm/rim(85x40)

Chaise 130 - 1ass(125) + 1br(5) + 1alm/enc(125x50) + 1alm/rim(105x40)

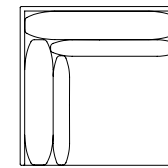

Configuração de Canto

Canto 105 - 1ass(95) + 1br/enc(10) + 1alm/enc(95x50)

+ 1alm/enc(65x50) + 1alm/rim(72x40) + 1alm/rim(47x40)



Configurações de Puff

Puff 85 - 1puff(85x95)

Puff 105 - 1puff(105x95)

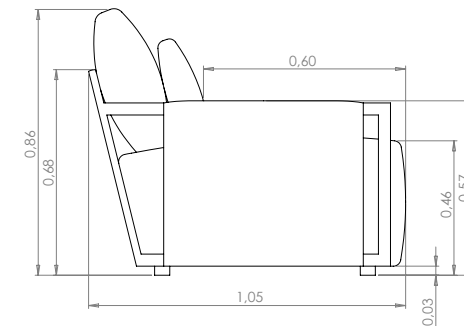

HOME



DROP

Design STUDIO FEELING



DESCRIÇÃO DO PRODUTO

ASSENTO: FIXO - MOLA + D33 + D26 ULTRACEL + FIBRA.

ENCOSTO: FIXO - PERCINTA + D33.

ALMOFADA DE ENCOSTO: SOLTA - D23 HIPER + FIBRA.

PÉ: PINTURA ELETROSTÁTICA - CHUMBO, MARROM OU BLACK.

OBSERVAÇÕES: AS OPÇÕES BIPARTIDAS
SERÃO ENVIADAS COM A BASE INTEIRA.

DESCRIPTION OF PRODUCT

SEAT: FIXED - SPRING + D33 + D26 ULTRACEL + FIBER.

BACKREST: FIXED - ELASTIC BELT + D33.

BACKREST CUSHION: LOOSE - D23 HYPER + FIBER.

FOOT: ELECTROSTATIC PAINTING - LEAD, BROWN OR BLACK.

OBSERVATIONS: SPLIT OPTIONS WILL BE SHIPPED WITH THE ENTIRE BASE.

DESCRIPCIÓN DEL PRODUCTO

ASIENTO: FIJO - RESORTE + D33 + D26 ULTRACEL + FIBRA.

RESPALDO: FIJO - CINTURÓN ELÁSTICO + D33.

ALMOHADA DE RESPALDO: SUELTO - D23 HIPER + FIBRA.

PIE: PINTURA ELECTROSTÁTICA - PLOMO, MARRÓN O NEGRO.

OBSERVACIONES: LAS OPCIONES BIPARTITAS SE ENVIARÁN CON LA BASE
COMPLETA.

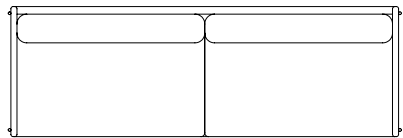

Configurações com 2 assentos e 2 braços

Módulo 220 - 2ass(106) + 2br(4) + 2alm/enc(106x40)

Módulo 240 - 2ass(116) + 2br(4) + 2alm/enc(116x40)

Módulo 260 - 2ass(126) + 2br(4) + 2alm/enc(126x40)

Módulo 280 - 2ass(136) + 2br(4) + 2alm/enc(136x40)

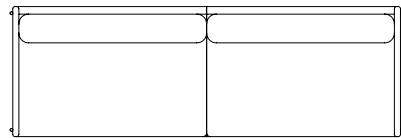

Configurações bipartidas com 2 assentos e 2 braços

Módulo bipartido 220 - 2ass(106) + 2br(4) + 2alm/enc(106x40)

Módulo bipartido 240 - 2ass(116) + 2br(4) + 2alm/enc(116x40)

Módulo bipartido 260 - 2ass(126) + 2br(4) + 2alm/enc(126x40)

Módulo bipartido 280 - 2ass(136) + 2br(4) + 2alm/enc(136x40)

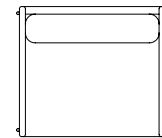

Configuração de Poltrona

Poltrona 91 - 1ass(83) + 2br(4) + 1alm/dec(83x40)

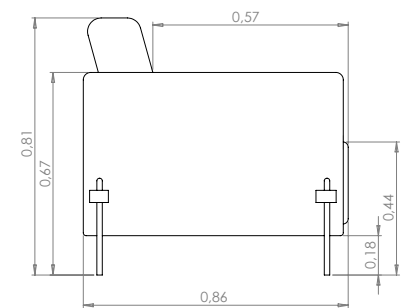

DROP



TREND

Design STUDIO FEELING



DESCRIÇÃO DO PRODUTO

ASSENTO: FIXO - PERCINTA + D26 ULTRACEL + HR + D33 + FIBRA.

ENCOSTO: FIXO -D33 + D20 SOFT + FIBRA.

ALMOFADA DE ENCOSTO: SOLTA - FIBRA SILICONADA.

ALMOFADA DECORATIVA: SOLTA - FIBRA SILICONADA.

PÉ: PINTURA ELETROSTÁTICA - CHUMBO, MARROM OU BLACK.

OPCIONAIS: CARREGADOR USB NO BRAÇO (CABO DE ALIMENTAÇÃO PARA TOMADA PADRÃO DO BRASIL OU EUA).

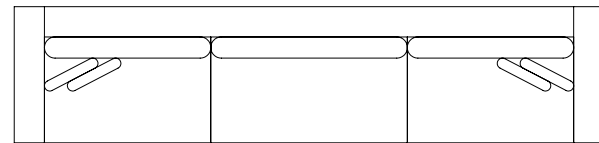

Configuração com 3 assentos e 2 braços

Módulo 310 - 3ass(90) + 2br(20) + 3alm/enc(90x60) + 4alm/dec(50x50)

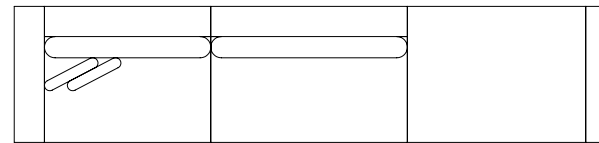

Configurações com 2 assentos, 1 puff, 1 braço e com detalhe

Módulo 270 - 2ass(80) + 1puff(80) + 1br(20) + 1det(10) + 2alm/enc(80x60) + 2alm/dec(50x50)

Módulo 300 - 2ass(90) + 1puff(90) + 1br(20) + 1det(10) + 2alm/enc(90x60) + 2alm/dec(50x50)

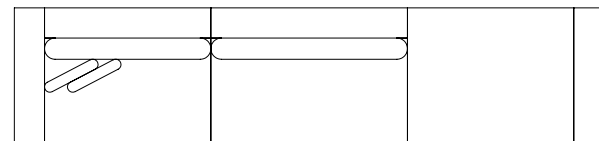

Configurações com 2 assentos, 1 puff, 1 braço e 1 encosto invertido

Módulo 275 - 2ass(80) + 1puff(80) + 1br(20) + 1enc/inv(15) + 2alm/enc(80x60) + 2alm/dec(50x50)

Módulo 305 - 2ass(90) + 1puff(90) + 1br(20) + 1enc/inv(15) + 2alm/enc(90x60) + 2alm/dec(50x50)

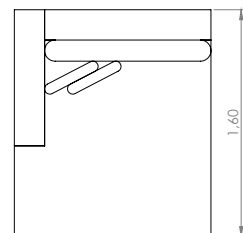

Configurações de Chaise

Chaise 120 - 1ass(100) + 1br(20) + 1alm/enc(100x60) + 2alm/dec(50x50)

Chaise 140 - 1ass(120) + 1br(20) + 1alm/enc(120x60) + 2alm/dec(50x50)

DESCRIPTION OF PRODUCT

SEAT: FIXED - ELASTIC BELT + D26 ULTRACEL + HR + D33 + FIBER.

BACKREST: FIXED -D33 + D20 SOFT + FIBER.

BACKREST CUSHION: LOOSE - SILICONED FIBER.

DECORATIVE CUSHION: LOOSE - SILICONED FIBER.

FOOT: ELECTROSTATIC PAINTING - LEAD, BROWN OR BLACK.

OPTIONAL: USB CHARGER IN THE ARMREST (POWER CORD TO STANDARD BRAZIL OR US OUTLET).

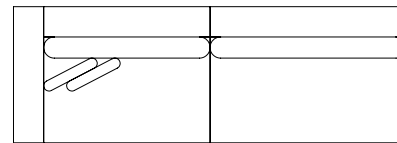

Configurações com 2 assentos e 1 braço

Módulo 180 - 2ass(80) + 1br(20) + 2alm/enc(80x60) + 2alm/dec(50x50)

Módulo 200 - 2ass(90) + 1br(20) + 2alm/enc(90x60) + 2alm/dec(50x50)

Módulo 220 - 2ass(100) + 1br(20) + 2alm/enc(100x60) + 2alm/dec(50x50)

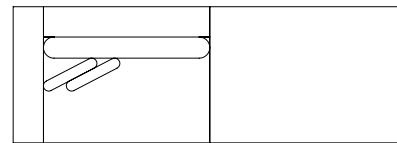

Configurações com 1 assento, 1 puff e 1 braço

Módulo 180 - 1ass(80) + 1puff(80) + 1br(20) + 1alm/enc(80x60) + 2alm/dec(50x50)

Módulo 200 - 1ass(90) + 1puff(90) + 1br(20) + 1alm/enc(90x60) + 2alm/dec(50x50)

Módulo 220 - 1ass(100) + 1puff(100) + 1br(20) + 1alm/enc(100x60) + 2alm/dec(50x50)



Configurações de puff com detalhe

Puff 90 - 1puff(80x96) + 1det(10)

Puff 100 - 1puff(90x96) + 1det(10)

Puff 110 - 1puff(100x96) + 1det(10)

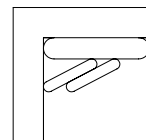

Configuração de Canto

Canto 96 - 1ass(80) + 1br/enc(16)
+ 1alm/enc(80x60) + 2alm/dec(50x50)

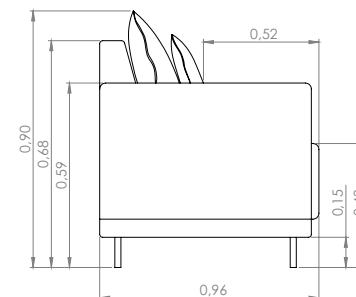

DESCRIPCIÓN DEL PRODUCTO

ASIENTO: FIJO - CINTURÓN ELÁSTICO + D26 ULTRACEL + HR + D33 + FIBRA.

RESPALDO: FIJO - D33 + D20 BLANDO + FIBRA.

ALMOHADA DE RESPALDO: SUELTO - FIBRA SILICONADA.

ALMOHADA DECORATIVA: SUELTA - FIBRA SILICONADA.

PIE: PINTURA ELECTROSTÁTICA - PLOMO, MARRÓN O NEGRO.

OPCIONAL: CARGADOR USB EN EL BRAZO (CABLE DE ALIMENTACIÓN A ENCHUFE ESTÁNDAR EN BRASIL O EE. UU.).



Configurações de Puff

Puff 80 - 1puff(80x96)

Puff 90 - 1puff(90x96)

Puff 100 - 1puff(100x96)

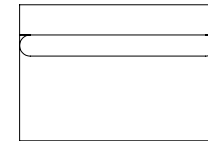

Configurações com 1 assento e sem braço

Módulo 80 - 1ass(80) + 1alm/enc(80x60)

Módulo 90 - 1ass(90) + 1alm/enc(90x60)

Módulo 100 - 1ass(100) + 1alm/enc(100x60)

TREND



ZURIQUE

Design STUDIO FEELING



DESCRIÇÃO DO PRODUTO

ASSENTO: FIXO - PERCINTA + D33 + D20 SOFT + FIBRA.

ENCOSTO: FIXO - PERCINTA + D20 SOFT.

ALMOFADA DE ENCOSTO: SOLTA - D23 HIPER + FIBRA.

PÉ: PRETO.

MESA: LÂMINA NATURAL - CARVALHO NATURAL, CARVALHO EBANIZADO, CARVALHO LINEN OU NOGUEIRA.

PINTURA LACA: BRANCO, PRETO, FENDI OU NUDE.

PERFIL: POLIDO - ALUMÍNIO.

OPCIONAIS: CARREGADOR USB NO BRAÇO (CABO DE ALIMENTAÇÃO PARA TOMADA PADRÃO DO BRASIL OU EUA).

OBSERVAÇÕES: AS ALMOFADAS DE ENCOSTO SÃO FIXAS QUANDO REVESTIDO EM COURO.

O PERFIL DE ALUMÍNIO NÃO SERÁ DISPONIBILIZADO QUANDO O SOFÁ FOR REVESTIDO EM COURO.

DESCRIPTION OF PRODUCT

SEAT: FIXED – ELASTIC BELT + D33 + D20 SOFT + FIBER.

BACKREST: FIXED – ELASTIC BELT + D20 SOFT.

BACKREST CUSHION: LOOSE - D23 HYPER + FIBER.

FOOT: BLACK.

TABLE: NATURAL VENEER - NATURAL OAK, EBONIZED OAK, OAK LINEN OR WALNUT.

LACQUER PAINT: WHITE, BLACK, FENDI OR NUDE.

PROFILE: POLISHED - ALUMINUM.

OPTIONAL: USB CHARGER IN THE ARMREST (POWER CORD TO STANDARD BRAZIL OR US OUTLET).

NOTE: BACKREST CUSHIONS ARE FIXED WHEN COVERED IN LEATHER. THE ALUMINUM PROFILE WILL NOT BE AVAILABLE WHEN THE SOFA IS COVERED IN LEATHER

DESCRIPCIÓN DEL PRODUCTO

ASIENTO: FIJO – CINTURÓN ELÁSTICO + D33 + D20 SUAVE + FIBRA.

RESPALDO: FIJO – CINTURÓN ELÁSTICO + D20 SUAVE.

ALMOHADA DE RESPALDO: SUELTO - D23 HIPER + FIBRA.

PIE: NEGRO.

MESA: CHAPA NATURAL - ROBLE NATURAL, ROBLE EBONIZADO, ROBLE LINO O NOGAL.

LACA DE PINTURA: BLANCA, NEGRA, FENDI O NUDE.

PERFIL: PULIDO - ALUMINIO.

OPCIONAL: CARGADOR USB EN EL BRAZO (CABLE DE ALIMENTACIÓN A ENCHUFE ESTÁNDAR EN BRASIL O EE. UU.).

OBSERVACIONES: LAS ALMOHADAS DE RESPALDO SON FIJOS CUANDO ESTÁN CUBIERTOS DE PIEL.

EL PERFIL DE ALUMINIO NO ESTARÁ DISPONIBLE CUANDO EL SOFÁ ESTÉ RECUBIERTO DE PIEL.

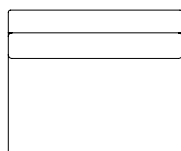

Configurações com 1 assento e sem braço

Módulo 100 - 1ass(100) + 1alm/enc(100x48)
Módulo 115 - 1ass(115) + 1alm/enc(115x48)

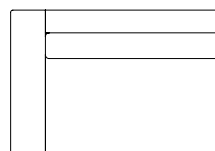

Configuração com 1 assento e 1 braço

Módulo 123 - 1ass(100) + 1br(23) + 1alm/enc(100x48)
Módulo 138 - 1ass(115) + 1br(23) + 1alm/enc(115x48)

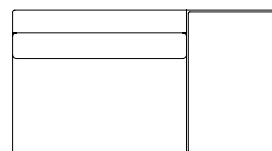

Configurações com 1 assento, 1 mesa e sem braço

Módulo 160 - 1ass(100) + 1mesa(60) + 1alm/enc(100x48)
Módulo 175 - 1ass(115) + 1mesa(60) + 1alm/enc(115x48)

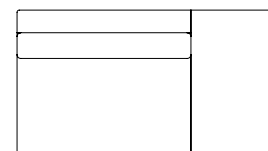

Configurações com 1 assento, 1 puff e sem braço

Módulo 160 - 1ass(100) + 1puff(60) + 1alm/enc(100x48)
Módulo 175 - 1ass(115) + 1puff(60) + 1alm/enc(115x48)

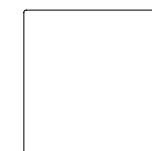

Configuração de mesa canto

Canto 95 - 1mesa(95x95)

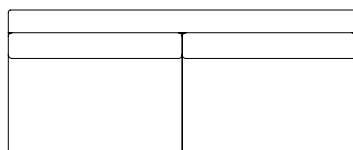

Configurações com 2 assentos e sem braço

Módulo 170 - 2ass(85) + 2alm/enc(85x48)
Módulo 200 - 2ass(100) + 2alm/enc(100x48)
Módulo 230 - 2ass(115) + 2alm/enc(115x48)

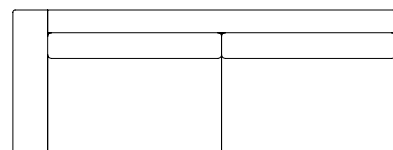

Configurações com 2 assentos e 1 braço

Módulo 163 - 2ass(70) + 1br(23) + 2alm/enc(70x48)
Módulo 193 - 2ass(85) + 1br(23) + 2alm/enc(85x48)
Módulo 223 - 2ass(100) + 1br(23) + 2alm/enc(100x48)
Módulo 253 - 2ass(115) + 1br(23) + 2alm/enc(115x48)

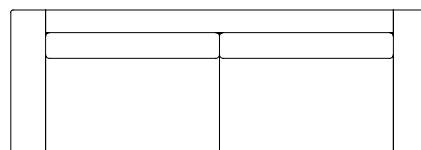

Configurações com 2 assentos e 2 braços

Módulo 186 - 2ass(70) + 2br(23) + 2alm/enc(70x48)
Módulo 216 - 2ass(85) + 2br(23) + 2alm/enc(85x48)
Módulo 246 - 2ass(100) + 2br(23) + 2alm/enc(100x48)
Módulo 276 - 2ass(115) + 2br(23) + 2alm/enc(115x48)

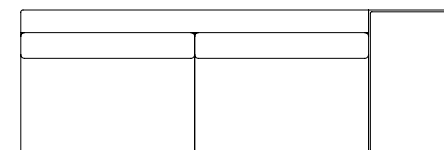

Configurações com 2 assentos e 1 mesa

Módulo 200 - 2ass(70) + 1mesa(60) + 2alm/enc(70x48)
Módulo 230 - 2ass(85) + 1mesa(60) + 2alm/enc(85x48)
Módulo 260 - 2ass(100) + 1mesa(60) + 2alm/enc(100x48)
Módulo 290 - 2ass(115) + 1mesa(60) + 2alm/enc(115x48)

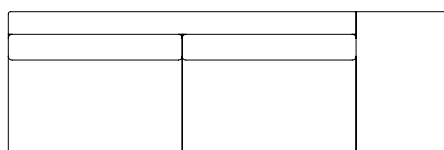

Configurações com 2 assentos e 1 puff

Módulo 200 - 2ass(70) + 1puff(60) + 2alm/enc(70x48)
Módulo 230 - 2ass(85) + 1puff(60) + 2alm/enc(85x48)
Módulo 260 - 2ass(100) + 1puff(60) + 2alm/enc(100x48)
Módulo 290 - 2ass(115) + 1puff(60) + 2alm/enc(115x48)

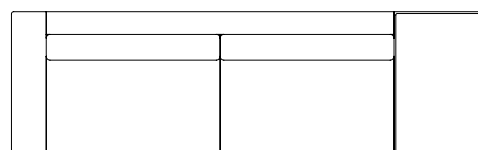

Configurações com 2 assentos, 1 braço e 1 mesa

Módulo 223 - 2ass(70) + 1br(23) + 1mesa(60) + 2alm/enc(70x48)
Módulo 253 - 2ass(85) + 1br(23) + 1mesa(60) + 2alm/enc(85x48)
Módulo 283 - 2ass(100) + 1br(23) + 1mesa(60) + 2alm/enc(100x48)
Módulo 313 - 2ass(115) + 1br(23) + 1mesa(60) + 2alm/enc(115x48)

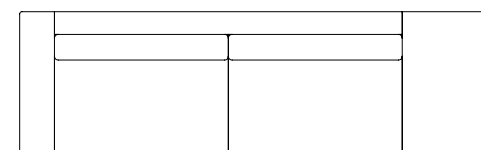

Configurações com 2 assentos, 1 braço e 1 puff

Módulo 223 - 2ass(70) + 1br(23) + 1puff(60) + 2alm/enc(70x48)
Módulo 253 - 2ass(85) + 1br(23) + 1puff(60) + 2alm/enc(85x48)
Módulo 283 - 2ass(100) + 1br(23) + 1puff(60) + 2alm/enc(100x48)
Módulo 313 - 2ass(115) + 1br(23) + 1puff(60) + 2alm/enc(115x48)

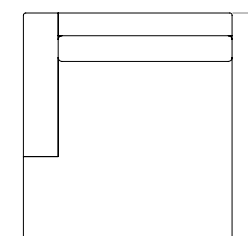

Configurações de Chaise

Chaise 123 - 1ass(100) + 1br(23) + 1alm/enc(100x48)
Chaise 138 - 1ass(115) + 1br(23) + 1alm/enc(115x48)



Configurações de puff

Puff 70 - 1puff(70x78)
Puff 85 - 1puff(85x78)
Puff 100 - 1puff(100x78)
Puff 115 - 1puff(115x78)
Puff canto 95 - 1puff(95x95)

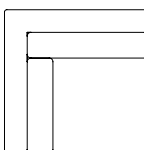

Configuração de canto

Canto 95 - 1ass(72) + 1br/enc(23) + 1alm/enc(85x48) + 1alm/enc(65x48)

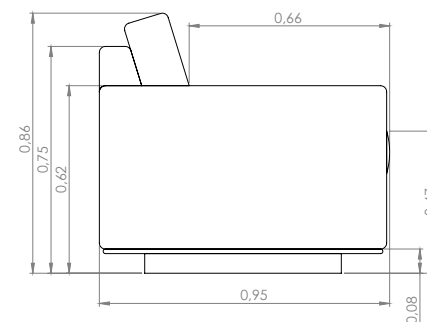

NUAGE

Design PEDRO MENDES



DESCRIÇÃO DO PRODUTO

ASSENTO: FIXO - PERCINTA + D33 + HR + D26 ULTRACEL + FIBRA.

ENCOSTO: FIXO - D20 SOFT + D23 HIPER + FIBRA.

ALMOFADA DE ENCOSTO: SOLTA - D23 HIPER + D26 ULTRACEL + ALGODÃO + FIBRA.

ALMOFADA DECORATIVA: SOLTA - D26 ULTRACEL + ALGODÃO + FIBRA.

ALMOFADA DE BRAÇO: SOLTA - FIBRA SILICONADA.

BASE: PINTURA ELETROSTÁTICA - CHUMBO, MARRON OU BLACK.

GAVETÃO: TINGIMENTO - NATURAL, EBANIZADO, LINEN, NOGUEIRA, NOZES OU IMBUIA.

PINTURA LACA - PRETO, BRANCO, NUDE OU FENDI.

DETALHE BRAÇO: TINGIMENTO - NATURAL, EBANIZADO, LINEN, NOGUEIRA, NOZES OU IMBUIA.

PINTURA LACA - PRETO, BRANCO, NUDE OU FENDI.

DETALHE COSTURA: COSTURA G

LINHA DETALHE COSTURA: BRANCO (01), VERDE (02), CAMELO (03), MARRON (04), PRETO (05), AREIA (06) OU CINZA (07).

OBSERVAÇÕES: AS ALMOFADAS DE RIM POSSUEM A MEDIDA 9CM MENOR QUE A ALMOFADA DE ENCOSTO. A CONFIGURAÇÃO DE POLTRONA NÃO POSSUI ALMOFADA BRAÇO.

OPCIONAIS: ALMOFADA GRANDE (TAMANHO DO ASSENTO) OU ALMOFADA MÉDIA (10CM MAIOR QUE A ALMOFADA PADRÃO).

DESCRIPTION OF PRODUCT

SEAT: FIXED - ELASTIC BELT + D33 + HR + D26 ULTRACEL + FIBER.

BACKREST: FIXED - D20 SOFT + D23 HYPER + FIBER.

BACKREST CUSHION: LOOSE - D23 HYPER + D26 ULTRACEL + COTTON + FIBER.

DECORATIVE CUSHION: LOOSE - D26 ULTRACEL + COTTON + FIBER.

ARM CUSHION: LOOSE - SILICONIZED FIBER.

BASE: ELECTROSTATIC PAINTING - LEAD, BROWN OR BLACK.

INVOLVING STRUCTURE: DYEING - NATURAL, EBANIZED, LINEN, WALNUT OR IMBUIA.

LACQUER PAINTING - BLACK, WHITE, NUDE OR FENDI.

ARM DETAIL: DYEING - NATURAL, EBONY,

LINEN, WALNUT, WALNUT OR IMBUIA.

LACQUER PAINTING - BLACK, WHITE, NUDE OR FENDI.

SEWING DETAIL: SEWING G.

SEWING THREAD: WHITE (01), GREEN (02), CAMEL (03), BROWN (04), BLACK (05), SAND (06) OR GRAY (07).

NOTES: THE DECORATIVE CUSHIONS HAVE THE MEASURE 9CM SMALLER THAN THE BACKREST CUSHION.

THE ARMCHAIR CONFIGURATION DOES NOT HAVE ARM CUSHION.

OPTIONAL: LARGE CUSHION (SEAT SIZE) OR MEDIUM CUSHION (10CM LARGER THAN THE STANDARD CUSHION).

DESCRIPCIÓN DEL PRODUCTO

ASIENTO: FIJO - CINTURÓN ELÁSTICO + D33 + HR + D26 ULTRACEL + FIBRA.

RESPALDO: FIJO - D20 SUAVE + D23 HIPER + FIBRA.

ALMOHADA DE RESPALDO: SUELTO - D23 HIPER + D26 ULTRACEL + ALGODÓN + FIBRA.

ALMOHADA DECORATIVA: SUELTA - D26 ULTRACEL + ALGODÓN + FIBRA.

ALMOHADA DE BRAZO: SUELTO - FIBRA DE SILICONA.

BASE: PINTURA ELECTROSTÁTICA - PLOMO, MARRÓN O NEGRO.

CAJÓN: TINTE - NATURAL, EBANIZADO, LINO, NOGAL, NUEZ O IMBUIA. ACABADO DE LACA - NEGRO, BLANCO, NUDE O FENDI.

DETALLE DEL BRAZO: TINTE - NATURAL, ÉBANO, LINO, NOGAL O IMBUIA.

PINTURA DE LACA - NEGRA, BLANCA, NUDE O FENDI.

DETALLE DE LA COSTURA: COSTURA G.

HILO DETALLE DE LA COSTURA: BLANCO (01), VERDE (02), CAMELO (03), MARRÓN (04), NEGRO (05), ARENA (06) O GRIS (07).

OBSERVACIONES: LAS ALMOHADAS DECORATIVAS TIENEN LA MEDIDA 9CM MÁS PEQUEÑA QUE LA ALMOHADA DE RESPALDO.

LA CONFIGURACIÓN DEL SILLÓN NO TIENE ALMOHADA DE BRAZO.

OPCIONAL: ALMOHADA GRANDE (TAMAÑO DEL ASIENTO) O ALMOHADA MEDIANA (10 CM MÁS GRANDE QUE LA ALMOHADA ESTÁNDAR).

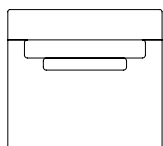

Configurações com 1 assento e sem braço

Módulo 75 - 1ass(75) + 1alm/enc(42x47) + 1alm/rim(32x37)
Módulo 90 - 1ass(90) + 1alm/enc(52x47) + 1alm/rim(42x37)
Módulo 105 - 1ass(105) + 1alm/enc(62x47) + 1alm/rim(52x37)
Módulo 120 - 1ass(120) + 1alm/enc(72x47) + 1alm/rim(62x37)

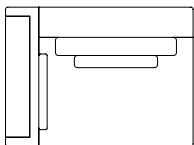

Configurações com 1 assento e 1 braço

Módulo 97 - 1ass(75) + 1br(22) + 1alm/enc(42x47) + 1alm/rim(32x37) + 1alm/br(56x25)
Módulo 112 - 1ass(90) + 1br(22) + 1alm/enc(52x47) + 1alm/rim(42x37) + 1alm/br(56x25)
Módulo 127 - 1ass(105) + 1br(22) + 1alm/enc(62x47) + 1alm/rim(52x37) + 1alm/br(56x25)
Módulo 142 - 1ass(120) + 1br(22) + 1alm/enc(72x49) + 1alm/rim(62x37) + 1alm/br(56x25)

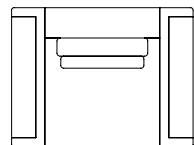

Configuração de Poltrona

Poltrona 119 - 1ass(75) + 2br(22) + 1alm/enc(42x47) + 1alm/rim(32x37)

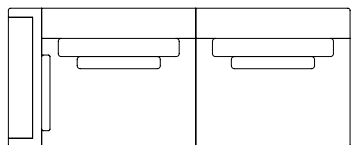

Configurações com 2 assentos e 1 braço

Módulo 172 - 2ass(75) + 1br(22) + 2alm/enc(42x47) + 2alm/rim(32x37) + 1alm/br(56x25)
Módulo 202 - 2ass(90) + 1br(22) + 2alm/enc(52x47) + 2alm/rim(42x37) + 1alm/br(56x25)
Módulo 232 - 2ass(105) + 1br(22) + 2alm/enc(62x47) + 2alm/rim(52x37) + 1alm/br(56x25)
Módulo 262 - 2ass(120) + 1br(22) + 2alm/enc(72x47) + 2alm/rim(62x37) + 1alm/br(56x25)

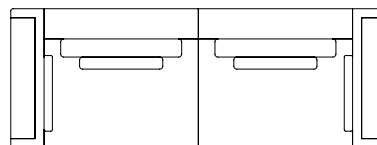

Configurações com 2 assentos e 2 braços

Módulo 194 - 2ass(75) + 2br(22) + 2alm/enc(42x47) + 2alm/rim(32x37) + 2alm/br(56x25)
Módulo 224 - 2ass(90) + 2br(22) + 2alm/enc(52x47) + 2alm/rim(42x37) + 2alm/br(56x25)
Módulo 254 - 2ass(105) + 2br(22) + 2alm/enc(62x47) + 2alm/rim(52x37) + 2alm/br(56x25)
Módulo 284 - 2ass(120) + 2br(22) + 2alm/enc(72x47) + 2alm/rim(62x37) + 2alm/br(56x25)

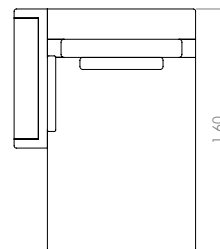

Configurações de Chaise

Chaise 127 - 1ass(105) + 1br(22) + 1alm/enc(62x47) + 1alm/rim(52x37) + 1alm/br(56x25)
Chaise 142 - 1ass(120) + 1br(22) + 1alm/enc(72x47) + 1alm/rim(62x37) + 1alm/br(56x25)

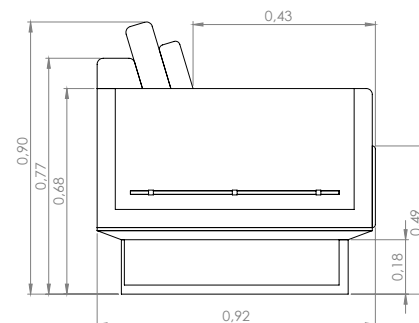

NUAGE

3 tamanhos
de almofadas





BRANDON

Design PEDRO MENDES



DESCRIÇÃO DO PRODUTO

ASSENTO: SOLTO - PERCINTA + HR + D26 ULTRACEL + FIBRA.

ENCOSTO: FIXO - D20 SOFT + D33 + FIBRA.

ALMOFADA DE ENCOSTO: SOLTA - D23 HIPER + D26 ULTRACEL + FIBRA.

ALMOFADA DE RIM: SOLTA - D26 ULTRACEL + FELTRO + FIBRA.

PÉ: IMBUÍA.

MESA: LÂMINA NATURAL - CARVALHO NATURAL, CARVALHO EBANIZADO, CARVALHO LINEN OU NOGUEIRA. PINTURA ELETROSTÁTICA - CHUMBO, MARRON OU BLACK.

OPCIONAIS: CARREGADOR USB NO BRAÇO (CABO DE ALIMENTAÇÃO PARA TOMADA PADRÃO DO BRASIL OU EUA).

DESCRIPTION OF PRODUCT

SEAT: LOOSE - ELASTIC BELT + HR + D26 ULTRACEL + FIBER.

BACKREST: FIXED - D20 SOFT + D33 + FIBER.

BACKREST CUSHION: LOOSE - D23 HYPER + D26 ULTRACEL + FIBER.

LUMBAR CUSHION: LOOSE - D26 ULTRACEL + FELT + FIBER.

FOOT: IMBUÍA.

TABLE: NATURAL VENEER - NATURAL OAK, EBANIZED OAK, OAK LINEN OR WALNUT. ELECTROSTATIC PAINT - LEAD, BROWN OR BLACK

OPTIONAL: USB CHARGER ON THE ARMREST (POWER CORD TO STANDARD BRAZIL OR US OUTLET).

DESCRIPCIÓN DEL PRODUCTO

ASIENTO: SUELTO - CINCHA + HR + D26 ULTRACEL + FIBRA.

RESPALDO: FIJO - D20 BLANDO + D33 + FIBRA.

ALMOHADA DE RESPALDO: SUELTO - D23 HIPER + D26 ULTRACEL + FIBRA.

ALMOHADA ESPALDA BAJA: SUELTO - D26 ULTRACEL + FIELTRO + FIBRA.

PIE: IMBUÍA.

MESA: CHAPA NATURAL - ROBLE NATURAL, ROBLE EBANIZADO, ROBLE LINO O NOGAL. PINTURA ELECTROSTÁTICA - PLOMO, MARRÓN O NEGRO.

OPCIONAL: CARGADOR USB EN EL BRAZO (CABLE DE ALIMENTACIÓN A ENCHUFE ESTÁNDAR EN BRASIL O EE. UU.).

BRANDON

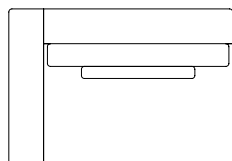

Configurações com 1 assento e 1 braço

Módulo 98 - 1ass(75) + 1br(23) + 1alm/enc(65x48) + 1alm/rim(58x38)
Módulo 123 - 1ass(100) + 1br(23) + 1alm/enc(90x48) + 1alm/rim(61x38)
Módulo 138 - 1ass(115) + 1br(23) + 1alm/enc(105x48) + 1alm/rim(66x38)
Módulo 148 - 1ass(125) + 1br(23) + 1alm/enc(115x48) + 1alm/rim(76x38)
Módulo 158 - 1ass(135) + 1br(23) + 1alm/enc(125x48) + 1alm/rim(86x38)

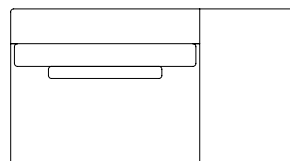

Configurações com 1 assentos e 1 mesa

Módulo 136 - 1ass(75) + 1mesa(61) + 1alm/enc(65x48) + 1alm/rim(58x38)
Módulo 161 - 1ass(100) + 1mesa(61) + 1alm/enc(90x48) + 1alm/rim(61x38)
Módulo 176 - 1ass(115) + 1mesa(61) + 1alm/enc(105x48) + 1alm/rim(66x38)
Módulo 186 - 1ass(125) + 1mesa(61) + 1alm/enc(115x48) + 1alm/rim(76x38)
Módulo 196 - 1ass(135) + 1mesa(61) + 1alm/enc(125x48) + 1alm/rim(86x38)

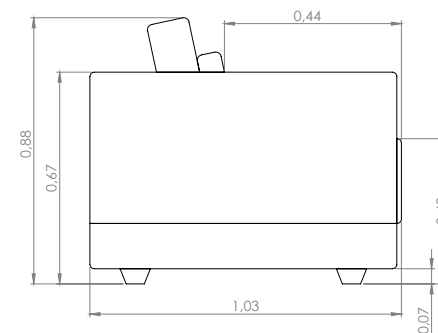

SPLENDIDO

Design STUDIO FEELING



DESCRIÇÃO DO PRODUTO

ASSENTO: FIXO - MOLA + PERCINTA + D33 + D26 ULTRACEL + HR + FIBRA.

ENCOSTO: FIXO - D23 HIPER + D20 SOFT + FIBRA.

ALMOFADA DE ENCOSTO: SOLTA - D23 HIPER + D26 ULTRACEL + FIBRA.

PÉS: PINTURA ELETROSTÁTICA - CHUMBO, MARROM OU BLACK.

POLIDO - ALUMÍNIO.

BASE: LÂMINA NATURAL - CARVALHO NATURAL, CARVALHO EBANIZADO, CARVALHO LINEN OU NOGUEIRA.

OPCIONAIS: CARREGADOR USB NO BRAÇO (CABO DE ALIMENTAÇÃO PARA TOMADA PADRÃO DO BRASIL OU EUA).

OBSERVAÇÕES: NAS CONFIGURAÇÕES DE CHAISE HAVERÁ UMA COSTURA ADICIONAL NO ASSENTO DEVIDO A LARGURA DO TECIDO

DESCRIPTION OF PRODUCT

SEAT: FIXED - SPRING + ELASTIC BELT + D33 + D26 ULTRACEL + HR + FIBER.

BACKREST: FIXED - D23 HYPER + D20 SOFT + FIBER.

BACKREST CUSHION: LOOSE - D23 HYPER + D26 ULTRACEL + FIBER.

FOOT: ELECTROSTATIC PAINTING - LEAD, BROWN OR BLACK.

POLISHED - ALUMINUM.

BASE: NATURAL VENEER - NATURAL OAK, EBANIZED OAK, OAK LINEN OR WALNUT.

OPTIONAL: USB CHARGER ON THE ARMREST (POWER CORD TO STANDARD BRAZIL OR US OUTLET).

NOTES: ON CHAISE CONFIGURATIONS THERE WILL BE AN ADDITIONAL SEWING ON THE SEAT DUE TO THE WIDTH OF THE FABRIC.

DESCRIPCIÓN DEL PRODUCTO

ASIENTO: FIJO - RESORTE + CINTURÓN ELÁSTICO + D33 + D26 ULTRACEL + HR + FIBRA.

RESPALDO: FIJO - D23 HIPER + D20 SOFT + FIBRA.

ALMOHADA DE RESPALDO: SUELTO - D23 HIPER + D26 ULTRACEL + FIBRA.

PIES: PINTURA ELECTROSTÁTICA - PLOMO, MARRÓN O NEGRO.

PULIDO - ALUMINIO.

BASE: CHAPA NATURAL - ROBLE NATURAL, ROBLE EBANIZADO, ROBLE LINO O NOGAL.

OPCIONAL: CARGADOR USB EN EL BRAZO (CABLE DE ALIMENTACIÓN A ENCHUFE ESTÁNDAR EN BRASIL O EE. UU.).

OBSERVACIONES: EN LAS CONFIGURACIONES DE CHAISE, HABRÁ UNA COSTURA ADICIONAL EN EL ASIENTO POR A LA ANCHURA DE LA TELA.

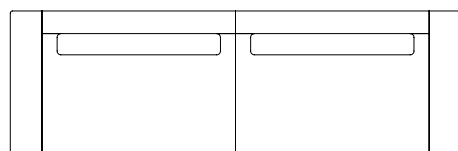

Configurações com 2 assentos e 2 braços encostos

Módulo 212 - 2ass(85) + 2br/enc(21) + 2alm/enc(64x45)
Módulo 244 - 2ass(101) + 2br/enc(21) + 2alm/enc(80x45)
Módulo 298 - 2ass(128) + 2br/enc(21) + 2alm/enc(108x45)

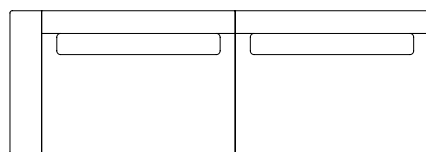

Configurações com 2 assentos e 1 braço encosto

Módulo 191 - 2ass(85) + 1br/enc(21) + 2alm/enc(64x45)
Módulo 223 - 2ass(101) + 1br/enc(21) + 2alm/enc(80x45)
Módulo 277 - 2ass(128) + 1br/enc(21) + 2alm/enc(108x45)

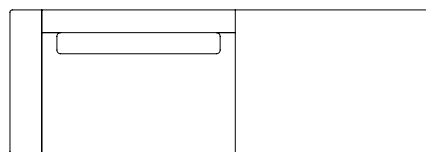

Configurações com 1 assento, 1 braço encosto e 1 puff

Módulo 191 - 1ass(85) + 1br/enc(21) + 1puff(85) + 1alm/enc(64x45)
Módulo 223 - 1ass(101) + 1br/enc(21) + 1puff(101) + 1alm/enc(80x45)
Módulo 277 - 1ass(128) + 1br/enc(21) + 1puff(128) + 1alm/enc(108x45)

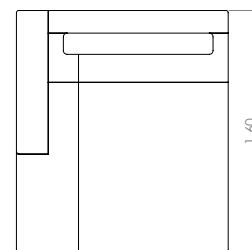

Configurações de Chaise

Chaise 120 - 1ass(99) + 1br(21) + 1alm/enc(78x45)
Chaise 140 - 1ass(119) + 1br(21) + 1alm/enc(96x45)

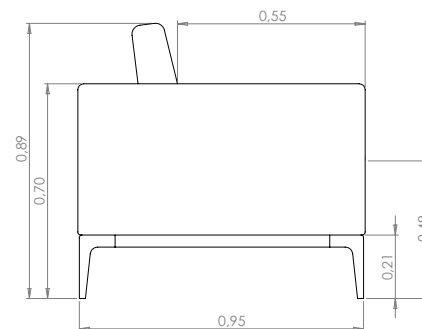

CARIBE

Design SÉRGIO BATISTA



DESCRIÇÃO DO PRODUTO

ASSENTO: FIXO - MOLA + HR + D26 ULTRACEL + D20 SOFT + FIBRA.

ENCOSTO: FIXO - D20 SOFT + FIBRA.

ALMOFADA DE ENCOSTO: SOLTA - FIBRA SILICONADA.

PÉ: IMBUÍA.

OBSERVAÇÃO: PRODUTO INDISPONÍVEL EM COURO.

DESCRIPTION OF PRODUCT

SEAT: FIXED - SPRING + HR + D26 ULTRACEL + D20 SOFT + FIBER.

BACKREST: FIXED - D20 SOFT + FIBER.

BACKREST CUSHION: LOOSE - SILICON FIBER

FOOT: IMBUÍA

NOTE: PRODUCT NOT AVAILABLE IN LEATHER

DESCRIPCIÓN DEL PRODUCTO

ASIENTO: FIJO - RESORTE + HR + D26 ULTRACEL + D20 SUAVE + FIBRA.

RESPALDO: FIJO - HR + D20 SUAVE + FIBRA.

ALMOHADA DEL RESPALDO: SUELTO - FIBRA SILICONADA

PIES: IMBUÍA

OBSERVACIONES: PRODUCTO NO DISPONIBLE EN PIEL

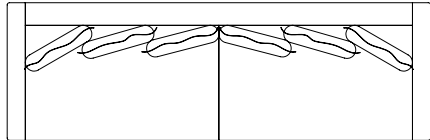

Configurações com 2 assentos e 2 braços

Módulo 214 - 2ass(95) + 2br(12) + 5alm/enc(50x50)

Módulo 244 - 2ass(110) + 2br(12) + 6alm/enc(50x50)

Módulo 280 - 2ass(128) + 2br(12) + 8alm/enc(50x50)

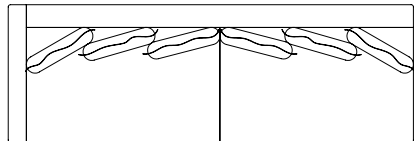

Configurações com 2 assentos e 1 braço

Módulo 202 - 2ass(95) + 1br(12) + 5alm/enc(50x50)

Módulo 232 - 2ass(110) + 1br(12) + 6alm/enc(50x50)

Módulo 268 - 2ass(128) + 1br(12) + 8alm/enc(50x50)

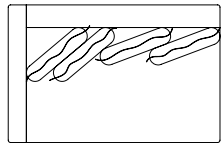

Configurações com 1 assento e 1 braço

Módulo 107 - 1ass(95) + 1br(12) + 2alm/enc(50x50)

Módulo 122 - 1ass(110) + 1br(12) + 3alm/enc(50x50)

Módulo 140 - 1ass(128) + 1br(12) + 4alm/enc(50x50)

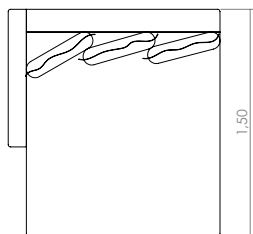

Configurações de Chaise

Chaise 110 - 1ass(98) + 1br(12) + 2alm/enc(50x50)

Chaise 135 - 1ass(123) + 1br(12) + 3alm/enc(50x50)

CARIBE

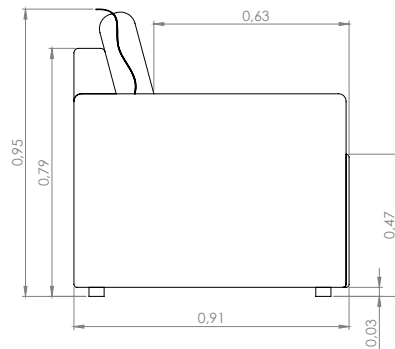

Configuração de Almofada

Alm/enc(50x50)



ASTER

Design STUDIO FEELING



DESCRIÇÃO DO PRODUTO

ASSENTO: FIXO - HR + D26 ULTRACEL + FIBRA.

ENCOSTO: FIXO - D20 SOFT + D33.

ALMOFADA DE ENCOSTO: SOLTA - D23 HIPER + D26 ULTRACEL + FIBRA.

ALMOFADA DE RIM: SOLTA - D23 HIPER + D26 ULTRACEL + FIBRA.

ROLINHO ENCOSTO: FIXO - D33 + FIBRA.

ROLINHO BRAÇO: FIXO - D33 + FIBRA.

BASE: PINTURA ELETROSTÁTICA - CHUMBO, MARROM OU BLACK.

ALÇA BRAÇO: PINTURA ELETROSTÁTICA - CHUMBO, MARROM OU BLACK.

OS TAMANHOS DAS ALMOFADAS DA IMAGEM NÃO CORRESPONDEM ÀS MEDIDAS PADRÕES DO PRODUTO. AS DIMENSÕES REAIS PODEM SER VERIFICADAS NA LISTA DE CONFIGURAÇÕES.

DESCRIPTION OF PRODUCT

SEAT: FIXED - HR + D26 ULTRACEL + FIBER.

BACKREST: FIXED - D20 SOFT + D33.

BACKREST CUSHION: LOOSE - D23 HYPER + D26 ULTRACEL + FIBER.

LUMBAR CUSHION: LOOSE - D23 HYPER + D26 ULTRACEL + FIBER.

BACKREST CUSHION: FIXED - D33 + FIBER.

ARMREST: FIXED - D33 + FIBER.

BASE: ELECTROSTATIC PAINTING - LEAD, BROWN OR BLACK.

ARM HANDLE: ELECTROSTATIC PAINTING - LEAD, BROWN OR BLACK.

THE SIZES OF THE PILLOWS IN THE IMAGE DO NOT CORRESPOND TO THE STANDARD MEASUREMENTS OF THE PRODUCT. ACTUAL DIMENSIONS CAN BE CHECKED IN THE CONFIGURATION LIST.

DESCRIPCIÓN DEL PRODUCTO

ASIENTO: FIJO - HR + D26 ULTRACEL + FIBRA.

RESPALDO: FIJO - D20 SUAVE + D33.

ALMOHADA DE RESPALDO: SUELTO - D23 HIPER + D26 ULTRACEL + FIBRA.

ALMOHADA ESPALDA BAJA: SUELTO - D23 HIPER + D26 ULTRACEL + FIBRA.

ALMOHADA DE RESPALDO: FIJO - D33 + FIBRA.

BRAZOS: FIJO - D33 + FIBRA.

BASE: PINTURA ELECTROSTÁTICA - PLOMO, MARRÓN O NEGRO.

MANIJA DEL BRAZO: PINTURA ELECTROSTÁTICA - PLOMO, MARRÓN O NEGRO.

LOS TAMAÑOS DE LAS ALMOHADAS DE LA IMAGEN NO SE CORRESPONDEN CON LAS MEDIDAS ESTÁNDAR DEL PRODUCTO. LAS DIMENSIONES REALES SE PUEDEN COMPROBAR EN LA LISTA DE CONFIGURACIÓN.



ASTER

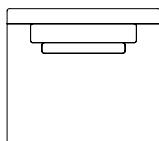

Configurações com 1 assento e sem braço

Módulo 85 - 1ass(85) + 1alm/enc(64x41) + 1alm/dec(53x32)
 Módulo 101 - 1ass(101) + 1alm/enc(79x41) + 1alm/dec(69x32)
 Módulo 121 - 1ass(121) + 1alm/enc(99x41) + 1alm/dec(89x32)
 Módulo 141 - 1ass(141) + 1alm/enc(119x41) + 1alm/dec(109x32)

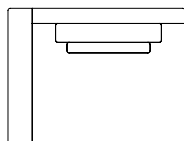

Configurações com 1 assento e 1 braço

Módulo 101 - 1ass(85) + 1br(16) + 1alm/enc(64x41) + 1alm/dec(53x32)
 Módulo 118 - 1ass(101) + 1br(16) + 1alm/enc(79x41) + 1alm/dec(69x32)
 Módulo 137 - 1ass(121) + 1br(16) + 1alm/enc(99x41) + 1alm/dec(89x32)
 Módulo 157 - 1ass(141) + 1br(16) + 1alm/enc(119x41) + 1alm/dec(109x32)

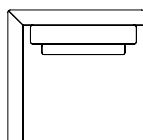

Configuração de canto

Canto 90 - 1ass(74) + 1br/enc(16) + 1alm/enc(55x41) + 1alm/dec(45x32)

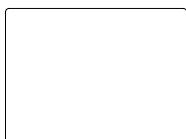

Configurações de Puff

Puff 85 - 1puff(85x90)
 Puff 101 - 1puff(101x62)
 Puff 101 - 1puff(101x90)
 Puff 121 - 1puff(121x62)
 Puff 141 - 1puff(141x62)
 Puff canto 90 - 1puff(90x90)

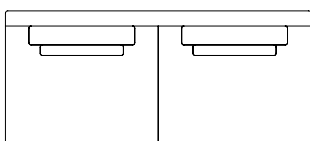

Configurações com 2 assentos e sem braço

Módulo 170 - 2ass(85) + 2alm/enc(64x41) + 2alm/dec(53x32)
 Módulo 202 - 2ass(101) + 2alm/enc(79x41) + 2alm/dec(69x32)
 Módulo 242 - 2ass(121) + 2alm/enc(99x41) + 2alm/dec(89x32)
 Módulo 282 - 2ass(141) + 2alm/enc(119x41) + 2alm/dec(109x32)

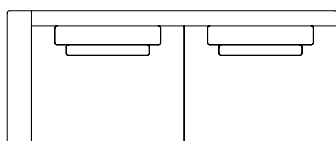

Configurações com 2 assentos e 1 braço

Módulo 186 - 2ass(85) + 1br(16) + 2alm/enc(64x41) + 2alm/dec(53x32)
 Módulo 218 - 2ass(101) + 1br(16) + 2alm/enc(79x41) + 2alm/dec(69x32)
 Módulo 258 - 2ass(121) + 1br(16) + 2alm/enc(99x41) + 2alm/dec(89x32)
 Módulo 298 - 2ass(141) + 1br(16) + 2alm/enc(119x41) + 2alm/dec(109x32)

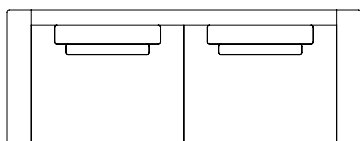

Configurações com 2 assentos e 2 braços

Módulo 202 - 2ass(85) + 2br(16) + 2alm/enc(64x41) + 2alm/dec(53x32)
 Módulo 234 - 2ass(101) + 2br(16) + 2alm/enc(79x41) + 2alm/dec(69x32)
 Módulo 274 - 2ass(121) + 2br(16) + 2alm/enc(99x41) + 2alm/dec(89x32)
 Módulo 314 - 2ass(141) + 2br(16) + 2alm/enc(119x41) + 2alm/dec(109x32)

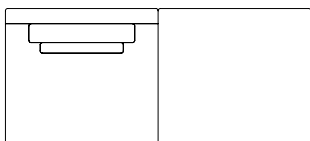

Configurações com 1 assento e 1 puff

Módulo 170 - 1ass(85) + 1puff(85) + 1alm/enc(64x41) + 1alm/dec(53x32)
 Módulo 202 - 1ass(101) + 1puff(101) + 1alm/enc(79x41) + 1alm/dec(69x32)
 Módulo 242 - 1ass(121) + 1puff(121) + 1alm/enc(99x41) + 1alm/dec(89x32)
 Módulo 282 - 1ass(141) + 1puff(141) + 1alm/enc(119x41) + 1alm/dec(109x32)

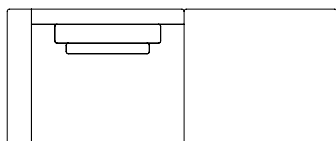

Configurações com 1 assento, 1 braço e 1 puff

Módulo 186 - 1ass(85) + 1br(16) + 1puff(85) + 1alm/enc(64x41) + 1alm/dec(53x32)
 Módulo 218 - 1ass(101) + 1br(16) + 1puff(101) + 1alm/enc(79x41) + 1alm/dec(69x32)
 Módulo 258 - 1ass(121) + 1br(16) + 1puff(121) + 1alm/enc(99x41) + 1alm/dec(89x32)
 Módulo 298 - 1ass(141) + 1br(16) + 1puff(141) + 1alm/enc(119x41) + 1alm/dec(109x32)

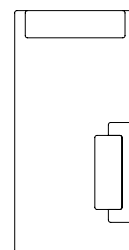

Configurações de Puff Chaise

Chaise 160 - 1ass(160) + 1rol/br(18x65) + 1rol/enc(77x18) + 1alm/dec(65x32)
 Chaise 180 - 1ass(180) + 1rol/br(18x65) + 1rol/enc(87x18) + 1alm/dec(75x32)
 Chaise 200 - 1ass(200) + 1rol/br(18x65) + 1rol/enc(97x18) + 1alm/dec(85x32)

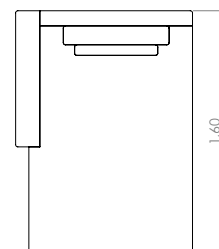

Configurações de Chaise

Chaise 120 - 1ass(104) + 1br(16) + alm/enc(98x41) + 1alm/dec(88x32)
 Chaise 140 - 1ass(124) + 1br(16) + alm/enc(118x41) + 1alm/dec(108x32)

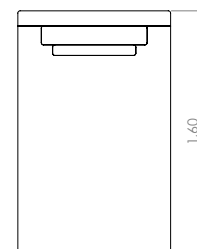

Configurações de Chaise sem braço

Chaise 120 - 1ass(120) + alm/enc(98x41) + 1alm/dec(88x32)
 Chaise 140 - 1ass(140) + alm/enc(118x41) + 1alm/dec(108x32)



Configurações de Rolinho Encosto

Rolinho encosto 71 - 1rol/enc(71) + 1alm/enc(65x32)
 Rolinho encosto 87 - 1rol/enc(87) + 1alm/enc(81x32)
 Rolinho encosto 107 - 1rol/enc(107) + 1alm/enc(101x32)
 Rolinho encosto 127 - 1rol/enc(127) + 1alm/enc(121x32)



Configuração de Rolinho Braço

Rolinho braço 18 - 1rol/br(18x65)

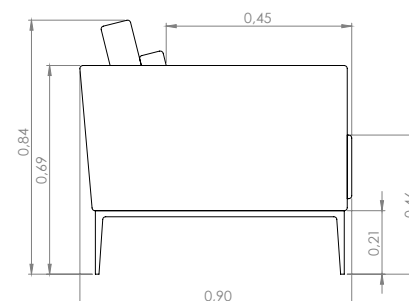



MILOS

Design STUDIO FEELING



DESCRIÇÃO DO PRODUTO

ASSENTO: FIXO - PERCINTA + D26 ULTRACEL + HR + FIBRA.

ENCOSTO: FIXO - D20 SOFT + D33 + FIBRA.

ALMOFADA DE ENCOSTO: SOLTA - D23 HIPER + D26 ULTRACEL + FIBRA.

PÉ: PINTURA ELETROSTÁTICA - CHUMBO, MARROM OU BLACK. POLIDO - ALUMÍNIO.

PONTEIRA: PINTURA ELETROSTÁTICA - CHUMBO, MARROM OU BLACK. POLIDO - ALUMÍNIO.

LINHA COSTURA: BRANCO (01), VERDE (02), CAMELO (03), MARROM (04), PRETO (05), AREIA (06) OU CINZA (07).

OPCIONAIS: CARREGADOR USB NO BRAÇO (CABO DE ALIMENTAÇÃO PARA TOMADA PADRÃO DO BRASIL OU EUA).

DESCRIPTION OF PRODUCT

SEAT: FIXED - ELASTIC BELT + D26 ULTRACEL + HR + FIBER.

BACKREST: FIXED - D20 SOFT + D33 + FIBER.

BACKREST CUSHION: LOOSE - D23 HYPER + D26 ULTRACEL + FIBER.

FOOT: ELECTROSTATIC PAINTING - LEAD, BROWN OR BLACK. POLISHED - ALUMINUM.

TIPS: ELECTROSTATIC PAINT - LEAD, BROWN OR BLACK. POLISHED - ALUMINUM.

SEWING THREAD: WHITE (01), GREEN (02), CAMEL (03), BROWN (04), BLACK (05), SAND (06) OR GRAY (07).

OPTIONAL: USB CHARGER IN THE ARMREST (POWER CORD TO STANDARD BRAZIL OR US OUTLET).

DESCRIPCIÓN DEL PRODUCTO

ASIENTO: FIJO - CINTURÓN ELÁSTICO + D26 ULTRACEL + HR + FIBRA.

RESPALDO: FIJO - D20 BLANDO + D33 + FIBRA.

ALMOHADA DE RESPALDO: SUELTO - D23 HIPER + D26 ULTRACEL + FIBRA.

PIE: PINTURA ELECTROSTÁTICA - PLOMO, MARRÓN O NEGRO. PULIDO - ALUMINIO.

REMATES: PINTURA ELECTROSTÁTICA - PLOMO, MARRÓN O NEGRO. PULIDO - ALUMINIO.

LÍNEA DE COSTURA: BLANCO (01), VERDE (02), CAMELO (03), MARRÓN (04), NEGRO (05), ARENA (06) O GRIS (07).

OPCIONAL: CARGADOR USB EN EL BRAZO (CABLE DE ALIMENTACIÓN A ENCHUFE ESTÁNDAR EN BRASIL O EE. UU.).

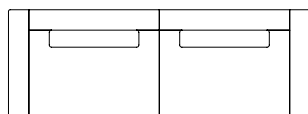

Configurações com 2 assentos e 2 braços

Módulo 228 - 2ass(96) + 2br(18) + 2alm/enc(81x45)
Módulo 266 - 2ass(115) + 2br(18) + 2alm/enc(100x45)
Módulo 282 - 2ass(123) + 2br(18) + 2alm/enc(108x45)

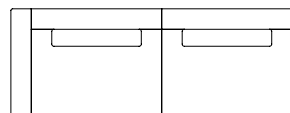

Configurações com 2 assentos e 1 braço

Módulo 194 - 2ass(88) + 1br(18) + 2alm/enc(73x45)
Módulo 210 - 2ass(96) + 1br(18) + 2alm/enc(81x45)
Módulo 248 - 2ass(115) + 1br(18) + 2alm/enc(100x45)

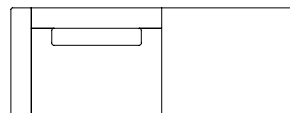

Configurações com 1 assento, 1 braço e 1 puff

Módulo 194 - 1ass(88) + 1puff(88) + 1br(18) + 1alm/enc(73x45)
Módulo 210 - 1ass(96) + 1puff(96) + 1br(18) + 1alm/enc(81x45)
Módulo 248 - 1ass(115) + 1puff(115) + 1br(18) + 1alm/enc(100x45)

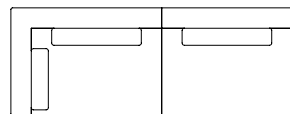

Configurações de canto com 2 assentos

Canto 204 - 2ass(91) + 1br/enc(22) + 2alm/enc(76x45) + 1alm/enc(55x45)
Canto 220 - 2ass(99) + 1br/enc(22) + 2alm/enc(84x45) + 1alm/enc(55x45)
Canto 258 - 2ass(118) + 1br/enc(22) + 2alm/enc(103x45) + 1alm/enc(55x45)

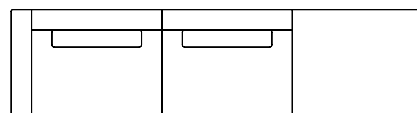

Configurações com 2 assentos, 1 braço e 1 puff

Módulo 282 - 2ass(88) + 1puff(88) + 1br(18) + 2alm/enc(73x45)
Módulo 306 - 2ass(96) + 1puff(96) + 1br(18) + 2alm/enc(81x45)

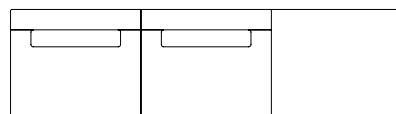

Configurações com 2 assentos e 1 puff

Módulo 264 - 2ass(88) + 1puff(88) + 2alm/enc(73x45)
Módulo 288 - 2ass(96) + 1puff(96) + 2alm/enc(81x45)

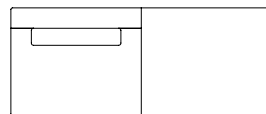

Configurações com 1 assento e 1 puff

Módulo 176 - 1ass(88) + 1puff(88) + 1alm/enc(73x45)
Módulo 192 - 1ass(96) + 1puff(96) + 1alm/enc(81x45)

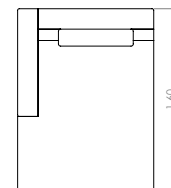

Configurações de Chaise

Chaise 120 - 1ass(102) + 1br(18) + 1alm/enc(87x45)
Chaise 140 - 1ass(122) + 1br(18) + 1alm/enc(107x45)

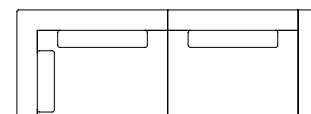

Configurações de canto com 2 assentos e 1 braço

Canto 238 - 2ass(99) + 1br/enc(22) + 1br(18) + 2alm/enc(84x45) + 1alm/enc(55x45)
Canto 276 - 2ass(118) + 1br/enc(22) + 1br(18) + 2alm/enc(103x45) + 1alm/enc(55x45)
Canto 292 - 2ass(126) + 1br/enc(22) + 1br(18) + 2alm/enc(111x45) + 1alm/enc(55x45)

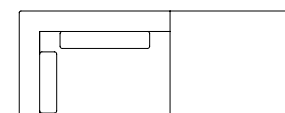

Configurações de canto com 1 assento e 1 puff

Canto 204 - 1ass(91) + 1br/enc(22) + 1puff(91) + 1alm/enc(76x45) + 1alm/enc(55x45)
Canto 220 - 1ass(99) + 1br/enc(22) + 1puff(99) + 1alm/enc(84x45) + 1alm/enc(55x45)
Canto 258 - 1ass(118) + 1br/enc(22) + 1puff(118) + 1alm/enc(103x45) + 1alm/enc(55x45)

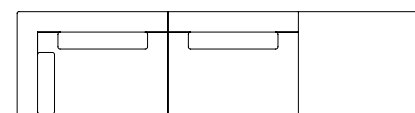

Configurações de canto com 2 assentos e 1 puff

Canto 292 - 2ass(90) + 1br/enc(22) + 1puff(90) + 2alm/enc(75x45) + 1alm/enc(55x45)
Canto 316 - 2ass(98) + 1br/enc(22) + 1puff(98) + 2alm/enc(83x45) + 1alm/enc(55x45)

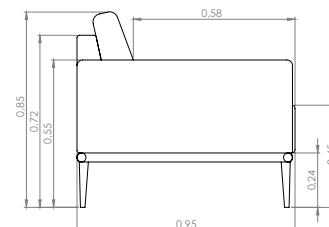

GRECO

Design PEDRO MENDES



FEELING ESTOFADOS | *Coleção Cotidiano*

DESCRIÇÃO DO PRODUTO

ASSENTO: FIXO - PERCINTA + D33 + D20 SOFT + FIBRA.

ENCOSTO: FIXO - D20 SOFT.

ALMOFADA DE ENCOSTO: SOLTA - FIBRA SILICONADA + FIBRA.

ALMOFADA DECORATIVA: SOLTA - FIBRA SILICONADA.

BASE: PINTURA ELETROSTÁTICA - CHUMBO, MARROM OU BLACK.

OPCIONAIS: CARREGADOR USB NO BRAÇO

(CABO DE ALIMENTAÇÃO PARA TOMADA PADRÃO DO BRASIL OU EUA).

OBSERVAÇÃO: PRODUTO INDISPONÍVEL EM COURO.

DESCRIPTION OF PRODUCT

SEAT: FIXED - ELASTIC BELT + D33 + D20 SOFT + FIBER.

BACKREST: FIXED - D20 SOFT.

BACKREST CUSHION: LOOSE - SILICON FIBER + FIBER.

DECORATIVE CUSHION: LOOSE - SILICON FIBER.

BASE: ELECTROSTATIC PAINTING - LEAD, BROWN OR BLACK.

OPTIONAL: USB CHARGER ON THE ARMREST (POWER CORD TO STANDARD BRAZIL OR US OUTLET).

NOTE: PRODUCT NOT AVAILABLE IN LEATHER.

DESCRIPCIÓN DEL PRODUCTO

ASIENTO: FIJO - CINTURÓN ELÁSTICO + D33 + D20 SUAVE + FIBRA.

RESPALDO: FIJO - D20 SUAVE.

ALMOHADA DE RESPALDO: SUELTO - FIBRA SILICONADA + FIBRA.

ALMOHADA DECORATIVA: SUELTO - FIBRA SILICONADA.

BASE: PINTURA ELECTROSTÁTICA - PLOMO, MARRÓN O NEGRO.

OPCIONAL: CARGADOR USB EN EL BRAZO (CABLE DE ALIMENTACIÓN A ENCHUFE ESTÁNDAR EN BRASIL O EE. UU.).

OBSERVACIONES: PRODUCTO NO DISPONIBLE EN PIEL.

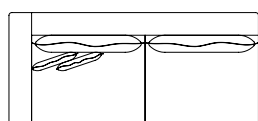

Configurações com 2 assentos e 1 braço

Módulo 180 - 2ass(80) + 1br(20) + 1alm/enc(80x52) + 2alm/dec(45x45)
Módulo 200 - 2ass(90) + 1br(20) + 1alm/enc(90x52) + 2alm/dec(45x45)
Módulo 220 - 2ass(100) + 1br(20) + 1alm/enc(100x52) + 2alm/dec(45x45)

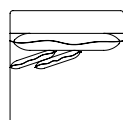

Configurações com 1 assento e sem braço

Módulo 80 - 1ass(80) + 1alm/enc(80x52) + 2alm/dec(45x45)
Módulo 90 - 1ass(90) + 1alm/enc(90x52) + 2alm/dec(45x45)
Módulo 100 - 1ass(100) + 1alm/enc(100x52) + 2alm/dec(45x45)

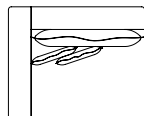

Configurações com 1 assento e 1 braço

Módulo 100 - 1ass(80) + 1br(20) + 1alm/enc(80x52) + 2alm/dec(45x45)
Módulo 110 - 1ass(90) + 1br(20) + 1alm/enc(90x52) + 2alm/dec(45x45)
Módulo 120 - 1ass(100) + 1br(20) + 1alm/enc(100x52) + 2alm/dec(45x45)



Configurações de puff

Puff 80 - 1puff(80x80)
Puff 90 - 1puff(90x80)
Puff 100 - 1puff(100x80)

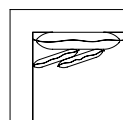

Configuração de Canto

Canto 100 - 1ass(85) + 1br/enc(15) + 1alm/enc(84x52) + 2alm/dec(45x45)

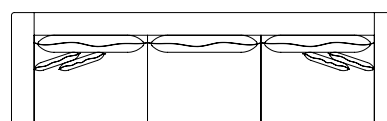

Configuração com 3 assentos e 2 braços

Módulo 310 - 3ass(90) + 2br(20) + 3alm/enc(90x52) + 4alm/dec(45x45)

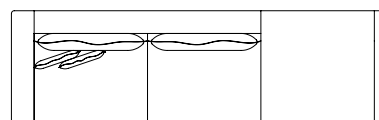

Configurações com 2 assentos, 1 puff, 1 braço e com detalhe

Módulo 270 - 2ass(80) + 1puff(80) + 1br(20) + 1det(10) + 2alm/enc(80x52) + 2alm/dec(45x45)
Módulo 300 - 2ass(90) + 1puff(90) + 1br(20) + 1det(10) + 2alm/enc(90x52) + 2alm/dec(45x45)
Módulo 330 - 2ass(100) + 1puff(100) + 1br(20) + 1det(10) + 2alm/enc(100x52) + 2alm/dec(45x45)



Configurações de puff com detalhe

Puff 90 - 1puff(80x100) + 1det(10)
Puff 100 - 1puff(90x100) + 1det(10)
Puff 110 - 1puff(100x100) + 1det(10)

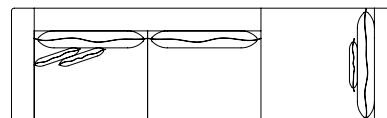

Configurações com 2 assentos, 1 puff, 1 braço e 1 encosto invertido

Módulo 275 - 2ass(80) + 1puff(80) + 1br(20) + 1enc/inv(15) + 3alm/enc(80x52) + 3alm/dec(45x45)
Módulo 305 - 2ass(90) + 1puff(90) + 1br(20) + 1enc/inv(15) + 3alm/enc(90x52) + 3alm/dec(45x45)
Módulo 335 - 2ass(100) + 1puff(100) + 1br(20) + 1enc/inv(15) + 3alm/enc(100x52) + 3alm/dec(45x45)

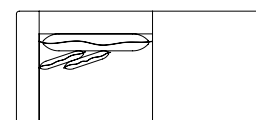

Configurações com 1 assento, 1 braço e 1 puff

Módulo 180 - 1ass(80) + 1puff(80) + 1br(20) + 1alm/enc(80x52) + 2alm/dec(45x45)
Módulo 200 - 1ass(90) + 1puff(90) + 1br(20) + 1alm/enc(90x52) + 2alm/dec(45x45)
Módulo 220 - 1ass(100) + 1puff(100) + 1br(20) + 1alm/enc(100x52) + 2alm/dec(45x45)



Configurações de Chaise

Chaise 120 - 1ass(100) + 1br(20) + 1alm/enc(100x52) + 2alm/dec(45x45)
Chaise 140 - 1ass(120) + 1br(20) + 1alm/enc(120x52) + 2alm/dec(45x45)

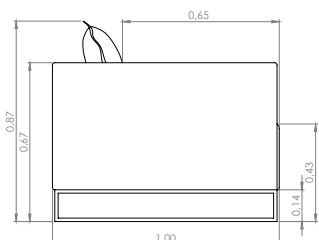

Configuração de Almofada
Alm/dec(45x45)

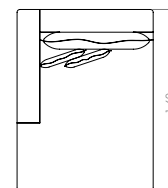

GRECO



BLEND

Design STUDIO FEELING



DESCRIÇÃO DO PRODUTO

ASSENTO: FIXO - MOLA ZIG ZAG + D33 + HR + D26 ULTRACEL + FIBRA.

ENCOSTO: FIXO - D23 HIPER + D33 + D20 SOFT + FIBRA.

ALMOFADA DE ENCOSTO: SOLTA - D23 HIPER + D26 ULTRACEL + FIBRA.

ALMOFADA DE RIM: SOLTA - D23 HIPER + D26 ULTRACEL + FIBRA.

BASE: PINTURA ELETROSTÁTICA - CHUMBO, MARROM OU BLACK.

POLIMENTO - ALUMÍNIO.

MESA: LÂMINA NATURAL - CARVALHO NATURAL, CARVALHO EBANIZADO, CARVALHO LINEN OU NOGUEIRA.

OPCIONAIS: CARREGADOR USB NO BRAÇO (CABO DE ALIMENTAÇÃO PARA TOMADA PADRÃO DO BRASIL OU EUA).

OBSERVAÇÕES: AS CONFIGURAÇÕES DE CHAISE TERÃO UMA COSTURA ADICIONAL NA PARTE SUPERIOR DO ASSENTO, DEVIDO AS DIMENÇÕES DO TECIDO. AS CONFIGURAÇÕES DE MÓDULO DUPLO SÃO UNIDAS COM ENGATES, AS ALMOFADAS SÃO UNIDAS PELO ROLINHO E OS MESMOS SÃO EMBALADOS EM UM ÚNICO VOLUME.

DESCRIPTION OF PRODUCT

SEAT: FIXED - ZIG ZAG SPRING + D33 + HR + D26 ULTRACEL + FIBER.

BACKREST: FIXED - D23 HYPER + D33 + D20 SOFT + FIBER.

BACKREST CUSHION: LOOSE - D23 HYPER + D26 ULTRACEL + FIBER.

LUMBAR CUSHION: LOOSE - D23 HYPER + D26 ULTRACEL + FIBER.

BASE: ELECTROSTATIC PAINTING - LEAD, BROWN OR BLACK.

POLISHING - ALUMINUM.

TABLE: NATURAL VENEER - NATURAL OAK, EBANIZED OAK, OAK LINEN OR WALNUT.

OPTIONAL: USB CHARGER IN THE ARMREST (POWER CORD TO STANDARD BRAZIL OR US OUTLET).

NOTES: "CHAISE CONFIGURATIONS WILL HAVE AN ADDITIONAL SEAM AT THE TOP OF THE SEAT DUE TO FABRIC DIMENSIONS.

DOUBLE MODULE CONFIGURATIONS ARE JOINED WITH HITCHES, THE CUSHIONS ARE JOINED BY THE ROLL AND THEY ARE PACKAGED IN A SINGLE PACKING."

DESCRIPCIÓN DEL PRODUCTO

ASIENTO: FIJO - MOLA EN ZIGZAG + D33 + HR + D26 ULTRACEL + FIBRA.

RESPALDO: FIJO - D23 HIPER + D33 + D20 SOFT + FIBRA.

ALMOHADA DE RESPALDO: SUELTO - D23 HIPER + D26 ULTRACEL + FIBRA.

ALMOHADA ESPALDA BAJA: SUELTO - D23 HIPER + D26 ULTRACEL + FIBRA.

BASE: PINTURA ELECTROSTÁTICA - PLOMO, MARRÓN O NEGRO.

PULIDO - ALUMINIO.

MESA: CHAPA NATURAL - ROBLE NATURAL, ROBLE EBANIZADO, ROBLE LINO O NOGAL.

OPCIONAL: CARGADOR USB EN EL BRAZO (CABLE DE ALIMENTACIÓN A ENCHUFE ESTÁNDAR EN BRASIL O EE. UU.).

OBSERVACIONES: LAS CONFIGURACIONES DE CHAISE TENDRÁN UNA COSTURA ADICIONAL EN LA PARTE SUPERIOR DEL ASIENTO DEBIDO A LAS DIMENSIONES DE LA TELA. LAS CONFIGURACIONES DE MÓDULOS DOBLES SE UNEN CON ENGANCHES, LAS ALMOHADAS SE UNEN POR EL ROLLITO Y SE EMPAQUETAN EN UN SOLO VOLUMEN.



BLEND

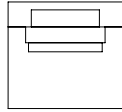

Configurações com 1 assento e sem braço

Módulo 85 - 1ass(85) + 1alm/enc(60x45) + 1alm/rim(50x25)
Módulo 101 - 1ass(101) + 1alm/enc(75x45) + 1alm/rim(65x25)

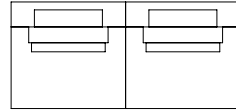

Configuração com 2 assentos e sem braço

Módulo 170 - 2ass(85) + 2alm/enc(60x45) + 2alm/rim(50x25)
Módulo 202 - 2ass(101) + 2alm/enc(75x45) + 2alm/rim(65x25)

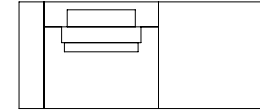

Configurações com 1 assento, 1 braço e 1 puff

Módulo 191 - 1ass(85) + 1puff(85) + 1br(21) + 1alm/enc(60x45) + 1alm/rim(50x25)
Módulo 223 - 1ass(101) + 1puff(101) + 1br(21) + 1alm/enc(75x45) + 1alm/rim(65x25)

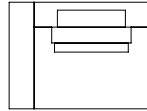

Configurações com 1 assento e 1 braço

Módulo 106 - 1ass(85) + 1br(21) + 1alm/enc(60x45) + 1alm/rim(50x25)
Módulo 122 - 1ass(101) + 1br(21) + 1alm/enc(75x45) + 1alm/rim(65x25)

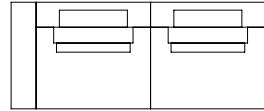

Configurações com 2 assentos e 1 braço

Módulo 191 - 1ass(85) + 1br(21) + 2alm/enc(60x45) + 2alm/rim(50x25)
Módulo 223 - 1ass(101) + 1br(21) + 2alm/enc(75x45) + 2alm/rim(65x25)

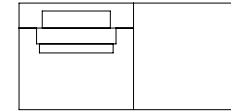

Configurações com 1 assento e 1 puff

Módulo 170 - 1ass(85) + 1puff(85) + 1alm/enc(60x45) + 1alm/rim(50x25)
Módulo 202 - 1ass(101) + 1puff(101) + 1alm/enc(75x45) + 1alm/rim(65x25)

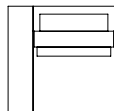

Configuração de canto

Canto 94 - 1ass(73) + 1br/enc(21) + 1alm/enc(60x45) + 1alm/rim(50x25)

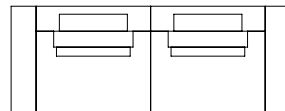

Configurações com 2 assentos e 2 braços

Módulo 212 - 2ass(85) + 2br(21) + 2alm/enc(60x45) + 2alm/rim(50x25)
Módulo 244 - 2ass(101) + 2br(21) + 2alm/enc(75x45) + 2alm/rim(65x25)



Configurações puff

Puff 62 - 1puff(62x62)
Puff 101 - 1puff(101x94)
Puff 110 - 1puff(110x110)
Puff 121 - 1puff(121x62)
Puff 130 - 1puff(130x130)
Puff 158 - 1puff(158x50)
Puff 163 - 1puff(163x70)
Puff canto 94 - 1puff(94x94)

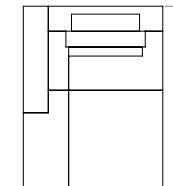

Configurações de chaise

Chaise 120 - 1ass(99) + 1br(21) + 1alm/enc(75x45) + 1alm/rim(65x25)
Chaise 140 - 1ass(119) + 1br(21) + 1alm/enc(90x45) + 1alm/rim(80x25)

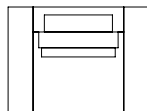

Configuração de poltrona

Poltrona 115 - 1ass(73) + 2br(21) + 1alm/enc(60x45) + 1alm/rim(50/25)

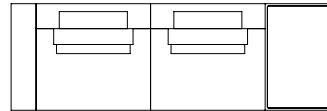

Configurações com 2 assentos, 1 braço e 1 mesa

Módulo 281 - 2ass(100) + 1br(21) + 1mesa(60) + 2alm/enc(74x45) + 2alm/rim(64x25)
Módulo 301 - 2ass(110) + 1br(21) + 1mesa(60) + 2alm/enc(84x45) + 2alm/rim(74x25)

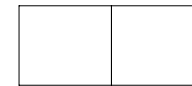

Configuração de puff duplo

Puff duplo 163 - 2puff(81,5x70)

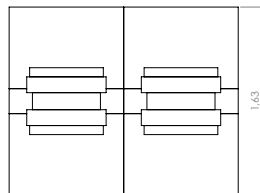
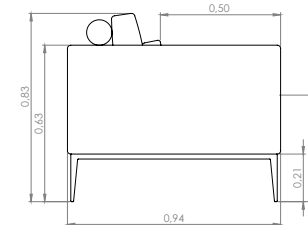

Configurações com 2 assentos duplos

Módulo duplo 170 - 4ass(85) + 4alm/enc(60x45) + 4alm/rim(50x25)
Módulo duplo 202 - 4ass(101) + 4alm/enc(75x45) + 4alm/rim(65x25)

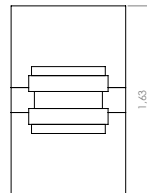

Configurações com 1 assento duplo

Módulo duplo 85 - 2ass(85) + 2alm/enc(60x45) + 2alm/rim(50x25)
Módulo duplo 101 - 2ass(101) + 2alm/enc(75x45) + 2alm/rim(65x25)



BLEND DUPLO





BLEND DUPLO

BLOCK

Design MAURICIO BOMFIM



BLOCK

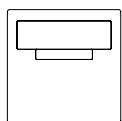

Configurações de puff com 1 rolinho

Puff 85 - 1puff(85x100) + 1rol(72x25) + 1alm/enc(50x50)
 Puff 100 - 1puff(100x100) + 1rol(72x25) + 1alm/enc(50x50)

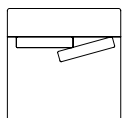

Configurações com 1 assento e 2 almofadas

Módulo 85 - 1ass(85) + 2alm/enc(50x50)
 Módulo 100 - 1ass(100) + 2alm/enc(50x50)

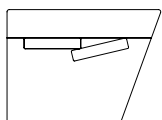

Configurações de 1 assento com ângulo e 2 almofadas

Módulo 123 - 1ass(85) c/âng + 2alm/enc(50x50)
 Módulo 138 - 1ass(100) c/âng + 2alm/enc(50x50)

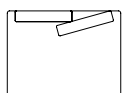

Configurações com 1 assento invertido e 2 almofadas

Módulo 85 - 1ass(85x75) + 2alm/enc(50x50)
 Módulo 100 - 1ass(100x75) + 2alm/enc(50x50)



Configuração de puff

Puff 65 - 1puff(65x100)

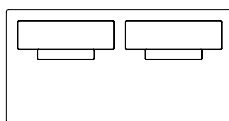

Configurações de puff com 2 rolinhos

Puff 170 - 1puff(170x100) + 2rol(72x25) + 2alm/enc(50x50)
 Puff 200 - 1puff(200x100) + 2rol(72x25) + 2alm/enc(50x50)

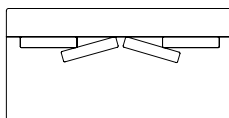

Configurações com 1 assento e 4 almofadas

Módulo 170 - 1ass(170) + 4alm/enc(50x50)
 Módulo 200 - 1ass(200) + 4alm/enc(50x50)

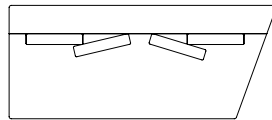

Configurações de 1 assento com ângulo e 4 almofadas

Módulo 208 - 1ass(170) c/âng + 4alm/enc(50x50)
 Módulo 238 - 1ass(200) c/âng + 4alm/enc(50x50)

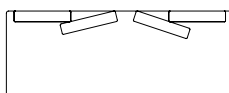

Configurações com 1 assento invertido e 4 almofadas

Módulo 170 - 1ass(170x75) + 4alm/enc(50x50)
 Módulo 200 - 1ass(200x75) + 4alm/enc(50x50)



Configuração de almofada

Alm/enc(50x50)



Configuração de rolinho

Rol(75x25)

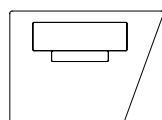

Configurações de puff com ângulo e 1 rolinho

Puff 123 - 1puff(85x100) c/âng + 1rol(72x25) + 1alm/enc(50x50)
 Puff 138 - 1puff(100x100) c/âng + 1rol(72x25) + 1alm/enc(50x50)

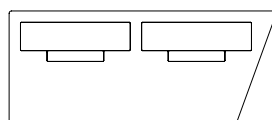

Configurações de puff com ângulo e 2 rolinhos

Puff 208 - 1puff(170x100) c/âng + 2rol(72x25) + 2alm/enc(50x50)
 Puff 238 - 1puff(200x100) c/âng + 2rol(72x25) + 2alm/enc(50x50)

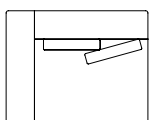

Configurações com 1 assento, 1 braço e 2 almofadas

Módulo 110 - 1ass(85) + 1br(25) + 2alm/enc(50x50)
 Módulo 125 - 1ass(100) + 1br(25) + 2alm/enc(50x50)

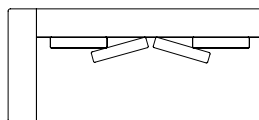

Configurações com 1 assento, 1 braço e 4 almofadas

Módulo 195 - 1ass(170) + 1br(25) + 4alm/enc(50x50)
 Módulo 225 - 1ass(200) + 1br(25) + 4alm/enc(50x50)

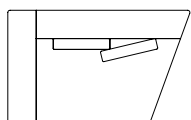

Configurações de 1 assento com ângulo, 1 braço e 2 almofadas

Módulo 148 - 1ass(85) c/âng + 1br(25) + 2alm/enc(50x50)
 Módulo 163 - 1ass(100) c/âng + 1br(25) + 2alm/enc(50x50)

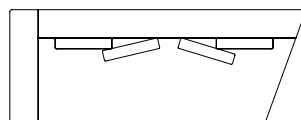

Configurações de 1 assento com ângulo, 1 braço e 4 almofadas

Módulo 233 - 1ass(170) c/âng + 1br(25) + 4alm/enc(50x50)
 Módulo 263 - 1ass(200) c/âng + 1br(25) + 4alm/enc(50x50)

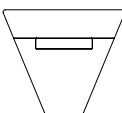

Configuração de 1 assento com ângulo dos dois lados

Módulo 45° - 1ass(108) + 1alm/enc(50x50)

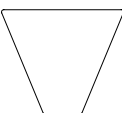

Configuração de puff com ângulo dos dois lados

Puff 45° - 1puff(108x95)

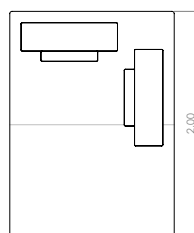

Configurações de puff chaise com rolinho

Puff Chaise 100 - 1puff(100x200) + 2rol(72x25) + 2alm/enc(50x50)
 Puff Chaise 145 - 1puff(145x200) + 2rol(72x25) + 2alm/enc(50x50)

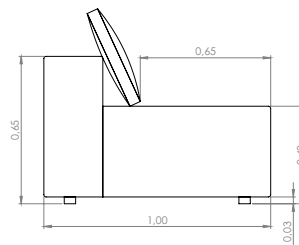

Configurações de chaise

Chaise 100 - 1ass(100) + 1alm/enc(50x50)
 Chaise 145 - 1ass(145) + 2alm/enc(50x50)

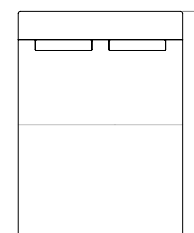

Configurações de chaise com braço

Chaise 125 - 1ass(100) + 1br(25) + 1alm/enc(50x50)
 Chaise 170 - 1ass(145) + 1br(25) + 2alm/enc(50x50)

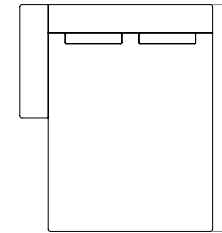

DESCRIÇÃO DO PRODUTO

ASSENTO: FIXO - PERCINTA + HR + D33 + D20 SOFT + FIBRA.

ENCOSTO: FIXO - D33 + D20 SOFT + FIBRA.

ALMOFADA DECORATIVA: SOLTA - ALGODÃO + D26 ULTRACEL + FIBRA.

ROLINHO: SOLTO - HR + FIBRA.

PÉ: IMBUÍDA.

OPCIONAIS: CARREGADOR USB NO BRAÇO (CABO DE ALIMENTAÇÃO PARA TOMADA PADRÃO DO BRASIL OU EUA).

COSTURA COM DEBRUM.

OBSERVAÇÕES: EM TODAS AS PEÇAS COM ÂNGULO, A MEDIDA DESCRITA REFERE-SE AO ESPAÇO QUE A MESMA OCUPARÁ NO AMBIENTE. A MEDIDA DO ASSENTO REFERE-SE A PARTE DA FRENTE DA PEÇA. O MÓDULO CHAISE TEM UMA COSTURA CENTRALIZADA DEVIDO A LARGURA DO TECIDO. POSSIBILIDADE DE TRABALHAR COM MEDIDAS ESPECIAIS NA LARGURA E PROFUNDIDADE. A ALTERAÇÃO DA LARGURA É SEMPRE APLICADA NO ASSENTO, ENCOSTO E ROLINHO NÃO SE ALTERAM. COM EXCEÇÃO DAS OPÇÕES DE ASSENTO INVERTIDO, NENHUM MÓDULO ACOMPANHA ENGATE PARA FIXAÇÃO.

A COSTURA COM DEBRUM ESTÁ INDISPONÍVEL EM COURO E RECOURO, E SE A MESMA FOR EM TECIDO DIFERENTE DO MÓDULO, A METRAGEM DE TECIDO DEVE SER CONSULTADA.

PRODUTO INDISPONÍVEL EM COURO.

DESCRIPTION OF PRODUCT

SEAT: FIXED – ELASTIC BELT + HR + D33 + D20 SOFT + FIBER.

BACKREST: FIXED - D33 + D20 SOFT + FIBER.

DECORATIVE CUSHION: LOOSE - COTTON + D26 ULTRACEL + FIBER.

ROLL CUSHION: LOOSE - HR + FIBER.

FOOT: IMBUÍDA.

OPTIONAL: USB CHARGER IN THE ARMREST (POWER CORD TO STANDARD BRAZIL OR US OUTLET).

DEBRUM SEAM.

NOTE: IN ALL PIECES WITH ANGLE, THE MEASURE DESCRIBED REFERS TO THE SPACE IT WILL TAKE IN THE ROOM. THE MEASURE OF THE SEAT REFERS TO THE FRONT PART OF THE PIECE. THE CHAISE MODULE HAS A CENTRALIZED SEAM DUE TO THE WIDTH OF THE FABRIC.

IT IS POSSIBLE TO WORK WITH SPECIAL MEASUREMENTS IN WIDTH AND DEPTH. WIDTH CHANGING IS ALWAYS APPLIED TO THE SEAT, BACKREST AND ROLL CUSHIONS DO NOT CHANGE.

WITH THE EXCEPTION OF THE INVERTED SEAT OPTIONS, NO MODULE COMES WITH A FASTENING CLAMP. THE SEAM WITH DEBRUM IS NOT AVAILABLE IN LEATHER AND LEATHER FIBERS, AND IF IT IS IN FABRIC OTHER THAN THE MODULE, THE FABRIC FOOTAGE MUST BE CONSULTED.

PRODUCT UNAVAILABLE IN LEATHER.

DESCRIPCIÓN DEL PRODUCTO

ASIENTO: FIJO – CINTURÓN ELÁSTICO + HR + D33 + D20 SUAVE + FIBRA.

RESPALDO: FIJO - D33 + D20 BLANDO + FIBRA.

ALMOHADA DECORATIVA: SUELTA - ALGODÓN + D26 ULTRACEL + FIBRA.

ALMOHADA ROLLITO: SUELTO - HR + FIBRA.

PIE: IMBUÍDA.

OPCIONAL: CARGADOR USB EN EL BRAZO (CABLE DE ALIMENTACIÓN A ENCHUFE ESTÁNDAR EN BRASIL O EE. UU.).

COSIDO DE RIBETE.

OBSERVACIONES: PARA TODAS LAS PIEZAS CON ÂNGULO, LA MEDIDA DESCRITA SE REFIERE AL ESPACIO QUE OCUPARÁ EN LA HABITACIÓN. LA MEDIDA DEL ASIENTO SE REFIERE A LA PARTE DELANTERA DE LA PIEZA. EL MÓDULO DE LA CHAISE TIENE UNA COSTURA CENTRALIZADA DEBIDO A LA ANCHURA DE LA TELA.

ES POSIBLE TRABAJAR CON MEDIDAS ESPECIALES EN ANCHURA Y PROFUNDIDAD. LA ALTERACIÓN DE LA ANCHURA SE APLICA SIEMPRE AL ASIENTO, EL RESPALDO Y LOS RODILLOS NO CAMBIAN.

A EXCEPCIÓN DE LAS OPCIONES DE ASIENTO INVERTIDO, NINGÚN MÓDULO VIENE CON UNA PRESILLA DE FIJACIÓN. EL COSIDO DE RIBETE NO ESTÁ DISPONIBLE EN CUERO Y FIBRAS DE CUERO, Y SI ES EN TELA DIFERENTE AL MÓDULO, SE DEBE CONSULTAR EL METRAJE DE LA TELA.

PRODUCTO NO DISPONIBLE EN PIEL.



BLOCK





SOHO

Design STUDIO FEELING



DESCRIÇÃO DO PRODUTO

ASSENTO: SOLTO - MOLA + HR + D26 ULTRACEL + FIBRA.

ENCOSTO: FIXO - PERCINTA + D20 SOFT.

ALMOFADA DE ENCOSTO: SOLTA - D23 HIPER + D26 ULTRACEL + FIBRA.

ALMOFADA DE BRAÇO: SOLTA - ALGODÃO + FIBRA SILICONADA.

ROLINHO ENCOSTO: SOLTO - D33 + FIBRA.

PÉ: PRETO.

OPCIONAIS: CARREGADOR USB NO BRAÇO (CABO DE ALIMENTAÇÃO PARA TOMADA PADRÃO DO BRASIL OU EUA).

DESCRIPTION OF PRODUCT

SEAT: LOOSE - SPRING + HR + D26 ULTRACEL + FIBER.

BACKREST: FIXED - ELASTIC BELT + D20 SOFT.

BACKREST CUSHION: LOOSE - D23 HYPER + D26 ULTRACEL + FIBER.

ARMREST CUSHION: LOOSE - COTTON + SILICONIZED FIBER.

BACKREST ROLL CUSHION: LOOSE - D33 + FIBER.

FOOT: BLACK

OPTIONAL: USB CHARGER IN THE ARMREST (POWER CORD TO STANDARD BRAZIL OR US OUTLET).

DESCRIPCIÓN DEL PRODUCTO

ASIENTO: SUELTO - RESORTE + HR + D26 ULTRACEL + FIBRA.

RESPALDO: FIJO - CINTURÓN ELÁSTICO + D20 SUAVE.

ALMOHADA DE RESPALDO: SUELTO - D23 HIPER + D26 ULTRACEL + FIBRA.

ALMOHADA DE BRAZO: SUELTO - ALGODÓN + FIBRA DE SILICONA.

ALMOHADA ROLLITO DE RESPALDO: SUELTO - D33 + FIBRA.

PIE: NEGRO.

OPCIONAL: CARGADOR USB EN EL BRAZO (CABLE DE ALIMENTACIÓN A ENCHUFE ESTÁNDAR EN BRASIL O EE. UU.).

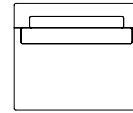

Configurações com 1 assento e sem braço

Módulo 95 - 1ass(95) + 1alm/enc(83x45) + 1rol/enc(68x12)
Módulo 110 - 1ass(110) + 1alm/enc(98x45) + 1rol/enc(83x12)

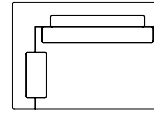

Configurações com 1 assento e 1 braço

Módulo 115 - 1ass(95) + 1br(20) + 1alm/enc(83x45) + 1alm/br(50x50) + 1rol/enc(68x12)
Módulo 130 - 1ass(110) + 1br(20) + 1alm/enc(98x45) + 1alm/br(50x50) + 1rol/enc(83x12)



Configurações de puff

Puff 110 - 1puff(110x94)
Puff canto 94 - 1puff(94x94)

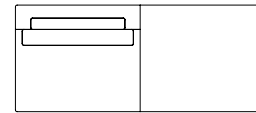

Configurações com 1 assento e 1 puff

Módulo 190 - 1ass(95) + 1puff(95) + 1alm/enc(83x45) + 1rol/enc(68x12)
Módulo 220 - 1ass(110) + 1puff(110) + 1alm/enc(98x45) + 1rol/enc(83x12)

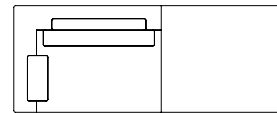

Configurações com 1 assento, 1 puff e 1 braço

Módulo 210 - 1ass(95) + 1puff(95) + 1br(20) + 1alm/enc(83x45) + 1alm/br(50x50) + 1rol/enc(68x12)
Módulo 240 - 1ass(110) + 1puff(110) + 1br(20) + 1alm/enc(98x45) + 1alm/br(50x50) + 1rol/enc(83x12)

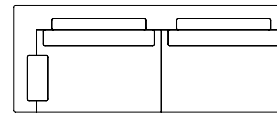

Configurações com 2 assentos e 1 braço

Módulo 210 - 2ass(95) + 1br(20) + 2alm/enc(83x45) + 1alm/br(50x50) + 2rol/enc(68x12)
Módulo 240 - 2ass(110) + 1br(20) + 2alm/enc(98x45) + 1alm/br(50x50) + 2rol/enc(83x12)

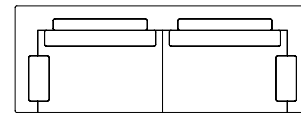

Configurações com 2 assentos e 2 braços

Módulo 230 - 2ass(95) + 2br(20) + 2alm/enc(83x45) + 2alm/br(50x50) + 2rol/enc(68x12)
Módulo 260 - 2ass(110) + 2br(20) + 2alm/enc(98x45) + 2alm/br(50x50) + 2rol/enc(83x12)

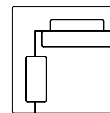

Configurações de canto

Canto 94 - 1ass(74) + 1br/enc(20) + 1alm/enc(62x45) + 1alm/br(50x50) + 1rol/enc(47x12)

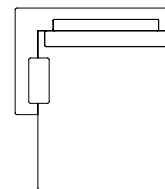

Configurações de chaise

Chaise 120 - 1ass(100) + 1br(20) + 1alm/enc(88x45) + 1alm/br(50x50) + 1rol/enc(73x12)
Chaise 140 - 1ass(120) + 1br(20) + 1alm/enc(108x45) + 1alm/br(50x50) + 1rol/enc(93x12)

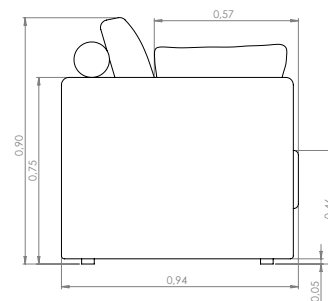

SOHO



MALIBU

Design PEDRO MENDES



DESCRIÇÃO DO PRODUTO

ASSENTO: FIXO - PERCINTA + D33 + D26 ULTRACEL + FIBRA.

ENCOSTO: FIXO - D20 SOFT + FIBRA.

ALMOFADA DE ENCOSTO: SOLTA - FIBRA SILICONADA.

ALMOFADA DE RIM: SOLTA - D26 ULTRACEL + ALGODÃO + FIBRA.

ALMOFADA DECORATIVA: SOLTA - FIBRA SILICONADA.

PÉ: PRETO.

MESA: LÂMINA NATURAL - CARVALHO NATURAL, CARVALHO EBANIZADO, CARVALHO LINEN OU NOGUEIRA. PINTURA ELETROSTÁTICA - CHUMBO, MARROM OU BLACK.

OPCIONAIS: CARREGADOR USB NO BRAÇO (23) (CABO DE ALIMENTAÇÃO PARA TOMADA PADRÃO DO BRASIL OU EUA).

DESCRIPTION OF PRODUCT

SEAT: FIXED - ELASTIC BELT + D33 + D26 ULTRACEL + FIBER.

BACKREST: FIXED - D20 SOFT + FIBER.

BACKREST CUSHION: LOOSE - SILICONIZED FIBER.

LUMBAR CUSHION: LOOSE - D26 ULTRACEL + COTTON + FIBER.

DECORATIVE CUSHION: LOOSE - SILICONIZED FIBER. **FOOT:** BLACK.

TABLE: NATURAL VENEER - NATURAL OAK, EBANIZED OAK, OAK LINEN OR WALNUT.

ELECTROSTATIC PAINT - LEAD, BROWN OR BLACK.

OPTIONAL: USB CHARGER IN THE ARMREST (23) (POWER CORD TO STANDARD BRAZIL OR US OUTLET).

DESCRIPCIÓN DEL PRODUCTO

ASIENTO: FIJO - CINTURÓN ELÁSTICO + D33 + D26 ULTRACEL + FIBRA.

RESPALDO: FIJO - D20 SUAVE + FIBRA.

ALMOHADA DE RESPALDO: SUELTO - FIBRA SILICONADA.

ALMOHADA ESPALDA BAJA: SUELTO - D26 ULTRACEL + ALGODÓN + FIBRA.

ALMOHADA DECORATIVA: SUELTO - FIBRA SILICONADA.

PIE: NEGRO.

MESA: CHAPA NATURAL - ROBLE NATURAL, ROBLE EBANIZADO, ROBLE LINO O NOGAL.

PINTURA ELETROSTÁTICA - PLOMO, MARRÓN O NEGRO.

OPCIONAL: CARGADOR USB EN EL BRAZO (23) (CABLE DE ALIMENTACIÓN A ENCHUFE ESTÁNDAR EN BRASIL O EE. UU.).

MALIBU

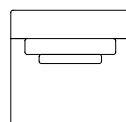

Cofigurações com 1 assento e sem braço

Módulo 85 - 1ass(85) + 1alm/enc(65x45) + 1alm/rim(45x40)
Módulo 105 - 1ass(105) + 1alm/enc(85x45) + 1alm/rim(65x40)

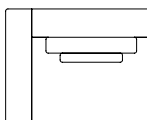

Cofigurações com 1 assento e 1 braço baixo

Módulo 108 - 1ass(85) + 1br/baixo(23) + 1alm/enc(65x45) + 1alm/rim(45x40)
Módulo 128 - 1ass(105) + 1br/baixo(23) + 1alm/enc(85x45) + 1alm/rim(65x40)

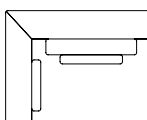

Cofigurações com 1 assento e 1 braço/encosto

Módulo 108 - 1ass(85) + 1br/enc(23) + 1alm/enc(65x45) + 1alm/rim(45x40) + 1alm/dec(45x45)
Módulo 128 - 1ass(105) + 1br/enc(23) + 1alm/enc(85x45) + 1alm/rim(65x40) + 1alm/dec(45x45)

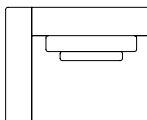

Cofigurações com 1 assento e 1 braço/mesa

Módulo 113 - 1ass(85) + 1br/mesa(28) + 1alm/enc(65x45) + 1alm/rim(45x40)
Módulo 133 - 1ass(105) + 1br/mesa(28) + 1alm/enc(85x45) + 1alm/rim(65x40)

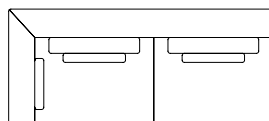

Cofigurações com 2 assentos e 1 braço/encosto

Módulo 193 - 2ass(85) + 1br/enc(23) + 2alm/enc(65x45) + 2alm/rim(45x40) + 1alm/dec(45x45)
Módulo 233 - 2ass(105) + 1br/enc(23) + 2alm/enc(85x45) + 2alm/rim(65x40) + 1alm/dec(45x45)

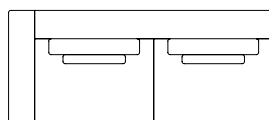

Cofigurações com 2 assentos e 1 braço baixo

Módulo 193 - 2ass(85) + 1br/baixo(23) + 2alm/enc(65x45) + 2alm/rim(45x40)
Módulo 233 - 2ass(105) + 1br/baixo(23) + 2alm/enc(85x45) + 2alm/rim(65x40)

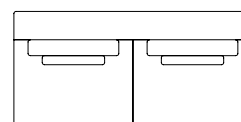

Cofigurações com 2 assentos e sem braço

Módulo 170 - 2ass(85) + 2alm/enc(65x45) + 2alm/rim(45x40)
Módulo 210 - 2ass(105) + 2alm/enc(85x45) + 2alm/rim(65x40)

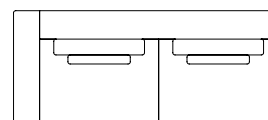

Cofigurações com 2 assentos e 1 braço/mesa

Módulo 198 - 2ass(85) + 1br/mesa(28) + 2alm/enc(65x45) + 2alm/rim(45x40)
Módulo 238 - 2ass(105) + 1br/mesa(28) + 2alm/enc(85x45) + 2alm/rim(65x40)

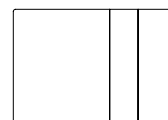

Cofigurações de Puff com Mesa

Puff 145 - 1puff(85x102) + 1mesa(60x102)
Puff 165 - 1puff(105x102) + 1mesa(60x102)



Cofigurações de Puff

Puff 85 - 1puff(85x102)
Puff 105 - 1puff(105x102)
Puff canto - 1puff(102x102)

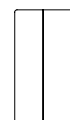

Cofiguração de Mesa

Mesa 60 - 1mesa(60x102))

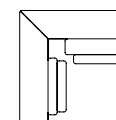

Cofigurações de Canto

Canto 102 - 1ass(79) + 1br/enc(23) + 1alm/enc(65x45) + 2alm/dec(45x45) + 1alm/rim(50x40)

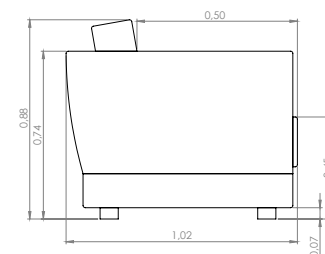

ALLEGRO

Design STUDIO FEELING



DESCRIÇÃO DO PRODUTO

ASSENTO: FIXO - PERCINTA + D33 + D20 SOFT + FIBRA.

ENCOSTO: FIXO - D20 SOFT.

ALMOFADA DE ENCOSTO: SOLTA - HR + D26 ULTRACEL + FIBRA.

PÉ: PRETO.

BASE: POLIDO - ALUMÍNIO.

MESA: LÂMINA NATURAL - CARVALHO NATURAL, CARVALHO EBANIZADO, CARVALHO LINEN OU NOGUEIRA.

PINTURA LACA: PRETO, BRANCO, FENDI OU NUDE.

OPCIONAIS: CARREGADOR USB NO BRAÇO (CABO DE ALIMENTAÇÃO PARA TOMADA PADRÃO DO BRASIL OU EUA).

DESCRIPCIÓN DEL PRODUCTO

SEAT: FIXED - ELASTIC BELT + D33 + D20 SOFT + FIBER.

BACKREST: FIXED - D20 SOFT.

BACKREST CUSHION: LOOSE - HR + D26 ULTRACEL + FIBER.

FOOT: BLACK.

BASE: POLISHED - ALUMINUM.

TABLE: NATURAL VENEER - NATURAL OAK, EBANIZED OAK, OAK LINEN OR WALNUT. LACQUER PAINT - BLACK, WHITE, FENDI OR NUDE.

OPTIONAL: USB CHARGER IN THE ARMREST (POWER CORD TO STANDARD BRAZIL OR US OUTLET).

DESCRIPTION OF PRODUCT

ASIENTO: FIJO - CINTURÓN ELÁSTICO + D33 + D20 SUAVE + FIBRA.

RESPALDO: FIJO - D20 SUAVE.

ALMOHADA DE RESPALDO: SUELTA - HR + D26 ULTRACEL + FIBRA.

PIE: NEGRO.

BASE: PULIDO - ALUMINIO.

MESA: "CHAPA NATURAL - ROBLE NATURAL, ROBLE EBANIZADO, ROBLE LINO O NOGAL.

PINTURA DE LACA: NEGRA, BLANCA, FENDI O NUDE".

OPCIONAL: CARGADOR USB EN EL BRAZO (CABLE DE ALIMENTACIÓN A ENCHUFE ESTÁNDAR EN BRASIL O EE. UU.).

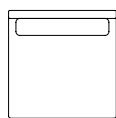

Configurações com 1 assento e sem braço

Módulo 100 - 1ass(100) + 1alm/enc(90x45)

Módulo 115 - 1ass(115) + 1alm/enc(105x45)

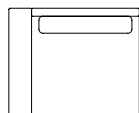

Configuração com 1 assento e 1 braço

Módulo 123 - 1ass(100) + 1br(23) + 1alm/enc(90x45)

Módulo 138 - 1ass(115) + 1br(23) + 1alm/enc(105x45)

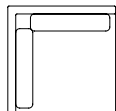

Configuração de canto

Canto 95 - 1ass(72) + 1br/enc(23) + 2alm/enc(65x45)



Configurações de Puff

Puff canto 95 - 1puff(95x95)

Puff 70 - 1puff(70x78)

Puff 85 - 1puff(85x78)

Puff 100 - 1puff(100x78)

Puff 115 - 1puff(115x78)



Configuração de mesa

Mesa canto 95 - 1mesa(95x95)

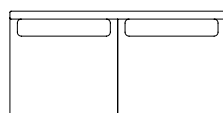

Configurações com 2 assentos e sem braço

Módulo 170 - 2ass(85) + 2alm/enc(75x45)

Módulo 200 - 2ass(100) + 2alm/enc(90x45)

Módulo 230 - 2ass(115) + 2alm/enc(105x45)

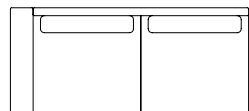

Configurações com 2 assentos e 1 braço

Módulo 163 - 2ass(70) + 1br(23) + 2alm/enc(60x45)

Módulo 193 - 2ass(85) + 1br(23) + 2alm/enc(75x45)

Módulo 223 - 2ass(100) + 1br(23) + 2alm/enc(90x45)

Módulo 253 - 2ass(115) + 1br(23) + 2alm/enc(105x45)

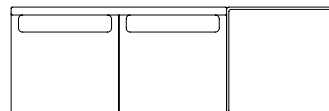

Configurações com 2 assentos e mesa

Módulo 200 - 2ass(70) + 1mesa(60) + 2alm/enc(60x45)

Módulo 230 - 2ass(85) + 1mesa(60) + 2alm/enc(75x45)

Módulo 260 - 2ass(100) + 1mesa(60) + 2alm/enc(90x45)

Módulo 290 - 2ass(115) + 1mesa(60) + 2alm/enc(105x45)

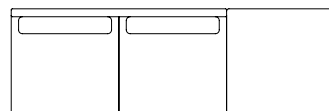

Configurações com 2 assentos e 1 puff

Módulo 200 - 2ass(70) + 1puff(60) + 2alm/enc(60x45)

Módulo 230 - 2ass(85) + 1puff(60) + 2alm/enc(75x45)

Módulo 260 - 2ass(100) + 1puff(60) + 2alm/enc(90x45)

Módulo 290 - 2ass(115) + 1puff(60) + 2alm/enc(105x45)

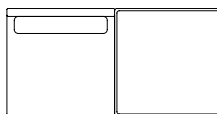

Configurações com 1 assento e 1 mesa

Módulo 160 - 1ass(100) + 1mesa(60) + 1alm/enc(90x45)

Módulo 175 - 1ass(115) + 1mesa(60) + 1alm/enc(105x45)

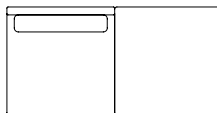

Configurações com 1 assento e 1 puff

Módulo 160 - 1ass(100) + 1puff(60) + 1alm/enc(90x45)

Módulo 175 - 1ass(115) + 1puff(60) + 1alm/enc(105x45)

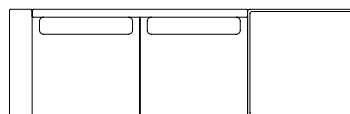

Configurações com 2 assentos, 1 braço e 1 mesa

Módulo 223 - 2ass(70) + 1br(23) + 1mesa(60) + 2alm/enc(60x45)

Módulo 253 - 2ass(85) + 1br(23) + 1mesa(60) + 2alm/enc(75x45)

Módulo 283 - 2ass(100) + 1br(23) + 1mesa(60) + 2alm/enc(90x45)

Módulo 313 - 2ass(115) + 1br(23) + 1mesa(60) + 2alm/enc(105x45)

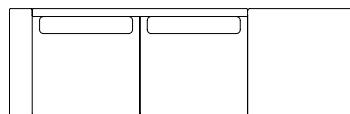

Configurações com 2 assentos, 1 braço e 1 puff

Módulo 223 - 2ass(70) + 1br(23) + 1puff(60) + 2alm/enc(60x45)

Módulo 253 - 2ass(85) + 1br(23) + 1puff(60) + 2alm/enc(75x45)

Módulo 283 - 2ass(100) + 1br(23) + 1puff(60) + 2alm/enc(90x45)

Módulo 313 - 2ass(115) + 1br(23) + 1puff(60) + 2alm/enc(105x45)

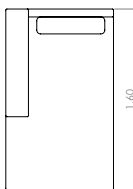

Configurações chaise

Chaise 123 - 1ass(100) + 1br(23) + 1alm/enc(90x45)

Chaise 138 - 1ass(115) + 1br(23) + 1alm/enc(105x45)

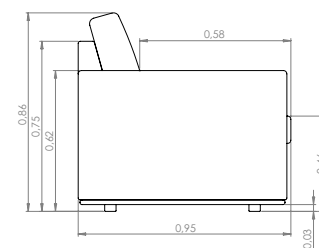

ALLEGRO

FEELING ESTOFADOS | Coleção Cotidiano

LOUNGE

Design STUDIO FEELING





LOUNGE

DESCRIÇÃO DO PRODUTO

ASSENTO: FIXO - MOLA + D33 + D26 ULTRACEL + FIBRA.

ENCOSTO: FIXO - D23 HIPER + D20 SOFT + D33 + FIBRA.

ALMOFADA DE ENCOSTO: SOLTA - D23 HIPER + D26 ULTRACEL + FIBRA.

PÉ: PINTURA ELETROSTÁTICA - CHUMBO, MARRON OU BLACK. POLIMENTO - ALUMÍNIO.

OPCIONAIS: CARREGADOR USB NO BRAÇO (CABO DE ALIMENTAÇÃO PARA TOMADA PADRÃO DO BRASIL OU EUA).

DESCRIPCIÓN DEL PRODUCTO

SEAT: FIXED - SPRING + D33 + D26 ULTRACEL + FIBER.

BACKREST: FIXED - D23 HYPER + D20 SOFT + D33 + FIBER.

BACKREST CUSHION: LOOSE - D23 HYPER + D26 ULTRACEL + FIBER.

FOOT: ELECTROSTATIC PAINTING - LEAD, BROWN OR BLACK. POLISHING - ALUMINUM.

OPTIONAL: USB CHARGER IN THE ARMREST (POWER CORD TO STANDARD BRAZIL OR US OUTLET).

DESCRIPTION OF PRODUCT

ASIENTO: FIJO - RESORTE + D33 + D26 ULTRACEL + FIBRA.

RESPALDO: FIJO - D23 HIPER + D20 SOFT + D33 + FIBRA.

ALMOHADA DE RESPALDO: SUELTO - D23 HIPER + D26 ULTRACEL + FIBRA.

PIE: PINTURA ELECTROSTÁTICA - PLOMO, MARRÓN O NEGRO. PULIDO - ALUMINIO.

OPCIONAL: CARGADOR USB EN EL BRAZO (CABLE DE ALIMENTACIÓN A ENCHUFE ESTÁNDAR EN BRASIL O EE. UU.).

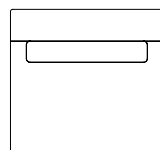

Configurações com 1 assento e sem braço

Módulo 85 - 1ass(85) + 1alm/enc(64x42)
Módulo 101 - 1ass(101) + 1alm/enc(80x42)

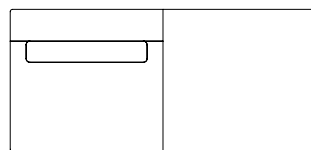

Configurações com 1 assento e 1 puff

Módulo 170 - 1ass(85) + 1puff(85) + 1alm/enc(64x42)
Módulo 202 - 1ass(101) + 1puff(101) + 1alm/enc(80x42)

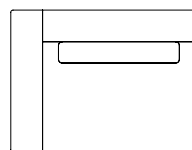

Configurações com 1 assento e 1 braço

Módulo 106 - 1ass(85) + 1br(21) + 1alm/enc(64x42)
Módulo 122 - 1ass(101) + 1br(21) + 1alm/enc(80x42)

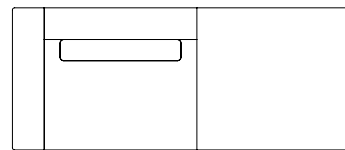

Configurações com 1 assento, 1 puff e 1 braço

Módulo 191 - 1ass(85) + 1puff(85) + 1br(21) + 1alm/enc(64x42)
Módulo 223 - 1ass(101) + 1puff(101) + 1br(21) + 1alm/enc(80x42)

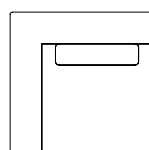

Configuração de Canto

Canto 94 - 1ass(73) + 1br/enc(21) + 1alm/enc(52x42)

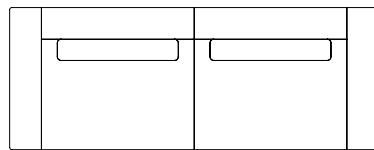

Configurações com 2 assentos e 2 braços

Módulo 212 - 2ass(85) + 2br(21) + 2alm/enc(64x42)
Módulo 244 - 2ass(101) + 2br(21) + 2alm/enc(80x42)

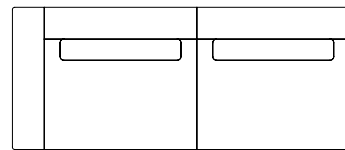

Configurações com 2 assentos e 1 braço

Módulo 191 - 2ass(85) + 1br(21) + 2alm/enc(64x42)
Módulo 223 - 2ass(101) + 1br(21) + 2alm/enc(80x42)

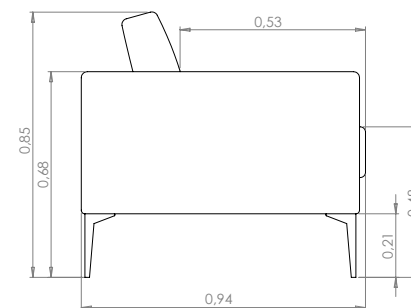

SOFÁ-CAMA NOAH

Design DANIELA FERRO



ASSISTA O
CONCEITO
DESTE
PRODUTO



DESCRIÇÃO DO PRODUTO

ASSENTO: FIXO - MOLA ENSACADA + HR + D26 ULTRACEL + FIBRA.

ENCOSTO: FIXO - MOLA ENSACADA + HR + D26 ULTRACEL + FIBRA.

ALMOFADA DE ENCOSTO MAIOR: SOLTA - D20 SOFT + D26 ULTRACEL + FIBRA.

ALMOFADA DE ENCOSTO MENOR: SOLTA - FELTRO + D26 ULTRACEL + FIBRA.

PÉS: PINTURA ELETROSTÁTICA - CHUMBO, MARROM OU BLACK.
LÂMINA NATURAL - CARVALHO NATURAL, CARVALHO EBANIZADO,
CARVALHO LINEN OU NOGUEIRA.

OBSERVAÇÕES: OS PÉS LAMINADOS TEM COMO PADRÃO AS
BORDAS PINTADAS. PRODUTO INDISPONÍVEL PARA MEDIDAS
SUPERIORES A 2,20M DE LARGURA.

DESCRIPCIÓN DEL PRODUCTO

SEAT: FIXED - POCKET SPRING + HR + D26 ULTRACEL + FIBER.

BACKREST: FIXED - POCKET SPRING + HR + D26 ULTRACEL + FIBER.

LARGER BACKREST CUSHION: LOOSE - D20 SOFT + D26 ULTRACEL + FIBER.

SMALLER BACKREST CUSHION: LOOSE - FELT + D26 ULTRACEL + FIBER.

FOOT: ELECTROSTATIC PAINTING - LEAD, BROWN OR BLACK.
NATURAL VENEER - NATURAL OAK, EBANIZED OAK, OAK LINEN OR WALNUT.

NOTE: LAMINATED LEGS HAVE PAINTED EDGES AS STANDARD.
PRODUCT UNAVAILABLE FOR MEASURES OVER 2.20M IN WIDTH.

DESCRIPTION OF PRODUCT

ASIENTO: FIJO - RESORTE EMBOLSADO+ HR + D26 ULTRACEL + FIBRA.

RESPALDO: FIJO - RESORTE EMBOLSADO+ HR + D26 ULTRACEL + FIBRA.

ALMOHADA DE RESPALDO MÁS GRANDE: SUELTO - D20 SOFT + D26
ULTRACEL + FIBRA.

ALMOHADA DE RESPALDO MÁS PEQUEÑO: SUELTO - FIELTRO + D26
ULTRACEL + FIBRA.

PIES: PINTURA ELECTROSTÁTICA - PLOMO, MARRÓN O NEGRO.
CHAPA NATURAL - ROBLE NATURAL, ROBLE EBANIZADO, ROBLE LINO O
NOGAL.

OBSERVACIONES: LOS PIES LAMINADOS TIENEN BORDES PINTADOS POR
DEFECTO. PRODUCTO NO DISPONIBLE PARA MEDIDAS SUPERIORES A 2,20
M DE ANCHO.

NOAH

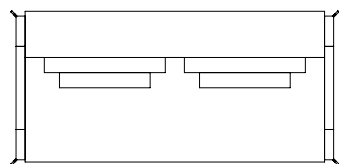

Configurações com 1 assento e 2 braços

Módulo 210 - 1 ass(188) + 2br(11) + 2alm/enc(80x45) + 2alm/enc(55x40)

Módulo 220 - 1 ass(198) + 2br(11) + 2alm/enc(85x45) + 2alm/enc(55x40)

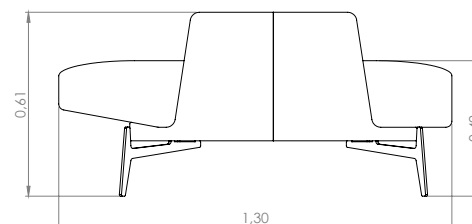
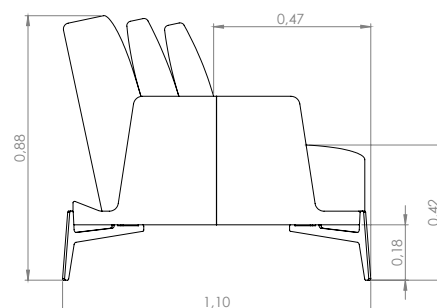

DIAMOND

Design STUDIO FEELING



DIAMOND

DESCRIÇÃO DO PRODUTO

ASSENTO: RETRÁTIL - PERCINTA + HR + D33 + FIBRA.

ENCOSTO: RECLINÁVEL - D33 + D26 ULTRACEL + D20 SOFT + FIBRA.

PÉ: IMBUÍDA.

OPCIONAIS: CARREGADOR USB NO BRAÇO (CABO DE ALIMENTAÇÃO PARA TOMADA PADRÃO DO BRASIL OU EUA).

OBSERVAÇÃO: MECANISMO DE ACIONAMENTO RETRÁTIL E RECLINÁVEL ELÉTRICOS.



DESCRIPTION OF PRODUCT

SEAT: RETRACTABLE - ELASTIC BELT + HR + D33 + FIBER.

BACKREST: RECLINING - D33 + D26 ULTRACEL + D20 SOFT + FIBER.

FOOT: IMBUÍDA.

OPTIONAL: USB CHARGER IN THE ARMREST (POWER CORD TO STANDARD BRAZIL OR US OUTLET).

NOTE: ELECTRIC RETRACTABLE AND RECLINING DRIVE MECHANISM.

DESCRIPCIÓN DEL PRODUCTO

ASIENTO: RETRÁCTIL - CINTURÓN ELÁSTICO + HR + D33 + FIBRA.

RESPALDO: RECLINABLE - D33 + D26 ULTRACEL + D20 SOFT + FIBRA.

PIE: IMBUÍDA.

OPCIONAL: CARGADOR USB EN EL BRAZO (CABLE DE ALIMENTACIÓN A ENCHUFE ESTÁNDAR EN BRASIL O EE. UU.).

NOTA: "MECANISMO DE ACCIONAMIENTO ELÉCTRICO RETRÁCTIL Y RECLINABLE.

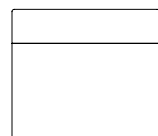

Configurações com 1 assento e sem braço

Módulo 90 - 1ass(90)
Módulo 100 - 1ass(100)
Módulo 110 - 1ass(110)
Módulo 120 - 1ass(120)
Módulo 130 - 1ass(130)

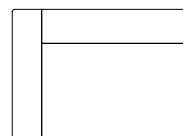

Configurações com 1 assento e 1 braço

Módulo 116 - 1ass(90) + 1br(26)
Módulo 126 - 1ass(100) + 1br(26)
Módulo 136 - 1ass(110) + 1br(26)
Módulo 146 - 1ass(120) + 1br(26)
Módulo 156 - 1ass(130) + 1br(26)

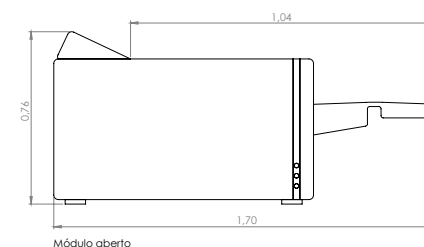

Módulo aberto

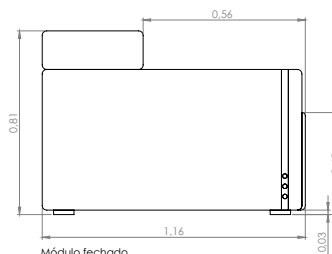

Módulo fechado



SOUL

Design STUDIO FEELING



DESCRIÇÃO DO PRODUTO

ASSENTO: FIXO - PERCINTA + HR + D20 SOFT + FIBRA.

ENCOSTO: SOLTO - D23 HIPER + D20 SOFT + FIBRA.

ALMOFADA DE RIM: SOLTA - D26 UTRACEL + FIBRA SILICONADA.

PÉ: IMBUÍDA.

OPCIONAIS: CARREGADOR USB NO BRAÇO (CABO DE ALIMENTAÇÃO PARA TOMADA PADRÃO DO BRASIL OU EUA).

OBSERVAÇÃO: PRODUTO INDISPONÍVEL EM COURO.

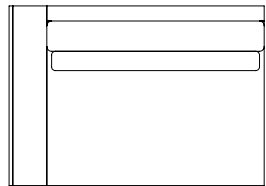

Configuração com 1 assento e 1 braço

Módulo 135 - 1ass(115) + 1br(20) + 1alm/enc(115x45) + 1alm/rim(110x24)

DESCRIPTION OF PRODUCT

SEAT: FIXED - ELASTIC BELT + HR + D20 SOFT + FIBER.

BACKREST: LOOSE - D23 HYPER + D20 SOFT + FIBER.

DECORATIVE CUSHION: LOOSE - D26 ULTRACEL + SILICONED FIBER.

FOOT: IMBUÍDA.

OPTIONAL: USB CHARGER IN THE ARMREST (POWER CORD TO STANDARD BRAZIL OR US OUTLET).

NOTE: PRODUCT NOT AVAILABLE IN LEATHER

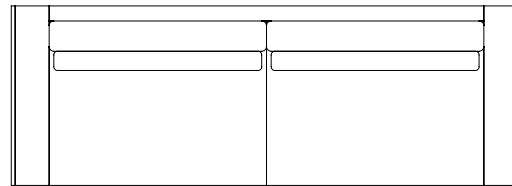

Configurações com 2 assentos e 2 braços

Módulo 176 - 2ass(68) + 2br(20) + 2alm/enc(68x45) + 2alm/rim(63x24)

Módulo 210 - 2ass(85) + 2br(20) + 2alm/enc(85x45) + 2alm/rim(80x24)

Módulo 240 - 2ass(100) + 2br(20) + 2alm/enc(100x45) + 2alm/rim(95x24)

Módulo 270 - 2ass(115) + 2br(20) + 2alm/enc(115x45) + 2alm/rim(110x24)

DESCRIPCIÓN DEL PRODUCTO

ASIENTO: FIJO - CINTURÓN ELÁSTICO + HR + D20 SUAVE + FIBRA.

RESPALDO: SUELTO - D23 HIPER + D20 SOFT + FIBRA.

ALMOHADA DECORATIVA: SUELTO - D26 ULTRACEL + FIBRA SILICONADA.

PIE: IMBUÍDA.

OPCIONAL: CARGADOR USB EN EL BRAZO (CABLE DE ALIMENTACIÓN A ENCHUFE ESTÁNDAR EN BRASIL O EE. UU.).

NOTA: PRODUCTO NO DISPONIBLE EN PIEL.

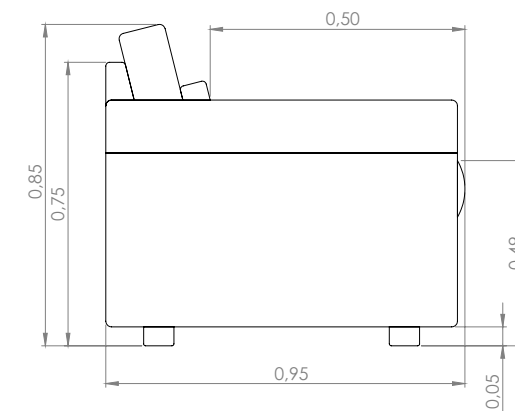

PRINCE

Design STUDIO FEELING



DESCRIÇÃO DO PRODUTO

ASSENTO: RETRÁTIL - PERCINTA + HR + D33 + D26 ULTRACEL + FIBRA.

ENCOSTO: RECLINÁVEL - D33 + D23 HIPER + D26 ULTRACEL + D20 SOFT + FIBRA.

ALMOFADA DE RIM: SOLTA - FIBRA SILICONADA

PÉ: IMBUÍDA

DETALHE COSTURA: BRAÇO - COSTURA E

LINHA DETALHE COSTURA: BRANCO (01), VERDE (02), CARAMELO (03), MARRON (04), PRETO (05), AREIA (06) OU CINZA (07)

OPCIONAIS: CARREGADOR USB NO BRAÇO (CABO DE ALIMENTAÇÃO PARA TOMADA PADRÃO DO BRASIL OU EUA).

OBSERVAÇÕES: ENCOSTO RECLINÁVEL COM 4 ESTÁGIOS.

DESCRIPTION OF PRODUCT

SEAT: RETRACTABLE - ELASTIC BELT + HR + D33 + D26 ULTRACEL + FIBER.

BACKREST: RECLINING - D33 + D23 HYPER + D26 ULTRACEL + D20 SOFT + FIBER.

DECORATIVE CUSHION: LOOSE - SILICONED FIBER

FOOT: IMBUÍDA

SEWING DETAIL: ARM - E SEWING

SEWING THREADS: WHITE (01), GREEN (02), CARAMEL (03), BROWN (04), BLACK (05), SAND (06) OR GRAY (07).

OPTIONAL: USB CHARGER IN THE ARMREST (POWER CORD TO STANDARD BRAZIL OR US OUTLET).

NOTE: RECLINING BACKREST WITH 4 STAGES.

DESCRIPCIÓN DEL PRODUCTO

ASIENTO: RETRÁCTIL - CINTURÓN ELÁSTICO + HR + D33 + D26 ULTRACEL + FIBRA.

RESPALDO: RECLINABLE - D33 + D23 HIPER + D26 ULTRACEL + D20 SOFT + FIBRA.

ALMOHADA DECORATIVA: SUELTO - FIBRA SILICONADA

PIE: IMBUÍDA

DETALLE DE LA COSTURA: BRAZO - COSTURA E

HILO DEL DETALLE DE LA COSTURA: BLANCO (01), VERDE (02), CARAMELO (03), MARRÓN (04), NEGRO (05), ARENA (06) O GRIS (07).

OPCIONAL: CARGADOR USB EN EL BRAZO (CABLE DE ALIMENTACIÓN A ENCHUFE ESTÁNDAR EN BRASIL O EE. UU.).

OBSERVACIONES: RESPALDO RECLINABLE CON 4 ETAPAS.

PRINCE

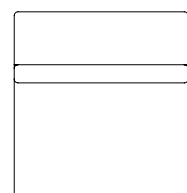

Configurações com 1 assento e sem braço

Módulo 80 - 1 ass(80) + 1 alm/rim(80x25)
Módulo 93 - 1 ass(93) + 1 alm/rim(93x25)
Módulo 104 - 1 ass(104) + 1 alm/rim(104x25)
Módulo 115 - 1 ass(115) + 1 alm/rim(115x25)

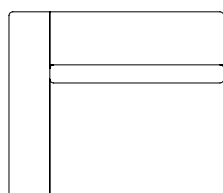

Configurações com 1 assento e 1 braço

Módulo 107 - 1 ass(80) + 1 br(27) + 1 alm/rim(80x25)
Módulo 120 - 1 ass(93) + 1 br(27) + 1 alm/rim(93x25)
Módulo 131 - 1 ass(104) + 1 br(27) + 1 alm/rim(104x25)
Módulo 142 - 1 ass(115) + 1 br(27) + 1 alm/rim(115x25)

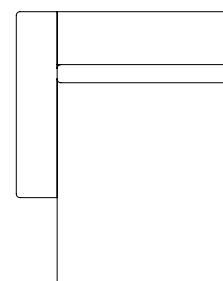

Configurações de Chaise com 1 braço

Chaise 120 - 1 ass(93) + 1 br(27) + 1 alm/rim(93x25)
Chaise 131 - 1 ass(104) + 1 br(27) + 1 alm/rim(104x25)
Chaise 142 - 1 ass(115) + 1 br(27) + 1 alm/rim(115x25)

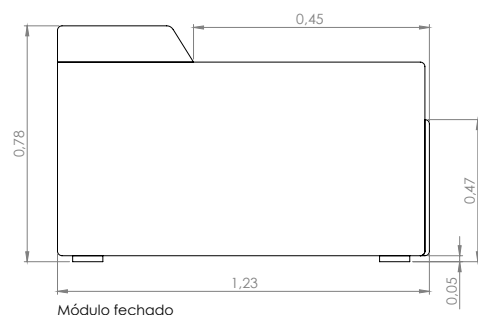

Módulo fechado

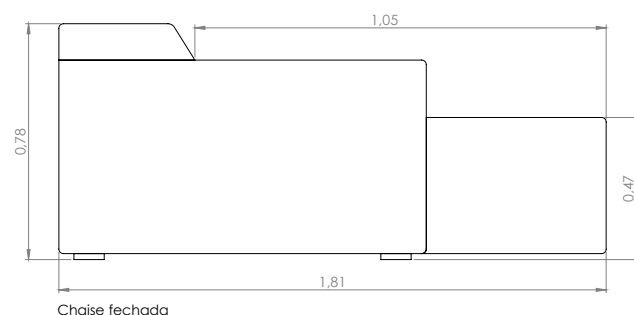

Chaise fechada

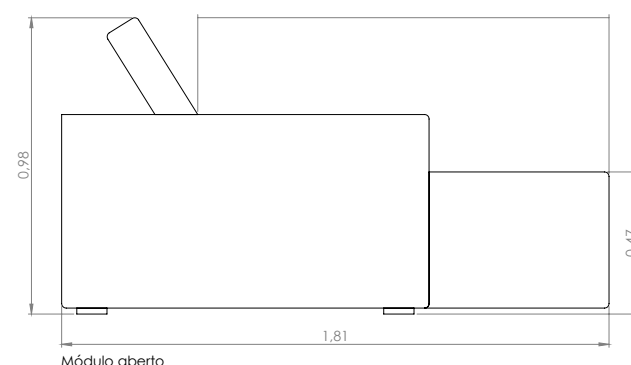

Módulo aberto

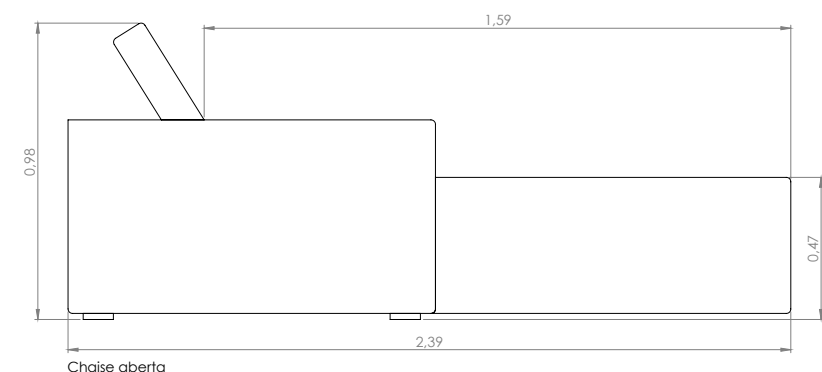

Chaise aberta



QUEBEC



Design STUDIO FEELING



DESCRIÇÃO DO PRODUTO

ASSENTO: RETRÁTIL - MOLA + D33 + D26 ULTRACEL + FIBRA.

ENCOSTO: RECLINÁVEL - D33 + D20 SOFT + FIBRA.

PÉ: IMBUÍDA.

OPCIONAIS: CARREGADOR USB NO BRAÇO (CABO DE ALIMENTAÇÃO PARA TOMADA PADRÃO DO BRASIL OU EUA).

OBSERVAÇÕES: ENCOSTO RECLINÁVEL COM 3 ESTÁGIOS.

DESCRIPTION OF PRODUCT

SEAT: RETRACTABLE - SPRING + D33 + D26 ULTRACEL + FIBER.

BACKREST: RECLINING - D33 + D20 SOFT + FIBER.

FOOT: IMBUÍDA.

OPTIONAL: USB CHARGER IN THE ARMREST (POWER CORD TO STANDARD BRAZIL OR US OUTLET).

NOTE: RECLINING BACKREST WITH 3 STAGES.

DESCRIPCIÓN DEL PRODUCTO

ASIENTO: RETRÁCTIL - RESORTE + D33 + D26 ULTRACEL + FIBRA.

RESPALDO: RECLINABLE - D33 + D20 SUAVE + FIBRA.

PIE: IMBUÍDA.

OPCIONAL: CARGADOR USB EN EL BRAZO (CABLE DE ALIMENTACIÓN A ENCHUFE ESTÁNDAR EN BRASIL O EE. UU.).

OBSERVACIONES: RESPALDO RECLINABLE CON 3 ETAPAS.

QUEBEC

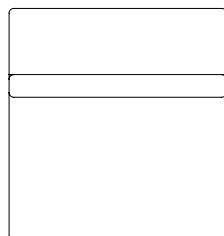

Configurações com 1 assento e sem braço

Módulo 95 - 1ass(95)

Módulo 109 - 1ass(109)

Módulo 115 - 1ass(115)

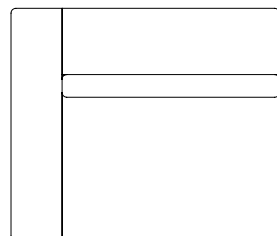

Configurações com 1 assento e 1 braço

Módulo 110 - 1ass(95) + 1br(15)

Módulo 124 - 1ass(109) + 1br(15)

Módulo 130 - 1ass(115) + 1br(15)

Módulo 118 - 1ass(95) + 1br(23)

Módulo 132 - 1ass(109) + 1br(23)

Módulo 138 - 1ass(115) + 1br(23)

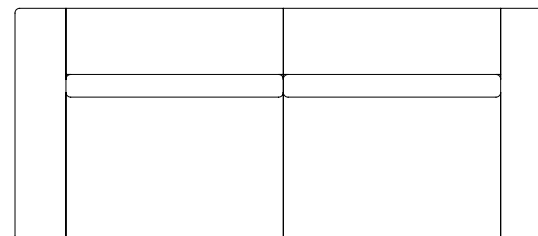

Configurações com 2 assentos e 2 braços

Módulo 220 - 2ass(95) + 2br(15)

Módulo 248 - 2ass(109) + 2br(15)

Módulo 260 - 2ass(115) + 2br(15)

Módulo 236 - 2ass(95) + 2br(23)

Módulo 264 - 2ass(109) + 2br(23)

Módulo 276 - 2ass(115) + 2br(23)

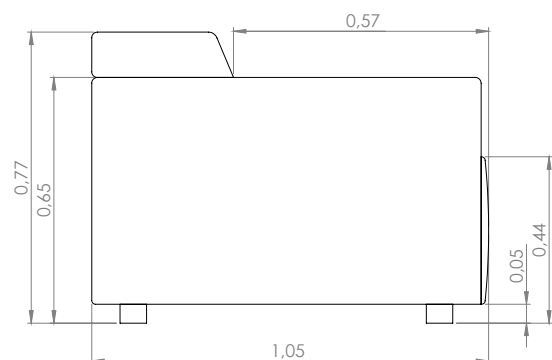

SANTORINI

Design STUDIO FEELING



DESCRIÇÃO DO PRODUTO

ASSENTO: FIXO - MOLA + HR + D33.

ENCOSTO: FIXO - D33.

BASE: PINTURA LACA - BRANCO, PRETO, FENDI OU NUDE.

TONALIZANTE - NATURAL, EBANIZADO, NOGUEIRA, LINEN, NOZES OU IMBUÍIA.

DESCRIPTION OF PRODUCT

SEAT: FIXED - SPRING + HR + D33.

BACKREST: FIXED - D33.

BASE: LACQUER PAINT - WHITE, BLACK, FENDI OR NUDE.

TONALIZER - NATURAL, EBONY, WALNUT, LINEN, WALNUT OR IMBUÍIA

DESCRIPCIÓN DEL PRODUCTO

ASIENTO: FIJO - RESORTE + HR + D33.

RESPALDO: FIJO - D33.

BASE: PINTURA DE LACA - BLANCA, NEGRA, FENDI O NUDE.

TONO - NATURAL, ÉBANO, NOGAL, LINO, NOGAL O IMBUÍIA.



SANTORINI

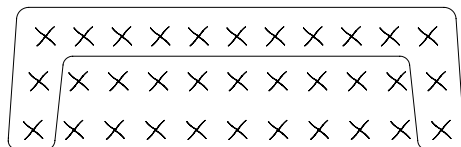

Configurações com 1 assento e 2 braços

Módulo 220 - 1ass(150) + 2br(35)

Módulo 260 - 1ass(190) + 2br(35)

Módulo 300 - 1ass(230) + 2br(35)

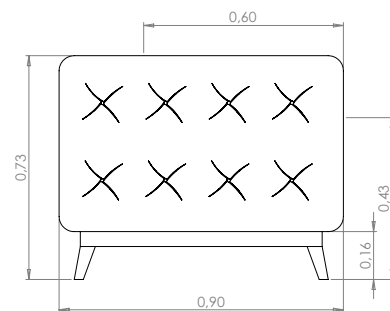

CHESTERFIELD

Design STUDIO FEELING



DESCRIÇÃO DO PRODUTO

ASSENTO: FIXO - PERCINTA + D20 SOFT.

ALMOFADA ASSENTO: SOLTO - HR + D26 ULTRACEL.

ENCOSTO: FIXO - D33.

PÉ: IMBUÍA.

DESCRIPTION OF PRODUCT

SEAT: FIXED - ELASTIC BELT + D20 SOFT.

SEAT CUSHION: LOOSE - HR + D26 ULTRACEL.

BACKREST: FIXED - D33.

FOOT: IMBUÍA.

DESCRIPCIÓN DEL PRODUCTO

ASIENTO: FIJO - CINTURÓN ELÁSTICO + D20 SUAVE.

ALMOHADA DE ASIENTO: SUELTO - HR + D26 ULTRACEL.

RESPALDO: FIJO - HR + D20 SUAVE + FIBRA.

PIES: IMBUÍA.

OBSERVACIONES: PRODUCTO NO DISPONIBLE EN PIEL.

CHESTERFIELD

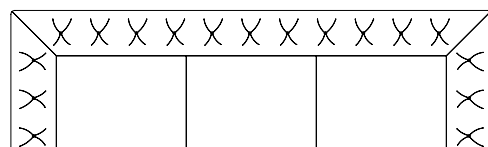

Configuração com 3 assentos e 2 braços

Módulo 318 - 3ass(85) + 2br(31,5)

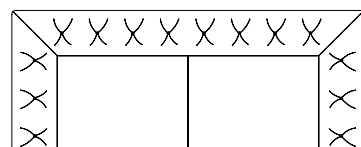

Configurações com 2 assentos e 2 braços

Módulo 193 - 2ass(65) + 2br(31,5)

Módulo 233 - 2ass(85) + 2br(31,5)

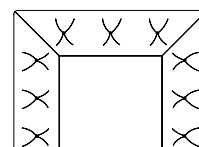

Configuração de Poltrona

Poltrona 128 - 1ass(65) + 2br(31,5)

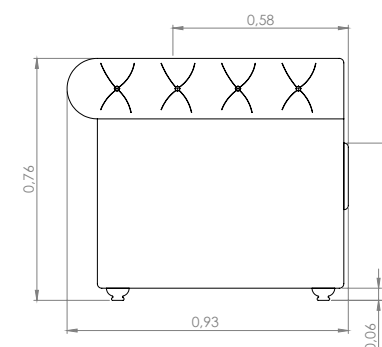

P O L T R O N A S





BOTO

Design MAURICIO BOMFIM



ASSISTA O
CONCEITO
DESTE
PRODUTO

DESCRIÇÃO DO PRODUTO

ASSENTO: FIXO - PERCINTA - HR + ULTRACEL + FIBRA

BRAÇO: FIXO - D33 + FIBRA

ROLINHO: FIXO - D33 + FIBRA

PÉ: PINTURA ELETROSTÁTICA - CHUMBO, MARROM OU BLACK.

OBSERVAÇÕES: A POLTRONA SERÁ COMERCIALIZADA SOMENTE NOS TECIDOS: 964, 551100, 551127, 551153, 851131, 951030, 951031, 965027, 965028, 965030, 965029, 965040, 965041, 965042, 971042. PRODUTO INDISPONÍVEL EM COURO, TECIDO FORNECIDO E MEDIDAS ESPECIAIS. PARTE DOS BRAÇOS SOBREPÕEM O ASSENTO.

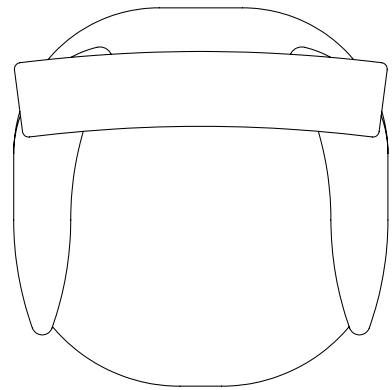

Configuração de Poltrona

Poltrona 90 - 1ass(64) + 2br(13) + 1rol(83x23)

DESCRIPTION OF PRODUCT

SEAT: FIXED - ELASTIC BELT - HR + ULTRACEL + FIBER

ARM: FIXED - D33 + FIBER

ROLL CUSHION: FIXED - D33 + FIBER

FOOT: ELECTROSTATIC PAINTING - LEAD, BROWN OR BLACK.

NOTE: THE ARMCHAIR WILL BE COMMERCIALIZED ONLY IN FABRICS: 964, 551100, 551127, 551153, 851131, 951030, 951031, 965027, 965028, 965030, 965029, 965040, 965041, 965042, 971042. PRODUCT NOT AVAILABLE IN LEATHER, FABRIC SUPPLIED BY THE CUSTOMER OR SPECIAL MEASURES. PART OF THE ARMS OVERLAP THE SEAT.

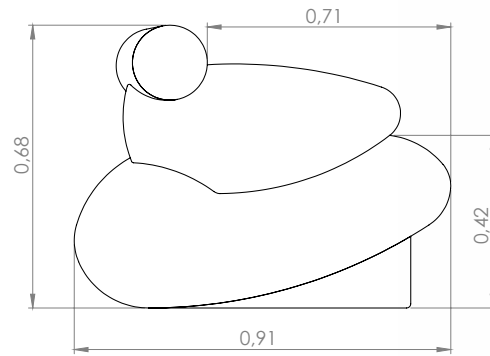

DESCRIPCIÓN DEL PRODUCTO

ASIENTO: FIJO - CINTURÓN ELÁSTICO - HR + ULTRACEL + FIBRA

BRAZO: FIJO - D33 + FIBRA

ALMOHADA ROLLITO: FIJO - D33 + FIBRA

PIE: PINTURA ELECTROSTÁTICA - PLOMO, MARRÓN O NEGRO.

OBSERVACIONES: EL SILLÓN SE COMERCIALIZARÁ ÚNICAMENTE EN LAS TELAS: 964, 551100, 551127, 551153, 851131, 951030, 951031, 965027, 965028, 965030, 965029, 965040, 965041, 965042, 971042. PRODUCTO NO DISPONIBLE EN PIEL, TELA SUMINISTRADA Y TAMAÑOS ESPECIALES. PARTE DE LOS BRAZOS SE SUPERPONEN AL ASIENTO.



FÁBULA

Design MAURICIO BOMFIM



ASSISTA O
CONCEITO
DESTE
PRODUTO

DESCRIÇÃO DO PRODUTO

ASSENTO: FIXO - HR + ULTRACEL + FIBRA

BRAÇO: AÇO INOX POLIDO - PINTURA ELETROSTÁTICA: CHUMBO, MARROM OU BLACK.

ILHÓS: AÇO INOX POLIDO - PINTURA ELETROSTÁTICA: CHUMBO, MARROM OU BLACK.

OPCIONAIS: BASE FIXA OU GIRATÓRIA.

OBSERVAÇÕES: A POLTRONA SERÁ COMERCIALIZADA SOMENTE

NOS TECIDOS: 964, 551100, 551127, 551153, 851131, 951030, 951031, 965027, 965028, 965030, 965029, 965040, 965041, 965042, 971042.

PRODUTO INDISPONÍVEL EM COURO, TECIDO FORNECIDO E MEDIDAS ESPECIAIS.

DESCRIPTION OF PRODUCT

SEAT: FIXED - HR + ULTRACEL + FIBER

ARMREST: POLISHED STAINLESS STEEL - ELECTROSTATIC PAINTING: LEAD, BROWN OR BLACK.

EYELETS: POLISHED STAINLESS STEEL - ELECTROSTATIC PAINT: LEAD, BROWN OR BLACK.

OPTIONAL: FIXED OR ROTATING BASE.

NOTES: THE ARMCHAIR WILL BE COMMERCIALIZED ONLY IN

FABRICS: 964, 551100, 551127, 551153, 851131, 951030, 951031, 965027, 965028, 965030, 965029, 965040, 965041, 965042, 971042.

PRODUCT UNAVAILABLE IN LEATHER, FABRIC SUPPLIED AND SPECIAL MEASUREMENTS.

DESCRIPCIÓN DEL PRODUCTO

ASIENTO: FIJO - HR + ULTRACEL + FIBRA

BRAZO: ACERO INOXIDABLE PULIDO - PINTURA ELECTROSTÁTICA: PLOMO, MARRÓN O NEGRO.

OJALES: ACERO INOXIDABLE PULIDO - PINTURA ELECTROSTÁTICA: PLOMO, MARRÓN O NEGRO.

OPCIONAL: BASE FIJA O GIRATORIA.

OBSERVACIONES: EL SILLÓN SE COMERCIALIZARÁ ÚNICAMENTE

EN LAS TELAS: 964, 551100, 551127, 551153, 851131, 951030, 951031, 965027, 965028, 965030, 965029, 965040, 965041, 965042, 971042.

PRODUCTO NO DISPONIBLE EN PIEL, TELA SUMINISTRADA Y MEDIDAS ESPECIALES.

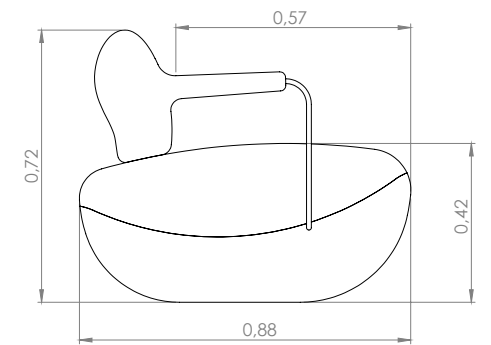
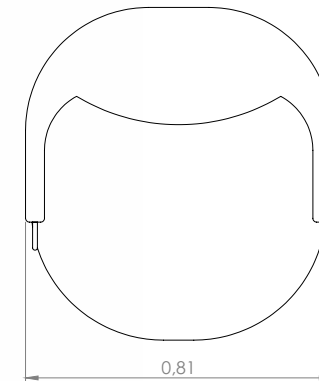

Configuração de Poltrona

Poltrona fixa 81 - 1ass(69) + 2br(6)

Poltrona gir 81 - 1ass(69) + 2br(6)

TANNAT

Design MAURICIO BOMFIM



ASSISTA O
CONCEITO
DESTE
PRODUTO

DESCRIÇÃO DO PRODUTO

ASSENTO: FIXO - HR + FIBRA

BRAÇO: AÇO INOX POLIDO - PINTURA ELETROSTÁTICA: CHUMBO, MARROM OU BLACK.

DETALHE: AÇO INOX POLIDO - PINTURA ELETROSTÁTICA: CHUMBO, MARROM OU BLACK.

PINO SUPORTE: AÇO INOX POLIDO - PINTURA ELETROSTÁTICA: CHUMBO, MARROM OU BLACK.

ILHÓS: AÇO INOX POLIDO - PINTURA ELETROSTÁTICA: CHUMBO, MARROM OU BLACK.

BASE GIRATÓRIA: AÇO INOX POLIDO - PINTURA ELETROSTÁTICA: CHUMBO, MARROM OU BLACK.

CORDA: CORES: AREIA, BRANCO, CINZA, PRETO

OBSERVAÇÕES: OS PRODUTOS SERÃO COMERCIALIZADOS SOMENTE NOS TECIDOS: 964, 551100, 551127, 551153, 851131, 951030, 951031, 965027, 965028, 965030, 965029, 965040, 965041, 965042, 971042.

PRODUTO INDISPONÍVEL EM COURO, TECIDO FORNECIDO E MEDIDAS ESPECIAIS.

DESCRIPCIÓN DEL PRODUCTO

ASIENTO: FIJO - HR + FIBRA

BRAZOS: ACERO INOXIDABLE PULIDO - PINTURA ELECTROSTÁTICA: PLOMO, MARRÓN O NEGRO.

DETALLE: ACERO INOXIDABLE PULIDO - PINTURA ELECTROSTÁTICA: PLOMO, MARRÓN O NEGRO.

CLAVIJA DE SOPORTE: ACERO INOXIDABLE PULIDO - PINTURA ELECTROSTÁTICA: PLOMO, MARRÓN O NEGRO.

OJALES: ACERO INOXIDABLE PULIDO - PINTURA ELECTROSTÁTICA: PLOMO, MARRÓN O NEGRO.

BASE GIRATORIA: ACERO INOXIDABLE PULIDO - PINTURA ELECTROSTÁTICA: PLOMO, MARRÓN O NEGRO.

CUERDA: COLORES: ARENA, BLANCO, GRIS, NEGRO

OBSERVACIONES: LOS PRODUCTOS SE VENDERÁN ÚNICAMENTE EN LAS TELAS: 964, 551100, 551127, 551153, 851131, 951030, 951031, 965027, 965028, 965030, 965029, 965040, 965041, 965042, 971042.

PRODUCTO NO DISPONIBLE EN PIEL, TELA SUMINISTRADA Y TAMAÑOS ESPECIALES.

DESCRIPTION OF PRODUCT

SEAT: FIXED - HR + FIBER

ARMREST: POLISHED STAINLESS STEEL - ELECTROSTATIC PAINTING: LEAD, BROWN OR BLACK.

DETAIL: POLISHED STAINLESS STEEL - ELECTROSTATIC PAINT: LEAD, BROWN OR BLACK.

SUPPORT PIN: POLISHED STAINLESS STEEL - ELECTROSTATIC PAINT: LEAD, BROWN OR BLACK.

EYELETS: POLISHED STAINLESS STEEL - ELECTROSTATIC PAINT: LEAD, BROWN OR BLACK.

ROTATING BASE: POLISHED STAINLESS STEEL - ELECTROSTATIC PAINT: LEAD, BROWN OR BLACK.

ROPE: COLORS: SAND, WHITE, GRAY, BLACK

NOTES: PRODUCTS WILL BE SOLD ONLY IN FABRICS: 964, 551100, 551127, 551153, 851131, 951030, 951031, 965027, 965028, 965030, 965029, 965040, 965041, 965042, 971042.

PRODUCT UNAVAILABLE IN LEATHER, FABRIC SUPPLIED AND SPECIAL SIZES.

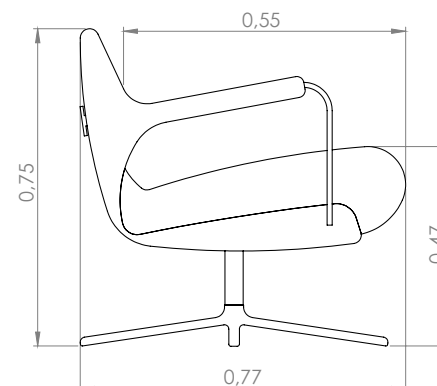
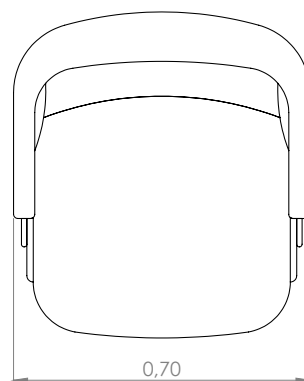

Configuração de Poltrona

Poltrona gir 70 - 1ass(60) + 2br(5)

Configuração de Balanço

Balanço 70 - 1ass(60) + 2br(5)



DIAMANTINA

Design MAURICIO BOMFIM



ASSISTA O
CONCEITO
DESTE
PRODUTO

DESCRIÇÃO DO PRODUTO

ASSENTO: FIXO - HR + D26 ULTRACEL + FIBRA.

ENCOSTO: FIXO - HR + FIBRA.

BASE: PINTURA ELETROSTÁTICA - CHUMBO, MARROM OU BLACK.
LÂMINA NATURAL - CARVALHO NATURAL, CARVALHO EBANIZADO, CARVALHO LINEN OU NOGUEIRA.

OBSERVAÇÕES: A BASE LAMINADA TEM COMO PADRÃO AS BORDAS PINTADAS.
PRODUTO INDISPONÍVEL EM MEDIDAS ESPECIAIS.

DESCRIPTION OF PRODUCT

SEAT: FIXED - HR + D26 ULTRACEL + FIBER.

BACKREST: FIXED - HR + FIBER.

BASE: ELECTROSTATIC PAINTING - LEAD, BROWN OR BLACK.
NATURAL VENEER - NATURAL OAK, EBONIZED OAK, OAK LINEN OR WALNUT.

NOTE: THE LAMINATED BASE HAS PAINTED EDGES AS STANDARD.
PRODUCT UNAVAILABLE IN SPECIAL MEASURES.

DESCRIPCIÓN DEL PRODUCTO

ASIENTO: FIJO - HR + D26 ULTRACEL + FIBRA.

RESPALDO: FIJO - HR + FIBRA.

BASE: PINTURA ELECTROSTÁTICA - PLOMO, MARRÓN O NEGRO.
CHAPA NATURAL - ROBLE NATURAL, ROBLE EBANIZADO, ROBLE LINO O NOGAL.

OBSERVACIONES: LA BASE LAMINADA TIENE LOS BORDES PINTADOS POR DEFECTO. PRODUCTO NO DISPONIBLE EN MEDIDAS ESPECIALES.

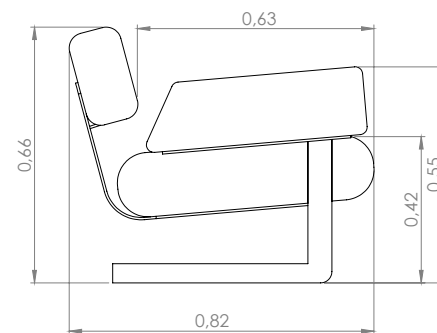
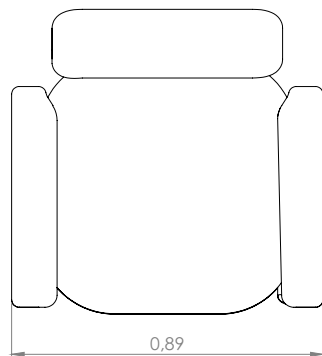

Configuração de Poltrona

Poltrona 89 - 1ass(61) + 2br(14)

JAÍBA

Design MAURICIO BOMFIM



ASSISTA O
CONCEITO
DESTE
PRODUTO

DESCRIÇÃO DO PRODUTO

ASSENTO: FIXO - PERCINTA + HR + D33 + D26 ULTRACEL + FIBRA.

ENCOSTO: FIXO - HR + FIBRA.

ALMOFADA DE RIM: FIXA - HR + FIBRA.

PÉ/BASE: PINTURA ELETROSTÁTICA - CHUMBO, MARROM OU BLACK.

OBSERVAÇÕES: ALMOFADA DE RIM É FIXA NO ENCOSTO.

A POLTRONA SERÁ COMERCIALIZADA SOMENTE NOS
TECIDOS 551100, 551101, 551102, 551123, 551127, 651113, 651115,
951030, 951031, 951032, 965027, 965028, 965029 E 965030.

PRODUTO INDISPONÍVEL EM COURO, TECIDO FORNECIDO E MEDIDAS
ESPECIAIS.

DESCRIPTION OF PRODUCT

SEAT: FIXED - ELASTIC BELT + HR + D33 + D26 ULTRACEL + FIBER.

BACKREST: FIXED - HR + FIBER.

LUMBAR CUSHION: FIXED - HR + FIBER.

FOOT/BASE: ELECTROSTATIC PAINTING - LEAD, BROWN OR BLACK.

NOTE: LUMBAR CUSHION IS FIXED ON THE BACKREST.

THE ARMCHAIR WILL BE SOLD ONLY IN FABRICS 551100,
551101, 55111102, 551123, 551127, 651113, 651115, 951030,
951031, 951032, 965027, 965028, 965029 AND 965030.

PRODUCT NOT AVAILABLE IN LEATHER, CLIENT'S FABRICS AND SPECIAL
MEASURES.

DESCRIPCIÓN DEL PRODUCTO

ASIENTO: FIJO - CINTURÓN ELÁSTICO + HR + D33 + D26 ULTRACEL + FIBRA.

RESPALDO: FIJO - HR + FIBRA.

ALMOHADA DECORATIVA: FIJO - HR + FIBRA.

PIE/BASE: PINTURA ELECTROSTÁTICA - PLOMO, MARRÓN O NEGRO.

OBSERVACIONES: LA ALMOHADA
DECORATIVA SE FIJA EN EL RESPALDO.

EL SILLÓN SE VENDERÁ ÚNICAMENTE EN LOS TEJIDOS

551100, 551101, 55111102, 551123, 551127, 651113, 651115,
951030, 951031, 951032, 965027, 965028, 965029 Y 965030.

PRODUCTO NO DISPONIBLE EN PIEL, TELA SUMINISTRADA Y TAMAÑOS
ESPECIALES.

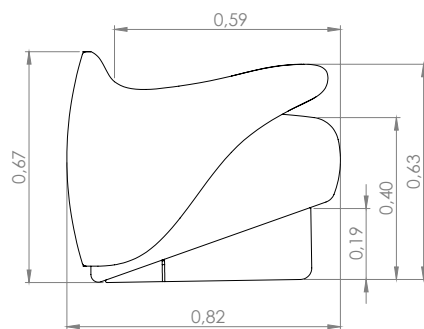
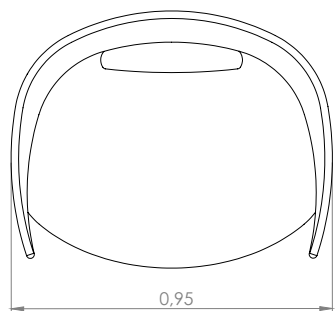

Configuração de Poltrona

Poltrona 95 - 1ass(81) + 2br(7) + 1alm/rim(45x23)

OPUS

Design STUDIO FEELING



DESCRIÇÃO DO PRODUTO

ALMOFADA DE ASSENTO/ENCOSTO POLTRONA: FIXA - HR + D20 SOFT + FIBRA + PENA DE GANSO.

ALMOFADA DE ASSENTO PUFF: FIXA - PENA DE GANSO + D33 + FIBRA.

CONCHA: REVESTIDA - COURO OU TECIDO.

PÉ/BASE GIRATORIA: LÂMINA NATURAL - CARVALHO NATURAL, CARVALHO EBANIZADO, CARVALHO LINEN OU NOGUEIRA.

PÉ/BASE FIXA: PINTURA ELETROSTÁTICA - CHUMBO, MARROM OU BLACK.

OPCIONAIS: BASE FIXA OU GIRATÓRIA.

OBSERVAÇÕES: REVESTIMENTO INTERNO DA CONCHA INDISPONÍVEL EM COURO. AS DIMENSÕES GERAIS NÃO SOFREM ALTERAÇÕES NAS CONFIGURAÇÕES FIXA OU GIRATÓRIA. PRODUTO INDISPONÍVEL EM MEDIDAS ESPECIAIS.

DESCRIPTION OF PRODUCT

ARMCHAIR SEAT/BACKREST CUSHION: FIXED - HR + D20 SOFT + FIBER + GOOSE DOWN.

PUFF SEAT CUSHION: FIXED - GOOSE FEATHER + D33 + FIBER.

SHELL: COVERED - LEATHER OR FABRIC.

ROTATING BASE/FOOT: NATURAL VENEER - NATURAL OAK, EBONIZED OAK, OAK LINEN OR WALNUT.

FIXED BASE/FOOT: ELECTROSTATIC PAINTING - LEAD, BROWN OR BLACK.

OPTIONAL: FIXED OR ROTATING BASE.

NOTE: INTERNAL SHELL COVERING NOT AVAILABLE IN LEATHER. THE GENERAL DIMENSIONS DO NOT CHANGE TO THE FIXED OR ROTATING CONFIGURATIONS. PRODUCT UNAVAILABLE IN SPECIAL MEASURES

DESCRIPCIÓN DEL PRODUCTO

ALMOHADA DE ASIENTO/RESPALDO DEL SILLÓN: FIJO - HR + D20 SOFT + FIBRA + PLUMA DE OCA.

ALMOHADA DE ASIENTO PUFF: FIJO - PLUMA DE OCA + D33 + FIBRA.

CARCASA: RECUBIERTA - PIEL O TELA.

BASE GIRATORIA/PIE: CHAPA NATURAL - ROBLE NATURAL, ROBLE BURILADO, ROBLE LINO O NOGAL.

BASE FIJA/PIE: PINTURA ELECTROSTÁTICA - PLOMO, MARRÓN O NEGRO.

OPCIONAL: BASE FIJA O GIRATORIA.

OBSERVACIONES: EL REVESTIMIENTO INTERIOR NO ESTÁ DISPONIBLE EN PIEL. LAS DIMENSIONES GENERALES NO CAMBIAN EN LAS CONFIGURACIONES FIJAS O GIRATORIAS. PRODUCTO NO DISPONIBLE EN MEDIDAS ESPECIALES.

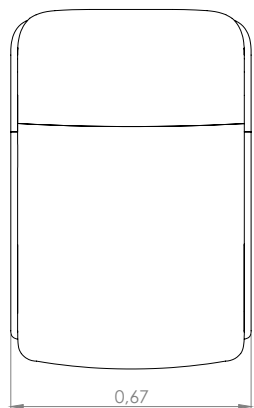

Configuração de Poltrona

Poltrona 67 - 1ass(64)

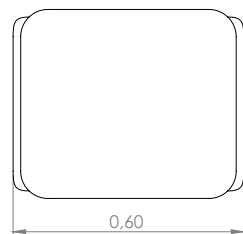

Configuração de Puff

Puff 60 - 1puff(60)

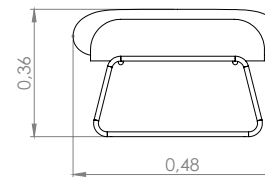
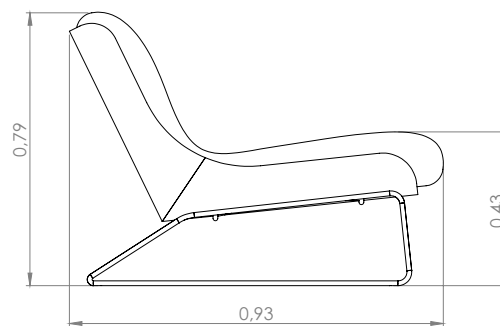

AMBURANA

Design MAURICIO BOMFIM



ASSISTA O
CONCEITO
DESTE
PRODUTO

AMBURANA

DESCRIÇÃO DO PRODUTO

ASSENTO: FIXO - MOLA + HR + D33 + FIBRA.

ENCOSTO: FIXO - HR + FIBRA.

BASE: PINTURA ELETROSTÁTICA - CHUMBO, MARROM OU BLACK.
LÂMINA NATURAL - CARVALHO NATURAL, CARVALHO EBANIZADO,
CARVALHO LINEN OU NOGUEIRA.

DETALHE: AÇO INOX POLIDO.

OBSERVAÇÕES: AS BORDAS DA BASE SERÃO SEMPRE PINTADAS.
PRODUTO INDISPONÍVEL EM MEDIDA ESPECIAL.

DESCRIPTION OF PRODUCT

SEAT: FIXED - SPRING + HR + D33 + FIBER.

BACKREST: FIXED - HR + FIBER.

BASE: ELECTROSTATIC PAINTING - LEAD, BROWN OR BLACK.
NATURAL VENEER - NATURAL OAK, EBONIZED OAK, OAK LINEN OR WALNUT.

DETAIL: POLISHED STAINLESS STEEL.

NOTE: THE EDGES OF THE BASE WILL ALWAYS BE PAINTED.
PRODUCT UNAVAILABLE IN SPECIAL MEASURES.

DESCRIPCIÓN DEL PRODUCTO

ASIENTO: FIJO - RESORTE + HR + D33 + FIBRA.

RESPALDO: FIJO - HR + FIBRA.

BASE: PINTURA ELECTROSTÁTICA - PLOMO, MARRÓN O NEGRO.
CHAPA NATURAL - ROBLE NATURAL, ROBLE EBONIZADO, ROBLE LINO O NOGAL.

DETALLE: ACERO INOXIDABLE PULIDO.

OBSERVACIONES: LOS BORDES DE LA BASE SIEMPRE ESTÁN PINTADOS.
PRODUCTO NO DISPONIBLE EN MEDIDA ESPECIAL.

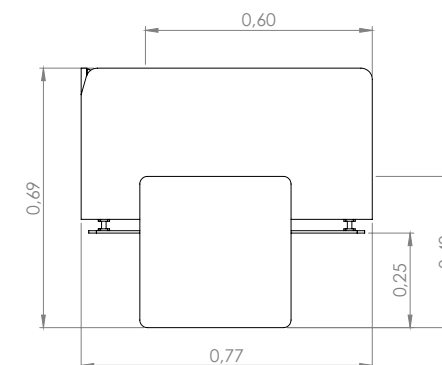
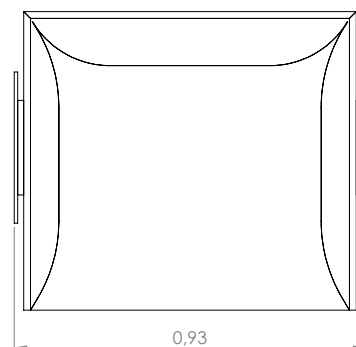

Configuração de Poltrona

Poltrona 93 - 1ass(67) + 2br(13)

BARU

Design MAURICIO BOMFIM



ASSISTA O
CONCEITO
DESTE
PRODUTO

BARU

DESCRIÇÃO DO PRODUTO

ASSENTO/ENCOSTO POLTRONA: SOLTA - HR + D20 SOFT + FIBRA + PENA DE GANSO.

ASSENTO PUFF: FIXO - PERCINTA + HR + FIBRA.

CONCHA: REVESTIDA - COURO.

BASE: PINTURA ELETROSTÁTICA - CHUMBO, MARROM OU BLACK.

OBSERVAÇÕES: O COURO ESCOLHIDO PARA REVESTIR A CONCHA SERÁ USADO NO DETALHE DO BRAÇO. A CONCHA NÃO PODERÁ SER REVESTIDA EM TECIDO, PINTADA OU LAMINADA. PRODUTO INDISPONÍVEL EM MEDIDA ESPECIAL.

DESCRIPTION OF PRODUCT

ARMCHAIR SEAT/BACKREST: LOOSE - HR + D20 SOFT + FIBER + GOOSE FEATHER.

PUFF SEAT: FIXED - ELASTIC BELT + HR + FIBER.

SHELL: COVERED - LEATHER.

BASE: ELECTROSTATIC PAINTING - LEAD, BROWN OR BLACK.

NOTE: THE SAME LEATHER CHOSEN TO COVER THE SHELL WILL BE USED IN THE ARM DETAIL. THE SHELL CANNOT BE COVERED IN FABRIC, PAINTED OR LAMINATED. PRODUCT NOT AVAILABLE IN SPECIAL MEASURES.



DESCRIPCIÓN DEL PRODUCTO

ASIENTO/RESPALDO SILLÓN: SUELTO - HR + D20 SUAVE + FIBRA + PLUMA DE OCA.

ASIENTO PUFF: FIJO - CINTURÓN ELÁSTICO + HR + FIBRA.

CARCASA: RECUBIERTA - PIEL.

BASE: PINTURA ELECTROSTÁTICA - PLOMO, MARRÓN O NEGRO.

OBSERVACIONES: LA PIEL ELEGIDA PARA REVESTIR LA CARCASA SE UTILIZARÁ EN EL DETALLE DEL BRAZO. LA CASCARA NO PUEDE ESTAR CUBIERTA DE TELA, PINTADA O LAMINADA. PRODUCTO NO DISPONIBLE EN MEDIDA ESPECIALES.ko



Configuração de Puff

Puff 75 - 1ass(65x53)

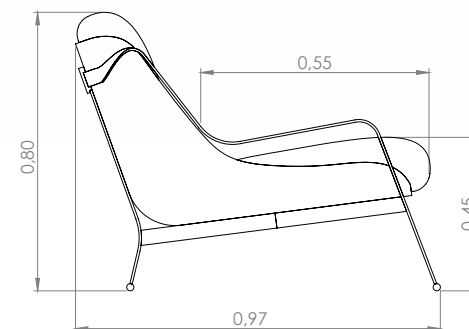

Configuração de Poltrona

Poltrona 82 - 1ass(65) + 2br(4)

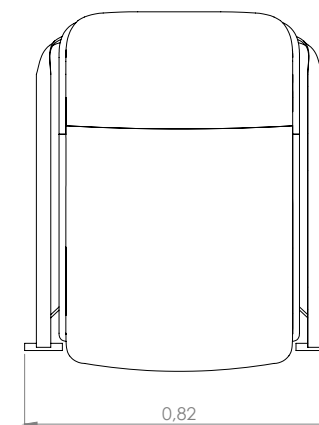
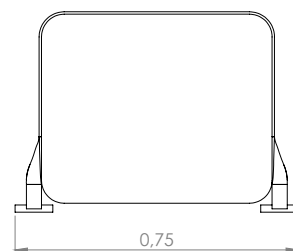

TAMBORIL

Design MAURICIO BOMFIM



ASSISTA O
CONCEITO
DESTE
PRODUTO

DESCRIÇÃO DO PRODUTO

ASSENTO: FIXO - PERCINTA + HR + D33 + FIBRA.

ENCOSTO: FIXO - HR + FIBRA.

ALMOFADA DE ENCOSTO: SOLTA - ALGODÃO.

BASE: AÇO INOX.

OBSERVAÇÕES: PRODUTO INDISPONÍVEL EM COURO.

O ASSENTO CONTÉM 90CM DE LARGURA, PORÉM APLICADO AO PRODUTO OCUPA UM ESPAÇO DE 66CM NA CONFIGURAÇÃO FINAL. PRODUTO INDISPONÍVEL EM MEDIDAS ESPECIAIS.

DESCRIPTION OF PRODUCT

SEAT: FIXED - ELASTIC BELT + HR + D33 + FIBER.

BACKREST: FIXED - HR + FIBER.

BACKREST CUSHION: LOOSE - COTTON.

BASE: STAINLESS STEEL.

NOTES: PRODUCT UNAVAILABLE IN LEATHER.

THE SEAT IS 90CM WIDE, BUT WHEN APPLIED TO THE PRODUCT IT TAKES UP 66CM OF SPACE IN THE FINAL CONFIGURATION. PRODUCT UNAVAILABLE IN SPECIAL MEASURES.

TAMBORIL

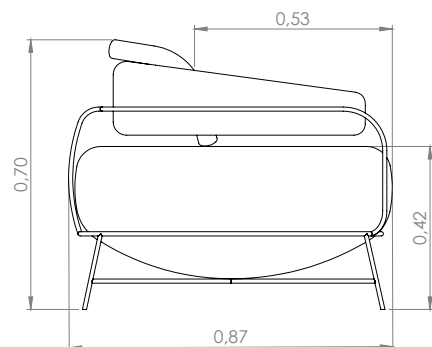
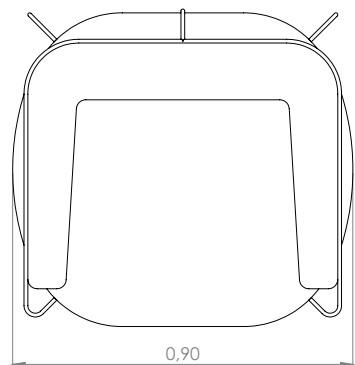

Configurações de Poltrona

Poltrona 90 - 1ass(90) + 2br(12) + 1alm/enc(50x50)

DESCRIPCIÓN DEL PRODUCTO

ASIENTO: FIJO - CINTURÓN ELÁSTICO + HR + D33 + FIBRA.

RESPALDO: FIJO - HR + FIBRA.

ALMOHADA DE RESPALDO: SUELTO - ALGODÓN.

BASE: ACERO INOXIDABLE.

OBSERVACIONES: PRODUCTO NO DISPONIBLE EN PIEL.

EL ASIENTO TIENE 90 CM DE ANCHO, PERO APLICADO AL PRODUCTO ESTE OCUPA UN ESPACIO DE 66 CM EN LA CONFIGURACIÓN FINAL. PRODUCTO NO DISPONIBLE EN MEDIDAS ESPECIALES.



PALLA CHAISE

Design STUDIO FEELING



DESCRIÇÃO DO PRODUTO

ASSENTO: FIXO - MOLA + PERCINTA + D33 + HR + FIBRA.

ALMOFADA DE ENCOSTO: SOLTA - PENA DE GANSO.

ESTRUTURA: PINTURA ELETROSTÁTICA - CHUMBO, MARROM OU BLACK.

BASE: GIRATÓRIA.

LINHA COSTURA ASSENTO: BRANCO (01), VERDE (02), CAMELO(03), MARROM(04), PRETO(05), AREIA(06), CINZA(07).

OBSERVAÇÕES: NÃO É POSSÍVEL FAZER AS TIRAS DO ENCOSTO EM TECIDO.
PRODUTO INDISPONÍVEL EM MEDIDAS ESPECIAIS.

DESCRIPTION OF PRODUCT

SEAT: FIXED - SPRING + ELASTIC BELT + D33 + HR + FIBER.

BACKREST CUSHION: LOOSE - GOOSE FEATHER.

FRAME: ELECTROSTATIC PAINTING - LEAD, BROWN OR BLACK.

BASE: ROTATING.

SEAT COVER: WHITE (01), GREEN (02), CAMEL (03), BROWN (04), BLACK (05), SAND (06), GRAY (07).

NOTE: IT IS NOT POSSIBLE TO MAKE THE BACKREST STRAPS IN FABRIC.
PRODUCT UNAVAILABLE IN SPECIAL MEASURES.

DESCRIPCIÓN DEL PRODUCTO

ASIENTO: FIJO - RESORTE + CINTURÓN ELÁSTICO + D33 + HR + FIBRA.

ALMOHADA DE RESPALDO: SUELTO - PLUMA DE OCA.

ESTRUCTURA: PINTURA ELECTROSTÁTICA - PLOMO, MARRÓN O NEGRO.

BASE: GIRATORIA.

FUNDA DE ASIENTO: BLANCO (01), VERDE (02), CAMELO (03), MARRÓN (04), NEGRO (05), ARENA (06), GRIS (07).

OBSERVACIONES: NO ES POSIBLE HACER LAS CORREAS DEL RESPALDO EN TELA. PRODUCTO NO DISPONIBLE EN MEDIDAS ESPECIALES.

CHAISE PALLA

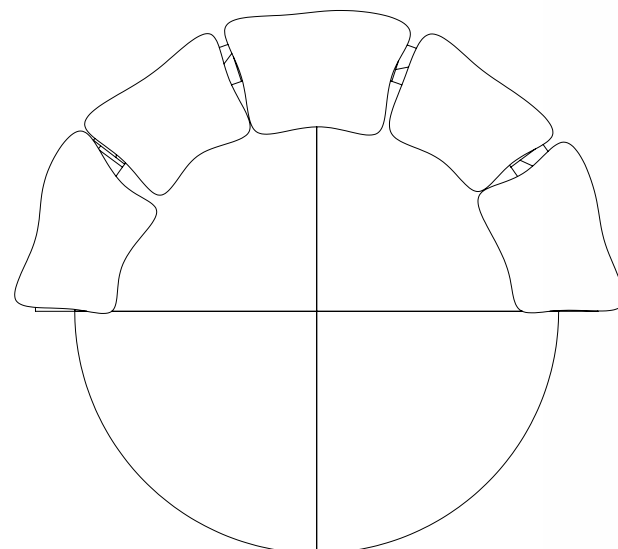
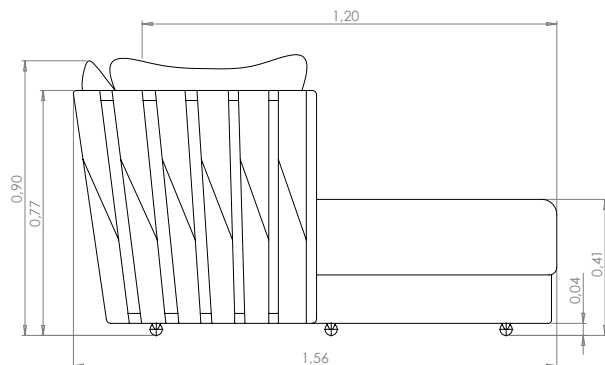

Configurações de Chaise

Chaise 166 - 1ass(140) + 2br(13) + 5alm/enc(60x50)

Chaise 186 - 1ass(160) + 2br(13) + 5alm/enc(60x50)



WINDING

Design MAURICIO BOMFIM



ASSISTA O
CONCEITO
DESTE
PRODUTO

DESCRIÇÃO DO PRODUTO

ASSENTO: FIXO - PERCINTA + HR + D33 + FIBRA.

ENCOSTO: FIXO - D20 SOFT + FIBRA.

ALMOFADA DECORATIVA: SOLTA - D23 HIPER + FIBRA.

BASE: PINTURA ELETROSTÁTICA - CHUMBO, MARROM OU BLACK.

LÂMINA NATURAL - CARVALHO NATURAL, CARVALHO EBANIZADO, CARVALHO LINEN OU NOGUEIRA.

REVESTIDA - COURO.

OPCIONAIS: BASE FIXA OU GIRATÓRIA.

OBSERVAÇÕES: O ACABAMENTO DA BASE EM LÂMINA NATURAL CONTÉM AS BORDAS PINTADAS.

PRODUTO INDISPONÍVEL EM MEDIDAS ESPECIAIS.

DESCRIPTION OF PRODUCT

SEAT: FIXED - ELASTIC BELT + HR + D33 + FIBER.

BACKREST: FIXED - D20 SOFT + FIBER.

DECORATIVE CUSHION: LOOSE - D23 HYPER + FIBER.

BASE: ELECTROSTATIC PAINTING - LEAD, BROWN OR BLACK.

NATURAL VENEER - NATURAL OAK, EBONIZED OAK, OAK LINEN OR WALNUT.

COVERED - LEATHER.

OPTIONAL: FIXED OR ROTATING BASE.

NOTE: THE BASE FINISHING IN NATURAL VENEER HAS PAINTED EDGES.

PRODUCT UNAVAILABLE IN SPECIAL MEASURES.

DESCRIPCIÓN DEL PRODUCTO

ASIENTO: FIJO - CINTURÓN ELÁSTICO + HR + D33 + FIBRA.

RESPALDO: FIJO - D20 SUAVE + FIBRA.

ALMOHADA DECORATIVA: SUELTO - D23 HIPER + FIBRA.

BASE: PINTURA ELECTROSTÁTICA - PLOMO, MARRÓN O NEGRO.

CHAPA NATURAL - ROBLE NATURAL, ROBLE EBONIZADO, ROBLE LINO O NOGAL.

REVESTIMIENTO - PIEL.

OPCIONAL: BASE FIJA O GIRATORIA.

OBSERVACIONES: EL ACABADO DE LA BASE DE CHAPA NATURAL CONTIENE BORDES PINTADOS.

PRODUCTO NO DISPONIBLE EN MEDIDAS ESPECIALES.

WINDING

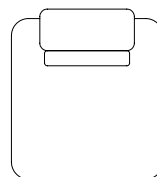

Configuração de Poltrona

Poltrona 80 - 1 ass(80) + 1 alm/dec(50x25)

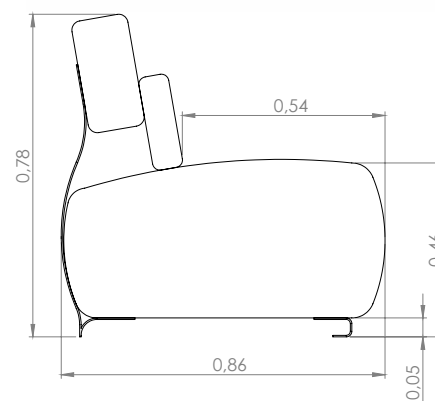

WINDING CHAISE

Design MAURICIO BOMFIM



ASSISTA O
CONCEITO
DESTE
PRODUTO

DESCRIÇÃO DO PRODUTO

ASSENTO: FIXO - PERCINTA + D33 + FIBRA.

ENCOSTO: FIXO - D20 SOFT + FIBRA.

BASE: PINTURA ELETROSTÁTICA - CHUMBO, MARROM OU BLACK.

LÂMINA NATURAL - CARVALHO NATURAL, CARVALHO EBANIZADO, CARVALHO LINEN OU NOGUEIRA.

REVESTIDA - COURO.

OBSERVAÇÕES: NAS OPÇÕES DE ACABAMENTO EM LÂMINA NATURAL, AS BORDAS DA BASE SÃO PINTADAS.

A OPÇÃO DE BASE REVESTIDA EM COURO, POSSUI UMA COSTURA DIFERENCIADA NO FECHAMENTO DA CAPA. PRODUTO INDISPONÍVEL EM MEDIDAS ESPECIAIS.

DESCRIPTION OF PRODUCT

SEAT: FIXED – ELASTIC BELT + D33 + FIBER.

BACKREST: FIXED - D20 SOFT + FIBER.

BASE: ELECTROSTATIC PAINTING – LEAD, BROWN OR BLACK.

NATURAL VENEER - NATURAL OAK, EBONIZED OAK, OAK LINEN OR WALNUT.

COATED - LEATHER.

NOTES: ON THE NATURAL VENEER FINISH OPTIONS, THE EDGES OF THE BASE ARE PAINTED.

THE LEATHER-COVERED BASE OPTION HAS A DIFFERENTIATED SEAM ON THE COVER CLOSING.

PRODUCT UNAVAILABLE IN SPECIAL MEASURES.

DESCRIPCIÓN DEL PRODUCTO

ASIENTO: FIJO – CINTURÓN ELÁSTICO + D33 + FIBRA.

RESPALDO: FIJO - D20 SUAVE + FIBRA.

BASE: PINTURA ELECTROSTÁTICA – PLOMO, MARRÓN O NEGRO.

CHAPA NATURAL - ROBLE NATURAL, ROBLE EBONIZADO, ROBLE LINO O NOGAL. REVESTIMIENTO - PIEL.

OBSERVACIONES: EN LAS OPCIONES DE ACABADO DE CHAPA NATURAL, LOS BORDES DE LA BASE ESTÁN PINTADOS.

LA OPCIÓN DE BASE REVESTIDA EN PIEL, TIENE UNA COSTURA DISTINTA EN EL CIERRE DE LA TAPA.

PRODUCTO NO DISPONIBLE EN TALLAS ESPECIALES.

WINDING CHAISE

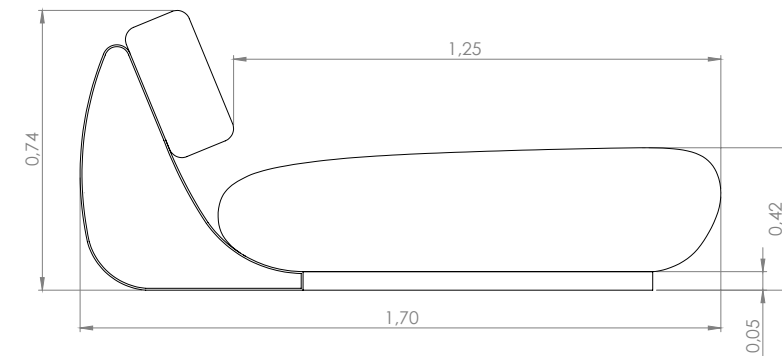
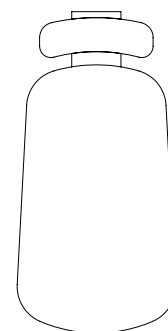

Configuração de Chaise

Chaise 80 - 1 ass(80)

CLOUD

Design MAURICIO BOMFIM



DESCRIÇÃO DO PRODUTO

ASSENTO: FIXO - PERCINTA + HR + D33 + FIBRA.

ENCOSTO: FIXO - D20 SOFT + FIBRA.

PÉ: PINTURA ELETROSTÁTICA - CHUMBO, MARROM OU BLACK. LÂMINA NATURAL - CARVALHO NATURAL, CARVALHO EBANIZADO, CARVALHO LINEN OU NOGUEIRA.

OBSERVAÇÕES: AS BORDAS DOS PÉS SEMPRE SERÃO PINTADAS.
PRODUTO INDISPONÍVEL EM MEDIDAS ESPECIAIS.

DESCRIPTION OF PRODUCT

SEAT: FIXED - ELASTIC BELT + HR + D33 + FIBER.

BACKREST: FIXED - D20 SOFT + FIBER.

FOOT: ELECTROSTATIC PAINTING - LEAD, BROWN OR BLACK.
NATURAL VENEER - NATURAL OAK, EBONIZED OAK, OAK LINEN OR WALNUT.

NOTE: THE EDGES OF THE FEET WILL ALWAYS BE PAINTED.

PRODUCT UNAVAILABLE IN SPECIAL MEASURES.

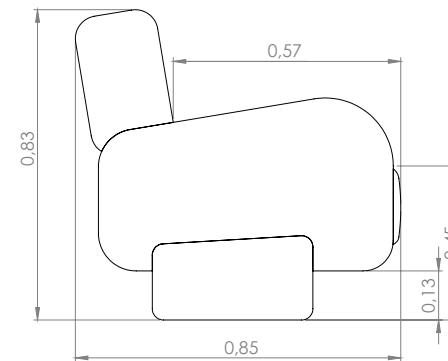
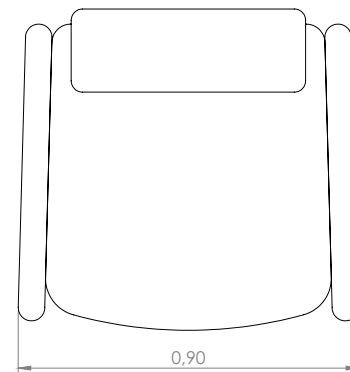

Configuração de Poltrona

Poltrona 90 - 1 ass(76) + 2br(7)

DESCRIPCIÓN DEL PRODUCTO

ASIENTO: FIJO - CINTURÓN ELÁSTICO + HR + D33 + FIBRA.

RESPALDO: FIJO - D20 SUAVE + FIBRA.

PIE: PINTURA ELECTROSTÁTICA - PLOMO, MARRÓN O NEGRO.

CHAPA NATURAL - ROBLE NATURAL, ROBLE EBANIZADO, ROBLE LINO O NOGAL.

OBSERVACIONES: LOS BORDES DE LOS PIES SIEMPRE ESTARÁN PINTADOS.

PRODUCTO NO DISPONIBLE EN MEDIDAS ESPECIALES.

CLOUD



HUG

Design MAURICIO BOMFIM



DESCRIÇÃO DO PRODUTO

ASSENTO: FIXO - PERCINTA + HR + D33 + D26 ULTRACEL + FIBRA.

ENCOSTO: FIXO - D33 + D20 SOFT.

ALMOFADA DE ENCOSTO: SOLTA - D23 + D26 ULTRACEL + FIBRA.

PÉ: PINTURA ELETROSTÁTICA - CHUMBO, MARROM OU BLACK.

DESCRIPTION OF PRODUCT

SEAT: FIXED - ELASTIC BELT + HR + D33 + D26 ULTRACEL + FIBER.

BACKREST: FIXED - D33 + D20 SOFT.

BACKREST CUSHION: LOOSE - D23 + D26 ULTRACEL + FIBER.

FOOT: ELECTROSTATIC PAINTING - LEAD, BROWN OR BLACK.

DESCRIPCIÓN DEL PRODUCTO

ASIENTO: FIJO - CINTURÓN ELÁSTICO + HR + D33 + D26 ULTRACEL + FIBRA.

RESPALDO: FIJO - D33 + D20 SUAVE.

ALMOHADA DE RESPALDO: SUELTO - D23 + D26 ULTRACEL + FIBRA.

PIE: PINTURA ELECTROSTÁTICA - PLOMO, MARRÓN O NEGRO.

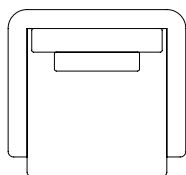

Configuração de Poltrona

Poltrona 94 - 1 ass(74) + 2 br(10) + 1 alm/enc(75x45) + 1 alm/rim(50x30)

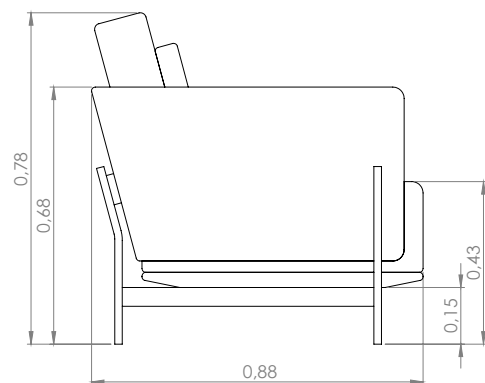

HUG



BREEZE

Design STUDIO FEELING



DESCRIÇÃO DO PRODUTO

ASSENTO: FIXO - PERCINTA + HR + D20 SOFT + D33 + FIBRA.

ENCOSTO: FIXO - HR + D20 SOFT + FIBRA.

PÉS: PINTURA ELETROSTÁTICA - CHUMBO, MARROM OU BLACK.

DETALHE: COURO, RECOURO OU TECIDO.

DETALHE COSTURA: DETALHE - COSTURA G

LINHA DETALHE COSTURA: BRANCO (01), VERDE (02), CAMELO (03), MARROM (04), PRETO (05), AREIA (06) OU CINZA (07).

OBSERVAÇÃO: PRODUTO INDISPONÍVEL EM MEDIDAS ESPECIAIS.

DESCRIPCIÓN DEL PRODUCTO

SEAT: FIXED - ELASTIC BELT + HR + D20 SOFT + D33 + FIBER.

BACKREST: FIXED - HR + D20 SOFT + FIBER.

FOOT: ELECTROSTATIC PAINTING - LEAD, BROWN OR BLACK.

DETAIL: LEATHER, LEATHER, LEATHER FIBERS OR FABRIC.

SEWING DETAIL: DETAIL - SEWING G

SEWING THREADS: WHITE (01), GREEN (02), CAMELO (03), BROWN (04), BLACK (05), SAND (06) OR GRAY (07).

NOTE: PRODUCT UNAVAILABLE IN SPECIAL MEASURES.

DESCRIPTION OF PRODUCT

ASIENTO: FIJO - CINTURÓN ELÁSTICO + HR + D20 SUAVE + D33 + FIBRA.

RESPALDO: FIJO - HR + D20 SUAVE + FIBRA.

PIES: PINTURA ELECTROSTÁTICA - PLOMO, MARRÓN O NEGRO.

DETALLE: PIEL, FIBRA DE PIEL O TELA.

DETALLE DE LA COSTURA: DETALLE - COSTURA G

LÍNEA DE LA COSTURA: BLANCO (01), VERDE (02), CAMELO (03), MARRÓN (04), NEGRO (05), ARENA (06) O GRIS (07).

OBSERVACIONES: PRODUCTO NO DISPONIBLE EN MEDIDAS ESPECIALES.

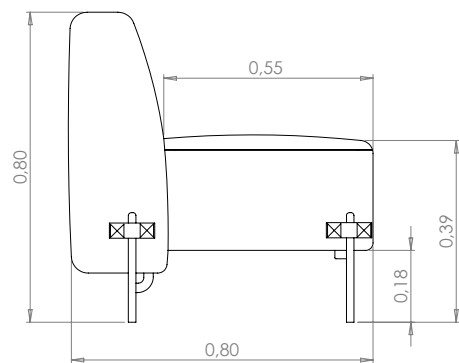
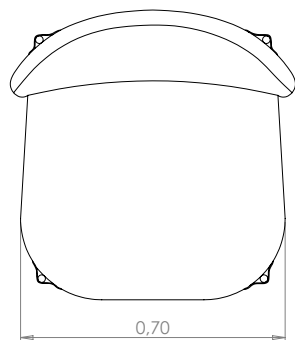

Configuração de Poltrona

Poltrona 70 - 1ass(70)

BREEZE

HOLLY

Design STUDIO FEELING



DESCRIÇÃO DO PRODUTO

ASSENTO: FIXO - MOLA + PERCINTA + HR + FIBRA.

ALMOFADA DE ENCOSTO: SOLTA - ALGODÃO + FIBRA.

ALMOFADA DECORTIVA: SOLTA - FIBRA SILICONADA.

ESTRUTURA ENCOSTO: PINTURA ELETROSTÁTICA - CHUMBO, MARROM OU BLACK.

BASE POLTRONA E CHAISE: GIRATÓRIA.

BASE PUFF: FIXA.

DETALHE COSTURA: COSTURA G

LINHA DETALHE COSTURA: BRANCO (01), VERDE (02), CARAMELO (03), MARROM (04), PRETO (05), AREIA (06) OU CINZA (07)

OBSERVAÇÕES: CONFIGURAÇÕES DE PUFF NÃO CONTÉM DETALHE DE COSTURA NO TAMPO DO ASSENTO.

PRODUTO INDISPONÍVEL EM MEDIDAS ESPECIAIS.

HOLLY



DESCRIPCIÓN DEL PRODUCTO

SEAT: FIXED - SPRING + ELASTIC BELT + HR + FIBER.

BACKREST CUSHION: LOOSE - COTTON + FIBER.

DECORATIVE CUSHION: LOOSE - SILICONIZED FIBER.

BACKREST STRUCTURE: ELECTROSTATIC PAINTING - LEAD, BROWN OR BLACK.
BASE ARMCHAIR AND CHAISE: ROTATING.

BASE PUFF: FIXED.

SEWING DETAIL: G-SEWING

SEWING THREADS: WHITE (01), GREEN (02), CARAMEL (03), BROWN (04), BLACK (05), SAND (06) OR GRAY (07).

NOTE: PUFF CONFIGURATIONS DO NOT CONTAIN STITCHING DETAIL ON THE SEAT TOP.

PRODUCT UNAVAILABLE IN SPECIAL MEASURES.

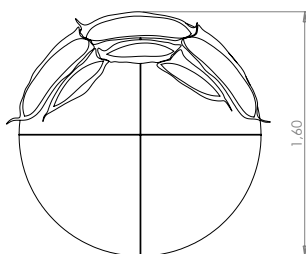

Configurações de Chaise

Chaise 145 - 1ass(145) + 3alm/enc(83x55) + 3alm/dec(50x50)

Chaise 160 - 1ass(160) + 3alm/enc(90x55) + 3alm/dec(50x50)

DESCRIPTION OF PRODUCT

ASIENTO: FIJO - RESORTE + CINTURÓN ELÁSTICO + HR + FIBRA.

ALMOHADA DE RESPALDO: SUELTO - ALGODÓN + FIBRA.

ALMOHADA DECORATIVA: SUELTO - FIBRA SILICONADA.

ESTRUTURA DEL RESPALDO: PINTURA ELETROSTÁTICA - PLOMO, MARRÓN O NEGRO.

BASE SILLÓN Y CHAISE: GIRATORIA.

BASE PUFF: FIJA.

DETALLE DE COSTURA: COSTURA G.

DETALLE DE LA COSTURA: BLANCO (01), VERDE (02), CARAMELO (03), MARRÓN (04), NEGRO (05), ARENA (06) O GRIS (07).

OBSERVACIONES: LAS CONFIGURACIONES DE PUFF NO CONTIENEN DETALLES DE COSTURA EN LA PARTE SUPERIOR DEL ASIENTO.

PRODUCTO NO DISPONIBLE EN MEDIDAS ESPECIALES.

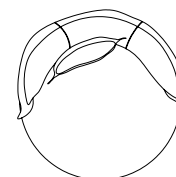

Configuração de Poltrona

Poltrona 89 - 1ass(89) + 1alm/enc(180x60) + 1alm/dec(50x50)

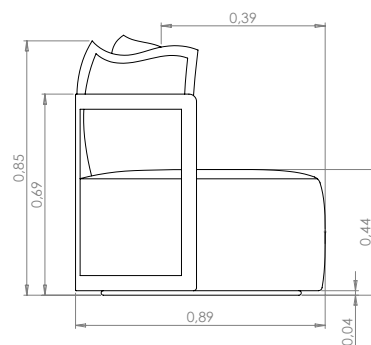

Configurações de Puff

Puff 89 - 1puff(89x89)

Puff 110 - 1puff(110x110)

Puff 130 - 1puff(130x130)



LEXUS

Design PEDRO MENDES



FEELING ESTOFADOS | *Coleção Cotidiano*

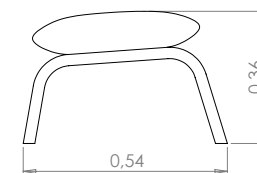
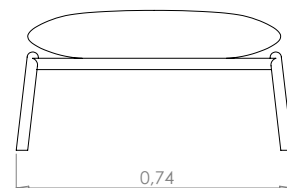

Configuração de Puff

Puff 74 - 1puff(74x54)

DESCRIÇÃO DO PRODUTO

ASSENTO: FIXO - MOLA + HR + FIBRA.

ALMOFADA DE ENCOSTO: SOLTA - PENA DE GANSO.

BASE: PINTURA ELETROSTÁTICA - CHUMBO, MARROM OU BLACK.

DETALHES: FIVELA - GRAFITE.

OPCIONAIS: ALMOFADA DE ENCOSTO - FIBRA.

OBSERVAÇÕES: DETALHE INDISPONÍVEL EM RECOURO.

DESCRIPTION OF PRODUCT

SEAT: FIXED - SPRING + HR + FIBER.

BACKREST CUSHION: LOOSE - GOOSE FEATHER.

BASE: ELECTROSTATIC PAINT - LEAD, BROWN OR BLACK.

DETAILS: BUCKLE - GRAPHITE.

OPTIONAL: BACKREST CUSHION - FIBER.

NOTE: DETAIL UNAVAILABLE IN LEATHER

DESCRIPCIÓN DEL PRODUCTO

ASIENTO: FIJO - RESORTE + HR + FIBRA.

ALMOHADA DE RESPALDO: SUELTO - PLUMA DE OCA.

BASE: PINTURA ELECTROSTÁTICA - PLOMO, MARRÓN O NEGRO.

DETALLES: CIERRE - GRAFITO.

OPCIONAL: ALMOHADA DE RESPALDO - FIBRA.

OBSERVACIONES: DETALLE NO DISPONIBLE EN PIEL

LEXUS

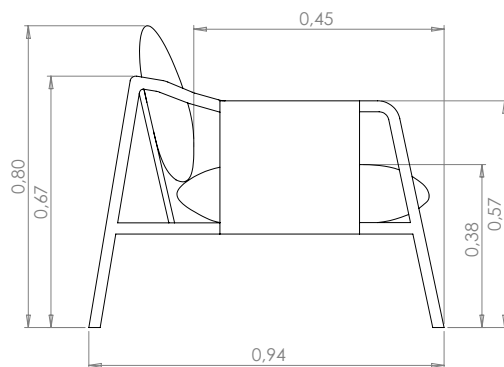
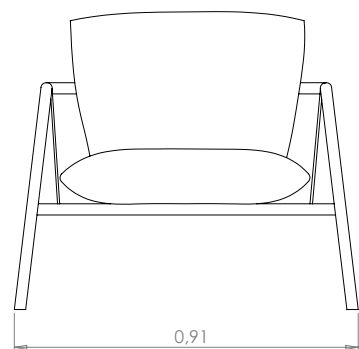

Configuração de Poltrona

Poltrona 91 - 1ass(69) + 2br(11) + 1alm/enc(60x50)



NINA

Design DANIELA FERRO



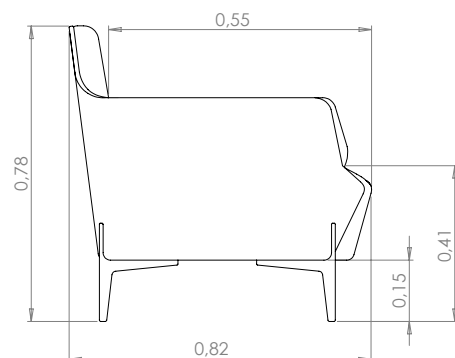
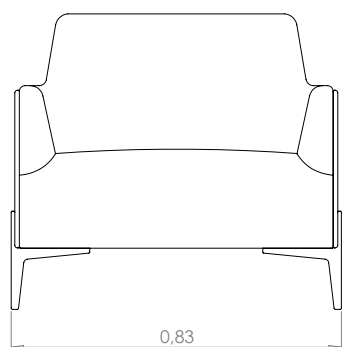

Configuração de Poltrona

Poltrona 83 - 1ass(63) + 2br(10)

NINA



DESCRIÇÃO DO PRODUTO

ASSENTO: FIXO - MOLA + D33 + D20 SOFT + FIBRA.

ENCOSTO: FIXO - PERCINTA + D33 + D20 SOFT + FIBRA.

PÉS: PINTURA ELETROSTÁTICA - CHUMBO, MARROM OU BLACK.

LÂMINA NATURAL - CARVALHO NATURAL, CARVALHO EBANIZADO, CARVALHO LINEN OU NOGUEIRA.

OBSERVAÇÕES: OS PÉS LAMINADOS TEM COMO PADRÃO AS BORDAS PINTADAS.

DESCRIPTION OF PRODUCT

SEAT: FIXED - SPRING + D33 + D20 SOFT + FIBER.

BACKREST: FIXED - ELASTIC BELT + D33 + D20 SOFT + FIBER.

FEET: ELECTROSTATIC PAINTING - LEAD, BROWN OR BLACK.

NATURAL VENEER - NATURAL OAK, EBANIZED OAK, OAK LINEN OR WALNUT.

NOTE: LAMINATED FEET HAVE PAINTED EDGES AS STANDARD

DESCRIPCIÓN DEL PRODUCTO

ASIENTO: FIJO - RESORTE + D33 + D20 SUAVE + FIBRA.

RESPALDO: FIJO - CINTURÓN ELÁSTICO + D33 + D20 SUAVE + FIBRA.

PIES: PINTURA ELECTROSTÁTICA - PLOMO, MARRÓN O NEGRO.

CHAPA NATURAL - ROBLE NATURAL, ROBLE EBANIZADO, ROBLE LINO O NOGAL.

OBSERVACIONES: LOS PIES LAMINADOS TIENEN BORDES PINTADOS POR DEFECTO.

ONO

Design DANIELA FERRO



FEELING ESTOFADOS | *Coleção Cotidiano*

DESCRIÇÃO DO PRODUTO

ASSENTO: FIXO - MOLA + D33 + D20 SOFT + FIBRA.

ENCOSTO: FIXO - PERCINTA + D33 + D20 SOFT + FIBRA.

PÉS: PINTURA ELETROSTÁTICA - CHUMBO, MARROM OU BLACK.

LÂMINA NATURAL - CARVALHO NATURAL, CARVALHO EBANIZADO, CARVALHO LINEN OU NOGUEIRA.

OBSERVAÇÕES: OS PÉS LAMINADOS TEM COMO PADRÃO AS BORDAS PINTADAS.

DESCRIPTION OF PRODUCT

SEAT: FIXED - SPRING + D33 + D20 SOFT + FIBER.

BACKREST: FIXED - ELASTIC BELT + D33 + D20 SOFT + FIBER.C12

FEET: ELECTROSTATIC PAINTING - LEAD, BROWN OR BLACK.

NATURAL VENEER - NATURAL OAK, EBANIZED OAK, OAK LINEN OR WALNUT.

NOTE: LAMINATED FEET HAVE PAINTED EDGES AS STANDARD.



ONO

DESCRIPCIÓN DEL PRODUCTO

ASIENTO: FIJO - RESORTE + D33 + D20 SUAVE + FIBRA.

RESPALDO: FIJO - CINTURÓN ELÁSTICO + D33 + D20 SUAVE + FIBRA.
C12

PIES: PINTURA ELECTROSTÁTICA - PLOMO, MARRÓN O NEGRO.
CHAPA NATURAL - ROBLE NATURAL, ROBLE EBANIZADO, ROBLE LINO O NOGAL.

OBSERVACIONES: LOS PIES LAMINADOS TIENEN BORDES PINTADOS POR DEFECTO.

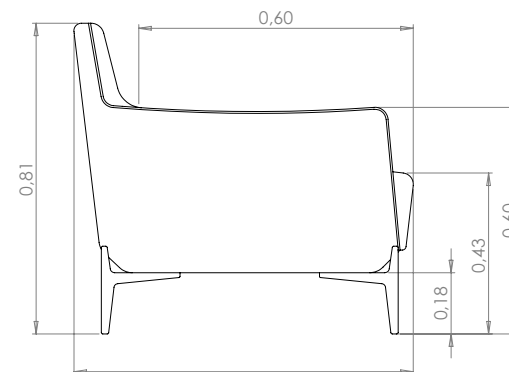
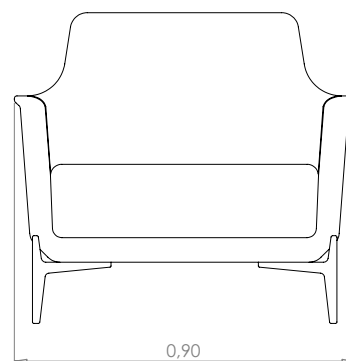

Configuração de Poltrona

Poltrona 90 - 1ass(66) - 2br(12)



PALLA

Design STUDIO FEELING



DESCRIÇÃO DO PRODUTO

ASSENTO: FIXO - PERCINTA + HR + D26 ULTRACEL + D20 SOFT + FIBRA.

ALMOFADA DE ENCOSTO: SOLTA - PENA DE GANSO.

ALMOFADA DECORATIVA: SOLTA - PENA DE GANSO.

ESTRUTURA: PINTURA ELETROSTÁTICA - CHUMBO, MARROM OU BLACK.

PÉS FIXO: IMBUÍA.

BASE: GIRATÓRIA.

OBSERVAÇÕES: TIRAS INDISPONÍVEIS EM TECIDO.

PRODUTO INDISPONÍVEL EM MEDIDAS ESPECIAIS.

DESCRIPTION OF PRODUCT

SEAT: FIXED - ELASTIC BELT + HR + D26 ULTRACEL + D20 SOFT + FIBER.

BACKREST CUSHION: LOOSE - GOOSE FEATHER.

DECORATIVE CUSHION: LOOSE - GOOSE FEATHER.

FRAME: ELECTROSTATIC PAINTING - LEAD, BROWN OR BLACK.

FIXED LEGS: IMBUÍA.

BASE: ROTATING.

OBSERVATIONS: STRIPS UNAVAILABLE IN FABRIC.

PRODUCT UNAVAILABLE IN SPECIAL MEASURES

DESCRIPCIÓN DEL PRODUCTO

ASIENTO: FIJO - CINTURÓN ELÁSTICO + HR + D26 ULTRACEL + D20 SOFT + FIBRA.

ALMOHADA DE RESPALDO: SUELTO - PLUMA DE OCA.

ALMOHADA DECORATIVA: SUELTO - PLUMA DE OCA.

MARCO: PINTURA ELECTROSTÁTICA - PLOMO, MARRÓN O NEGRO.

PATAS FIJAS: IMBUÍA.

BASE: GIRATORIA.

OBSERVACIONES: TIRAS NO DISPONIBLES EN TELA

PRODUCTO NO DISPONIBLE EN MEDIDAS ESPECIALES.

PALLA

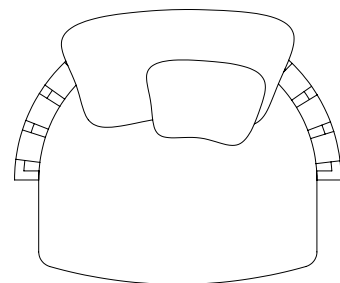

Configuração de Poltrona fixa

Poltrona fixa 95 - 1 ass(73) + 2 br(11) + 1 alm/enc(60x50) + 1 alm/dec(40x40)

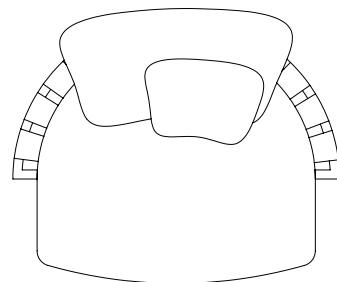

Configuração de Poltrona giratória

Poltrona gir 95 - 1 ass(73) + 2 br(11) + 1 alm/enc(60x50) + 1 alm/dec(40x40)

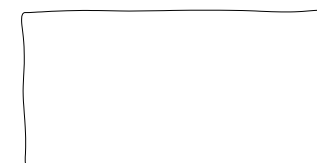
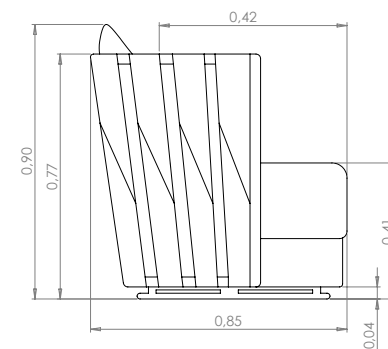

Configuração de Almofada

Alm/enc(60x50)



SUEN

Design STUDIO FEELING



DESCRIÇÃO DO PRODUTO

ASSENTO: FIXO - HR + D20 SOFT + FIBRA.

ENCOSTO: FIXO - D20 SOFT + FIBRA.

PÉ: PINTURA ELETROSTÁTICA - CHUMBO, MARROM OU BLACK.

LÂMINA NATURAL - CARVALHO NATURAL, CARVALHO EBONIZADO, CARVALHO LINEN OU NOGUEIRA.

DETALHES: ZIPPER - BEGE, CINZA, CHUMBO OU PRETO.

OBSERVAÇÕES: OS PÉS LAMINADOS TEM COMO PADRÃO AS BORDAS PINTADAS. PRODUTO INDISPONÍVEL EM MEDIDAS ESPECIAIS.

DESCRIPTION OF PRODUCT

SEAT: FIXED - HR + D20 SOFT + FIBER.

BACKREST: FIXED - D20 SOFT + FIBER.

FOOT: ELECTROSTATIC PAINT - LEAD, BROWN OR BLACK.

NATURAL VENEER - NATURAL OAK, EBONIZED OAK, OAK LINEN OR WALNUT.

DETAILS: ZIPPER - BEIGE, GRAY, LEAD OR BLACK.

NOTE: LAMINATED FEET HAVE PAINTED EDGES AS STANDARD. PRODUCT UNAVAILABLE IN SPECIAL MEASURES.

DESCRIPCIÓN DEL PRODUCTO

ASIENTO: FIJO - HR + D20 SUAVE + FIBRA.

RESPALDO: FIJO - D20 SUAVE + FIBRA.

PIE: PINTURA ELECTROSTÁTICA - PLOMO, MARRÓN O NEGRO.

CHAPA NATURAL - ROBLE NATURAL, ROBLE EBONIZADO, ROBLE LINO O NOGAL.

DETALLES: CREMALLERA - BEIGE, GRIS, PLOMO O NEGRO.

OBSERVACIONES: LOS PIES LAMINADOS TIENEN BORDES PINTADOS POR DEFECTO. PRODUCTO NO DISPONIBLE EN MEDIDAS ESPECIALES.

SUEN

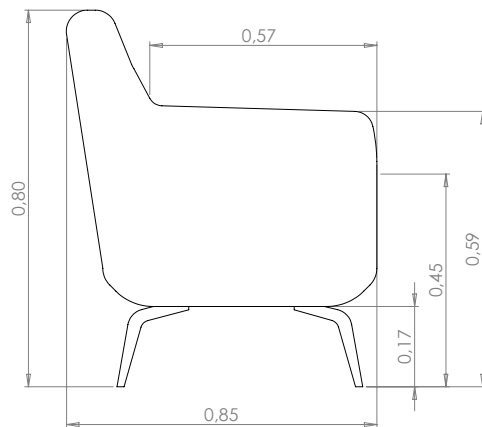
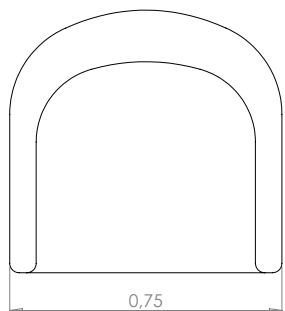

Configuração de Poltrona

Poltrona 75 - 1ass(59) + 2br(8)



TURQUESA

Design STUDIO FEELING



DESCRIÇÃO DO PRODUTO

ASSENTO: FIXO - PERCINTA ELÁSTICA + D33 + D26 ULTRACEL + HR + FIBRA.

ENCOSTO: FIXO - D20 SOFT + FIBRA.

BASE FIXA: PINTURA LACA - FENDI, NUDE, BRANCO OU PRETO.

TINGIMENTO - CARVALHO NATURAL, CARVALHO EBANIZADO, CARVALHO LINEN OU NOGUEIRA.

BASE GIRATÓRIA: POLIDO ALUMÍNIO.

OPCIONAIS: BASE FIXA OU GIRATÓRIA.

DESCRIPTION OF PRODUCT

SEAT: FIXED - ELASTIC BELT + D33 + D26 ULTRACEL + HR + FIBER.

BACKREST: FIXED - D20 SOFT + FIBER.

FIXED BASE: LACQUER PAINT - FENDI, NUDE, WHITE OR BLACK.

DYEING - NATURAL OAK, EBONIZED OAK, OAK LINEN OR WALNUT.

ROTATING BASE: POLISHED ALUMINUM.

OPTIONAL: FIXED OR ROTATING BASE.

DESCRIPCIÓN DEL PRODUCTO

ASIENTO: FIJO - CORREA ELÁSTICA + D33 + D26 ULTRACEL + HR + FIBRA.

RESPALDO: FIJO - D20 SUAVE + FIBRA.

BASE FIJA: PINTURA DE LACA - FENDI, NUDE, BLANCO O NEGRO.

TINTE - ROBLE NATURAL, ROBLE EBONIZADO, ROBLE LINO O NOGAL.

BASE GIRATORIA: ALUMINIO PULIDO.

OPCIONAL: BASE FIJA O GIRATORIA

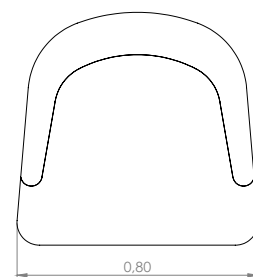

Cofiguração de Poltrona

Poltrona 80 - 1 ass(70) + 2br(5)

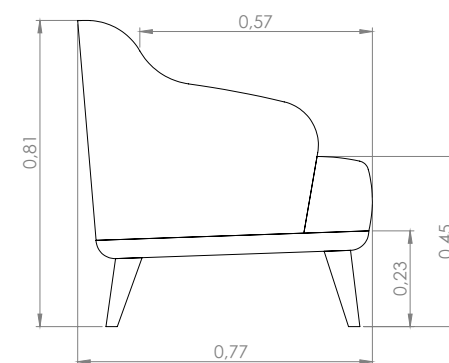

Cofiguração de PUFF

Puff 63 - 1puff(63x53)

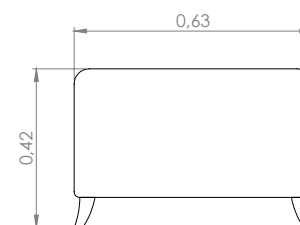

EXCELENTE
COMBINAÇÃO
DE COURO
& LINHO

TURQUESA

SPLENDORE

Design STUDIO FEELING



DESCRIÇÃO DO PRODUTO

ASSENTO: FIXO - PERCINTA + D33 + D26 ULTRACEL + FIBRA.

ENCOSTO: FIXO - D33 + D20 SOFT + D23 HIPER + FBRA.

ALMOFADA DE ENCOSTO: SOLTA - D23 HIPER + D26 ULTRACEL + FIBRA.

BASE: LÂMINA NATURAL - CARVALHO NATURAL, CARVALHO EBANIZADO, CARVALHO LINEN OU NOGUEIRA.

PÉS: PINTURA ELETROSTÁTICA - CHUMBO, MARROM OU BLACK. POLIDO - ALUMÍNIO.

DETALHES: BRAÇO - ALUMÍNIO, CHUMBO, MARROM OU BLACK.

COSTURA DIFERENCIADA: BRAÇO - COSTURA G

LINHA DETALHE COSTURA: BRANCO (01), VERDE (02), CAMELO (03), MARROM (04), PRETO (05), AREIA (06) OU CINZA (07).

DESCRIPTION OF PRODUCT

SEAT: FIXED - ELASTIC BELT + D33 + D26 ULTRACEL + FIBER.

BACKREST: FIXED - D33 + D20 SOFT + D23 HYPER + FIBER.

BACKREST CUSHION: LOOSE - D23 HYPER + D26 ULTRACEL + FIBER.

BASE: NATURAL VENEER - NATURAL OAK, EBANIZED OAK, OAK LINEN OR WALNUT.

FOOT: ELECTROSTATIC PAINTING - LEAD, BROWN OR BLACK. POLISHED - ALUMINUM.

DETAILS: ARM - ALUMINUM, LEAD, BROWN OR BLACK.

DISTINGUISHED SEWING: ARM - SEWING G

SEWING THREAD: WHITE (01), GREEN(02), CAMELO(03), BROWN(04), BLACK(05), SAND(06) OR GRAY(07).

DESCRIPCIÓN DEL PRODUCTO

ASIENTO: FIJO - CINTURÓN ELÁSTICO + D33 + D26 ULTRACEL + FIBRA.

RESPALDO: FIJO - D33 + D20 SUAVE + D23 HIPER + FIBRA.

ALMOHADA DE RESPALDO: SUELTO - D23 HIPER + D26 ULTRACEL + FIBRA.

BASE: CHAPA NATURAL - ROBLE NATURAL, ROBLE EBANIZADO, ROBLE LINO O NOGAL.

PIES: PINTURA ELECTROSTÁTICA - PLOMO, MARRÓN O NEGRO. PULIDO - ALUMINIO.

DETALLES: BRAZO - ALUMINIO, PLOMO, MARRÓN O NEGRO.

COSTURA DIFERENCIAL: BRAZO - COSTURA G

DETALLES DEL HILO: BLANCO(01), VERDE(02), CAMELO(03), MARRÓN(04), NEGRO(05), ARENA(06) O GRIS(07).

SPLENDORE

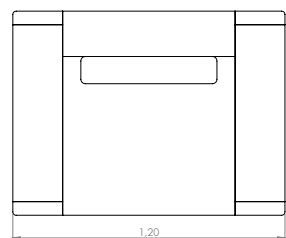

Configuração de Poltrona com assento ultracel

Poltrona 120 - 1ass/ult(76) + 2br(22) + 1alm/enc(76x47)

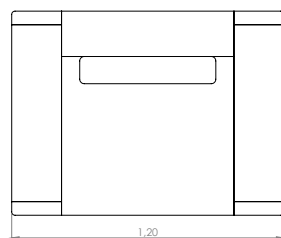

Configuração de Poltrona com assento latex

Poltrona 120 - 1ass/lat(76) + 2br(22) + 1alm/enc(76x47)

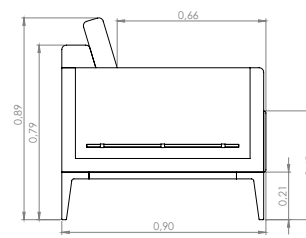

FORM

Design STUDIO FEELING



FEELING ESTOFADOS | *Coleção Cotidiano*

DESCRIÇÃO DO PRODUTO

ASSENTO: FIXO - PERCINTA + D33 + D20 SOFT + FIBRA.

ENCOSTO: FIXO - D20 SOFT + FIBRA.

BASE FIXA: TINGIMENTO - NATURAL, EBANIZADO, NOGUEIRA, LINEN, NOZES OU IMBUÍA.

PINTURA LACA - BRANCO, PRETO, FENDI OU NUDE.

BASE GIRATÓRIA: PRETA.

OBSERVAÇÕES: BASE GIRATÓRIA INDISPONÍVEL PARA A CONFIGURAÇÃO DE PUFF.

DESCRIPTION OF PRODUCT

SEAT: FIXED - ELASTIC BELT + D33 + D20 SOFT + FIBER.

BACKREST: FIXED - D20 SOFT + FIBER.

FIXED BASE: DYEING - NATURAL, EBANIZED, WALNUT, LINEN, WALNUT OR IMBUÍA.

LACQUER PAINTING - WHITE, BLACK, FENDI OR NUDE.

ROTATING BASE: BLACK.

NOTE: ROTATING BASE UNAVAILABLE FOR PUFF CONFIGURATION.

DESCRIPCIÓN DEL PRODUCTO

ASIENTO: FIJO - CINTURÓN ELÁSTICO + D33 + D20 SUAVE + FIBRA.

RESPALDO: FIJO - D20 SUAVE + FIBRA.

BASE FIJA: TINTE - NATURAL, EBANIZADO, NOGAL, LINO, NOGAL O IMBUÍA. ACABADO LACADO - BLANCO, NEGRO, FENDI O NUDE.

BASE GIRATORIA: NEGRA.

OBSERVACIONES: BASE GIRATORIA NO DISPONIBLE PARA LA CONFIGURACIÓN PUFF.

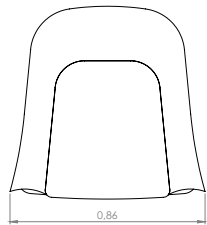

Configuração de Poltrona fixa

Poltrona fixa 86 - 1 ass(58) + 2br(14)

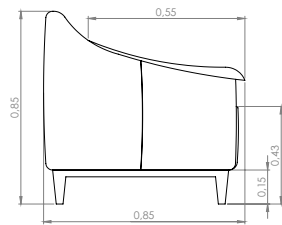

FORM

FORM SLIM

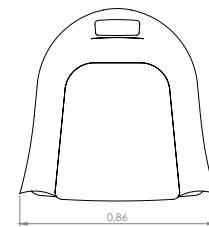

Configuração de Poltrona fixa

Poltrona fixa 86 - 1 ass(58) + 2br(14)

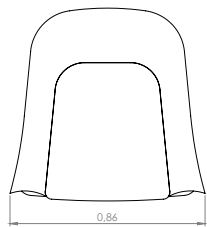
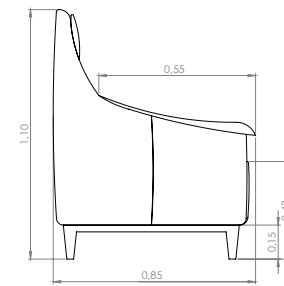

Configuração de Poltrona giratória

Poltrona gir 86 - 1 ass(58) + 2br(14)

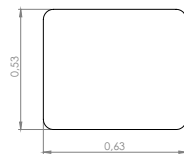

Configuração de Puff

Puff 63 - 1puff(63x53)

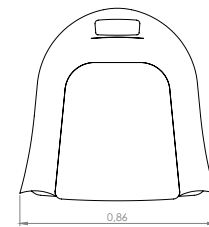
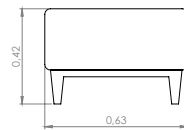

Configuração de Poltrona giratória

Poltrona gir 86 - 1 ass(58) + 2br(14)



C O M P L E M E N T O S
C A M A S E





AFRODITE

Design STUDIO FEELING



DESCRIÇÃO DO PRODUTO

CABECEIRA: FIXO - D33.

GAVETÃO: FIXO - D33.

PÉ/BASE: PINTURA ELETROSTÁTICA - CHUMBO, MARROM OU BLACK.

OBSERVAÇÕES: QUANDO A CABECEIRA FOR REVESTIDA NO COURO TRANÇADO, É POSSÍVEL ENCONTRAR ALGUMAS UNIFORMIDADES POR SER TRATAR DE UM PRODUTO ARTESANAL. O COURO TRANÇADO ESTÁ DISPONÍVEL SOMENTE NO COR CINZA E NA COMBINAÇÃO OFF WHITE/CAMURÇA PRETO.

DESCRIPTION OF PRODUCT

HEADBOARD: FIXED - D33.

INVOLVING STRUCTURE: FIXED - D33.

FOOT/BASE: ELECTROSTATIC PAINTING - LEAD, BROWN OR BLACK.

NOTE: WHEN THE HEADBOARD IS COVERED IN BRAIDED LEATHER, IT IS POSSIBLE TO FIND SOME UNIFORMITIES BECAUSE IT IS A HANDMADE PRODUCT. THE BRAIDED LEATHER IS ONLY AVAILABLE IN GRAY AND IN THE OFF WHITE/BLACK SUEDE COMBINATION.



DESCRIPCIÓN DEL PRODUCTO

CABECERO: FIJO - D33.

CAJÓN: FIJO - D33.

PIE/BASE: PINTURA ELECTROSTÁTICA - PLOMO, MARRÓN O NEGRO.

OBSERVACIONES: CUANDO EL CABECERO ESTÁ CUBIERTO DE PIEL TRENZADO, ES POSIBLE ENCONTRAR ALGUNAS UNIFORMIDADES PORQUE ES UN PRODUCTO HECHO A MANO.

LA PIEL TRENZADA SÓLO ESTÁ DISPONIBLE EN GRIS Y EN LA COMBINACIÓN DE OFF WHITE/ANTE NEGRO.



Configurações de Base

Base 110x200 (colchão 88x188)
Base 160x200 (colchão 138x188)
Base 180x210 (colchão 158x198)
Base 215x215 (colchão 193x203)
Base Bip 160x200 (colchão 138x188)
Base Bip 180x210 (colchão 158x198)
Base Bip 215x215 (colchão 193x203)

Configurações de Cama

Cama 110x215 (colchão 88x188)
Cama 160x215 (colchão 138x188)
Cama 180x225 (colchão 158x198)
Cama 215x230 (colchão 193x203)
Cama Bip 160x215 (colchão 138x188)
Cama Bip 180x225 (colchão 158x198)
Cama Bip 215x230 (colchão 193x203)

Configurações de Cama com encosto em couro trançado

Cama/CT 110x215 (colchão 88x188)
Cama/CT 160x215 (colchão 138x188)
Cama/CT 180x225 (colchão 158x198)
Cama/CT 215x230 (colchão 193x203)
Cama/CT Bip 160x215 (colchão 138x188)
Cama/CT Bip 180x225 (colchão 158x198)
Cama/CT Bip 215x230 (colchão 193x203)

HUG

Design MAURICIO BOMFIM



FEELING ESTOFADOS | *Coleção Cotidiano*

DESCRIÇÃO DO PRODUTO

CABECEIRA: FIXO - D20 SOFT.

GAVETÃO: FIXO - D33.

PÉS: PINTURA ELETROSTÁTICA - MARROM, CHUMBO OU BLACK.

OBSERVAÇÕES: AS OPÇÕES BIPARTIDAS TEM A BASE DIVIDIDA AO MEIO NA PROFUNDIDADE.

DESCRIPTION OF PRODUCT

HEADBOARD: FIXED - D20 SOFT.

INVOLVING STRUCTURE: FIXED - D33.

FEET: ELECTROSTATIC PAINTING - BROWN, LEAD OR BLACK.

NOTE: THE SPLIT OPTIONS HAVE THE BASE DIVIDED IN HALF IN THE DEPTH.

DESCRIPCIÓN DEL PRODUCTO

CABECERA: FIJA - D20 SUAVE.

CAJÓN: FIJO - D33.

PIES: PINTURA ELECTROSTÁTICA - MARRÓN, PLOMO O NEGRO.

OBSERVACIONES: LAS OPCIONES BIPARTITAS TIENEN LA BASE DIVIDIDA POR LA MITAD EN PROFUNDIDAD.

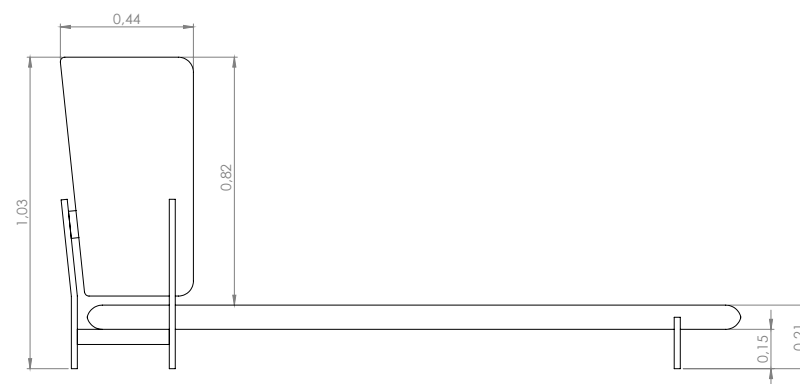

Configurações de Cama

Cama 120x210 (Colchão 88x188)

Cama 170x210 (Colchão 138x188)

Cama 190x220 (Colchão 158x198)

Cama 225x225 (Colchão 193x203)

Cama Bip 170x210 (Colchão 138x188)

Cama Bip 190x220 (Colchão 158x198)

Cama Bip 225x225 (Colchão 193x203)

Configurações de Base

Base 112x198 (Colchão 88x188)

Base 162x198 (Colchão 138x188)

Base 182x208 (Colchão 158x198)

Base 217x213 (Colchão 193x203)

Base Bip 162x198 (Colchão 138x188)

Base Bip 182x208 (Colchão 158x198)

Base Bip 217x213 (Colchão 193x203)

HUG



JADE

Design STUDIO FEELING



DESCRIÇÃO DO PRODUTO

CABECEIRA: FIXO - D33 + FIBRA.

BASE: FIXA - D33.

PÉS: PINTURA ELETROSTÁTICA - CHUMBO, MARROM OU BLACK.
POLIMENTO - ALUMÍNIO.

LINHA DETALHE COSTURA: BRANCO (01), VERDE (02), CAMELO (03),
MARROM (04), PRETO (05), AREIA (06) OU CINZA (07)

OBSERVAÇÕES: QUANDO REVESTIDA EM COURO, DEVIDO AO LIMITE DE
TAMANHO DA PELE, A CAMA TERÁ COSTURAS DIFERENCIADAS NO ENCOSTO
E GAVETÃO. A COR DA LINHA SERÁ OPCIONAL APENAS QUANDO A CAMA
FOR REVESTIDA EM COURO. AS OPÇÕES DE CABECEIRA POSSUEM PÉS
PLÁSTICOS DE 1CM. AS OPÇÕES BIPARTIDAS TEM A BASE DIVIDIDA AO MEIO
NA PROFUNDIDADE.

DESCRIPTION OF PRODUCT

HEADBOARD: FIXED - D33 + FIBER.

BASE: FIXED - D33.

FEET: ELECTROSTATIC PAINTING - LEAD, BROWN OR BLACK.
POLISHING - ALUMINUM.

SEWING THREADS: WHITE (01), GREEN (02), CAMELO (03), BROWN (04),
BLACK (05), SAND (06) OR GRAY (07).

NOTE: WHEN COVERED IN LEATHER, DUE TO THE SIZE LIMIT OF THE LEATHER, THE
BED WILL HAVE DIFFERENTIATED SEWING IN THE BACKREST AND INVOLVING
STRUCTURE. THE THREAD COLOR WILL BE OPTIONAL ONLY WHEN THE BED IS
COVERED IN LEATHER. THE HEADBOARD OPTIONS HAVE 1CM PLASTIC FEET.
THE SPLIT OPTIONS HAVE THE BASE DIVIDED IN HALF IN THE DEPTH

DESCRIPCIÓN DEL PRODUCTO

CABECERO: FIJO - D33 + FIBRA.

BASE: FIJA - D33.

PIES: PINTURA ELECTROSTÁTICA - PLOMO, MARRÓN O NEGRO.
PULIDO - ALUMINIO.

DETALLE DE LA LÍNEA DE COSTURA: BLANCO (01), VERDE (02), CAMELO
(03), MARRÓN (04), NEGRO (05), ARENA (06) O GRIS (07).

OBSERVACIONES: CUANDO SE CUBRE CON PIEL, DEBIDO AL LÍMITE DE
TAMAÑO DE LA PIEL, LA CAMA TENDRÁ COSTURAS DIFERENCIADAS EN EL
RESPALDO Y EL CAJÓN. EL COLOR DEL HILO SERÁ OPCIONAL SÓLO CUANDO
LA CAMA ESTÉ CUBIERTA DE PIEL. LAS OPCIONES DE CABECERA TIENEN PIES
DE PLÁSTICO DE 1CM. LAS OPCIONES DIVIDIDAS TIENEN LA BASE DIVIDIDA
POR LA MITAD EN PROFUNDIDAD

JADE



Configuração de Cama:

Cama 88x205 (Colchão 88x188)
Cama 138x205 (Colchão 138x188)
Cama 158x215 (Colchão 158x198)
Cama 193x220 (Colchão 193x203)
Cama bip 138x205 (Colchão 138x188)
Cama bip 158x215 (Colchão 158x198)
Cama bip 193x220 (Colchão 193x203)

Configuração de Cabeceira:

Cabeceira 88 - 88x120
Cabeceira 138 - 138x120
Cabeceira 158 - 158x120
Cabeceira 193 - 193x120

Configuração de Base:

Base 88x188 (Colchão 88x188)
Base 138x188 (Colchão 138x188)
Base 158x198 (Colchão 158x198)
Base 193x203 (Colchão 193x203)
Base bip 138x188 (Colchão 138x188)
Base bip 158x198 (Colchão 158x198)
Base bip 193x203 (Colchão 193x203)

BALI

Design STUDIO FEELING



FEELING ESTOFADOS | *Coleção Cotidiano*

DESCRIÇÃO DO PRODUTO

ENCOSTO: FIXO - D33 + D20 SOFT + FIBRA.

GAVETÃO: FIXO - D33.

PÉS: PINTURA ELETROSTÁTICA - MARROM, CHUMBO OU BLACK.

OBSERVAÇÕES: AS OPÇÕES DE CABECEIRA POSSUEM PÉS PLÁSTICOS DE 1CM.
AS OPÇÕES BIPARTIDAS TÊM A BASE DIVIDIDA AO MEIO NA PROFUNDIDADE.

DESCRIPTION OF PRODUCT

BACKREST: FIXED - D33 + D20 SOFT + FIBER.

INVOLVING STRUCTURE: FIXED - D33.

FEET: ELECTROSTATIC PAINTING - BROWN, LEAD, OR BLACK.

OBSERVATIONS: THE HEADBOARD OPTIONS HAVE 1CM PLASTIC FEET.
THE SPLIT OPTIONS HAVE THE BASE DIVIDED IN HALF IN THE DEPTH.

DESCRIPCIÓN DEL PRODUCTO

RESPALDO: FIJO - D33 + D20 BLANDO + FIBRA.

CAJÓN: FIJO - D33.

PIES: PINTURA ELECTROSTÁTICA - MARRÓN, PLOMO O NEGRO.

OBSERVACIONES: LAS OPCIONES DE CABECERA TIENEN PIES DE PLÁSTICO DE 1 CM. LAS OPCIONES BIPARTIDAS TIENEN LA BASE DIVIDIDA A LA MITAD DE LA PROFUNDIDAD.

BALI



Configurações de Cama

Cama 110x215 (Colchão 88x188)

Cama 160x215 (Colchão 138x188)

Cama 180x225 (Colchão 158x198)

Cama 215x230 (Colchão 193x203)

Cama Bip 160x215 (Colchão 138x188)

Cama Bip 180x225 (Colchão 158x198)

Cama Bip 215x230 (Colchão 193x203)

Configurações de Base

Base 110x200 (Colchão 88x188)

Base 160x200 (Colchão 138x188)

Base 180x210 (Colchão 158x198)

Base 215x215 (Colchão 193x203)

Base Bip 160x200 (Colchão 138x188)

Base Bip 180x210 (Colchão 158x198)

Base Bip 215x215 (Colchão 193x203)

Configurações de Cabeceira

Cabeceira 110 - 110x15x110

Cabeceira 160 - 160x15x110

Cabeceira 180 - 180x15x110

Cabeceira 215 - 215x15x110



HARBOR

Design STUDIO FEELING



DESCRIÇÃO DO PRODUTO

CABECEIRA: FIXO - D33 + D20 SOFT + FIBRA.

GAVETÃO: FIXO - D33.

BASE: PINTURA ELETROSTÁTICA - CHUMBO, MARROM OU BLACK.

POLIMENTO - ALUMÍNIO.

OBSERVAÇÕES: AS OPÇÕES DE CABECEIRA POSSUEM PÉS PLÁSTICOS DE 1CM.

AS OPÇÕES BIPARTIDAS TEM A BASE DIVIDIDA AO MEIO NA PROFUNDIDADE. INDISPONÍVEL EM COURO.

DESCRIPTION OF PRODUCT

HEADBOARD: FIXED - D33 + D20 SOFT + FIBER.

INVOLVING STRUCTURE: FIXED - D33.

BASE: ELECTROSTATIC PAINTING - LEAD, BROWN OR BLACK.

POLISHING - ALUMINUM.

NOTE: THE HEADBOARD OPTIONS HAVE 1CM PLASTIC FEET.

THE BIPARTITE OPTIONS HAVE THE BASE DIVIDED IN HALF IN THE DEPTH.

NOT AVAILABLE IN LEATHER.

DESCRIPCIÓN DEL PRODUCTO

CABECERO: FIJO - D33 + D20 SUAVE + FIBRA.

CAJÓN: FIJO - D33.

BASE: PINTURA ELECTROSTÁTICA - PLOMO, MARRÓN O NEGRO.

PULIDO - ALUMINIO.

OBSERVACIONES: LAS OPCIONES DE CABECERA TIENEN PIES DE PLÁSTICO DE 1 CM. LAS OPCIONES BIPARTITAS TIENEN LA BASE DIVIDIDA POR LA MITAD EN LA PROFUNDIDAD. NO ESTÁ DISPONIBLE EN PIEL.

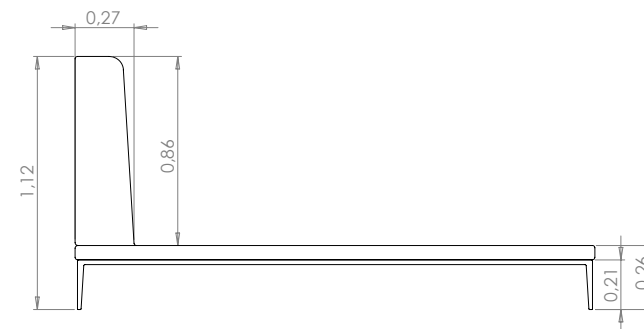

Configuração de Cama:

Cama 110x215 (Colchão 88x188)
Cama 160x215 (Colchão 138x188)
Cama 180x225 (Colchão 158x198)
Cama 215x230 (Colchão 193x203)
Cama Bip 160x215 (Colchão 138x188)
Cama Bip 180x225 (Colchão 158x198)
Cama Bip 215x230 (Colchão 193x203)

Configurações de Cabeceira

Cabeceira 110 - 110x27x112
Cabeceira 160 - 160x27x112
Cabeceira 180 - 180x27x112
Cabeceira 215 - 215x27x112

Configurações de Base

Base 110x200 (Colchão 88x188)
Base 160x200 (Colchão 138x188)
Base 180x210 (Colchão 158x198)
Base 215x215 (Colchão 193x203)
Base Bip 160x200 (Colchão 138x188)
Base Bip 180x210 (Colchão 158x198)
Base Bip 215x215 (Colchão 193x203)

COLCHÕES





A policromia da arquitetura Grega simbolizava a pureza dos materiais, garantia a qualidade das construções e inspirou o design dos colchões Feeling. O berço da civilização ocidental, na época da arquitetura clássica tem uma estética branca assim como nossos produtos, que além de contarem com um visual minimalista, possuem um conforto sem igual. Tudo para que você obtenha a mais alta qualidade de dormir, noite após noite.

SYROS

Design CAROLINA CARLESSO



ASSISTA O
CONCEITO
DESTE
PRODUTO

DESCRIÇÃO DO PRODUTO

BIOTIPO: ATE 165 KG

NIVEL DE CONFORTO: SUPERMACIO

TIPO DE MOLEJO: IENSACADA INDIVIDUALMENTE

TECIDO DO TAMPO: MALHA 410G/M² 100% POLIESTER

MATELASSE : FIBRA 100% POLIESTER 60 G/M² COM ESPUMA HIPERMACIA D24KG/M³ C/GEL 2,5CM - ULTRACEL E ESPUMA HIPERMACIA D24 KG/M³ 5,0CM - ULTRACEL

CAMADA DE CONFORTO: >LATEX REST D55 KG/M³ 5,0CM

DESCRIPTION OF PRODUCT

BIOTYPE: UP TO 165KG

COMFORT LEVEL: SUPER SOFT

CUSHION TYPE: INDIVIDUALLY POCKETED

TOP FABRIC: 410G/M² FABRIC 100% POLYESTER

MATTRESS: 100% POLYESTER FIBER 60G/M² WITH HYPERSOFT FOAM D24 KG/M³ (ULTRACEL) 2.5CM AND HYPERSOFT FOAM D24 KG/M³ (ULTRACEL) 5.0CM

COMFORT LAYER: LATEX REST D55 KG/M³ 5,0CM

DESCRIPCIÓN DEL PRODUCTO

BIOTIPO: HASTA 165 KG

NIVEL DE CONFORTO: SUPER BLANDO

TIPO DE ALMOHADA: EMBOLSADA INDIVIDUALMENTE

TEJIDO SUPERIOR: TEJIDO >410G/M² 100% POLIÉSTER

MATELASSE: FIBRA 100% POLIÉSTER 60 G/M² CON ESPUMA HIPERBLANDA D24 KG/M³ 1,0CM Y ESPUMA HIPERBLANDA (ULTRACEL) D24 KG/M³ 5,0CM

CAPA DE CONFORT: LATEX REST D55 KG/M³ 5,0CM

PARA UMA NOITE DE SONO RESTAURADOR

- Colchão Super Macio
- Durabilidade superior
- Maior conforto e resistência.



NAXOS

Design CAROLINA CARLESSO



ASSISTA O
CONCEITO
DESTE
PRODUTO

FEELING ESTOFADOS | *Coleção Cotidiano*

DESCRIÇÃO DO PRODUTO

BIOTIPO: ATE 165 KG

NIVEL DE CONFORTO: MACIO

TIPO DE MOLEJO: ENSACADA INDIVIDUALMENTE

TECIDO DO TAMPO: MALHA 410G/M² 100% POLIESTER

MATELASSE : FIBRA 100% POLIESTER 60 G/M² COM ESPUMA VISCOELASTICA GEL D45 KG/M³ 1,0CM E ESPUMA HIPERMACIA D24 KG/M³ 2,5CM (ULTRACEL)

CAMADA DE CONFORTO: ESPUMA HIPERMACIA D24 KG/M³ 5,0CM (ULTRACEL)
ESPUMA MACIA D36 KG/M³ 2,5CM

DESCRIPTION OF PRODUCT

BIOTYPE: UP TO 165 KG

COMFORT LEVEL: SOFT

CUSHION TYPE: INDIVIDUALLY POCKETED

TOP FABRIC: 410G/M² FABRIC 100% POLYESTER

MATTRESS: 100% POLYESTER FIBER 60 G/M² WITH D45 VISCOELASTIC GEL FOAM KG/M³ 1.0CM AND HYPERSOFT D24 KG/M³ 2.5CM (ULTRACEL)

COMFORT LAYER: HYPERSOFT FOAM D24 KG/M³ 5.0CM (ULTRACEL)
SOFT FOAM D36 KG/M³ 2.5CM

DESCRIPCIÓN DEL PRODUCTO

BIOTIPO: HASTA 165 KG

NIVEL DE CONFORTO: BLANDO

TIPO DE ALMOHADA: EMBOLSADA INDIVIDUALMENTE

TEJIDO SUPERIOR: TEJIDO >410G/M² 100% POLIÉSTER

MATELASSE: FIBRA 100% POLIÉSTER 60 G/M² CON ESPUMA GEL VISCOELÁSTICO D45 KG/M³ 1.0CM Y ESPUMA HIPERBLANDA D24 KG/M³ 2.5CM (ULTRACEL)

CAPA DE CONFORTO: ESPUMA DE HIPERBLANDA D24 KG/M³ 5.0CM (ULTRACEL)
ESPUMA BLANDA D36 KG/M³ 2.5CM

SEU SONO PERFEITO

- Colchão com conforto macio
- Durabilidade superior
- Produzido com espuma viscoelástica com gel que possibilita mais frescor ao corpo do usuário
- Preserva o Sono REM



TINOS

Design CAROLINA CARLESSO



ASSISTA O
CONCEITO
DESTE
PRODUTO

DESCRIÇÃO DO PRODUTO

BIOTIPO: ATE 155 KG

NIVEL DE CONFORTO: MACIO

TIPO DE MOLEJO: ENSACADA INDIVIDUALMENTE

TECIDO DO TAMPO: FIBRA 100% POLIESTER 60 G/M² COM ESPUMA HIPERMACIA D24 KG/M³ C/GEL 2,5CM (ULTRACEL)

E ESPUMA HIPERMACIA D24 KG/M³ 5,0CM (ULTRACEL)

CAMADA DE CONFORTO: LATEX D55 KG/M³ 8,0CM EM FORMATO DE COPOS COM 75MM DE ESPESSURA

DESCRIPTION OF PRODUCT

BIOTYPE: UP TO 155KG

COMFORT LEVEL: SOFT

CUSHION TYPE: INDIVIDUALLY POCKETED

TOP FABRIC: 410G/M² FABRIC 100% POLYESTER

MATTRESS: 100% POLYESTER FIBER 60G/M² WITH GEL HYPERSOFT FOAM D24 KG/M³ (ULTRACEL) 2.5CM AND HYPERSOFT FOAM D24 KG/M³ (ULTRACEL) 5.0CM

COMFORT LAYER: LATEX REST D55 KG/M³ 8,0CM CUP SHAPE

DESCRIPCIÓN DEL PRODUCTO

BIOTIPO: HASTA 165 KG

NIVEL DE CONFORTO: BLANDO

TIPO DE ALMOHADA: EMBOLSADA INDIVIDUALMENTE

TEJIDO SUPERIOR: TEJIDO >410G/M² 100% POLIÉSTER

MATELASSE: FIBRA 100% POLIÉSTER 60 G/M² CON ESPUMA HIPERBLANDA D24 KG/M³ 1,0CM Y ESPUMA HIPERBLANDA (ULTRACEL) D24 KG/M³ 5,0CM

CAPA DE CONFORT: LATEX REST D55 KG/M³ 8,0CM EN FORMA DE COPA

O Ápice do descanso e do Bem-estar

- Alta resiliência
- Molejo ENSACADO HIGH CORE
- Preserva o sono REM



PYLOS

Design CAROLINA CARLESSO



ASSISTA O
CONCEITO
DESTE
PRODUTO

FEELING ESTOFADOS | *Coleção Cotidiano*

DESCRIÇÃO DO PRODUTO

BIOTIPO: ATE 200 KG

NIVEL DE CONFORTO: MÉDIO

TIPO DE MOLEJO: FIO CONTINUO NAO ENTRELACADO

TECIDO DO TAMPO: MALHA 410g/m² 100% POLIESTER

MATELASSÊ: FIBRA 100% POLIESTER 60 g/m² com ESPUMA VISCOELASTICA GEL D45 kg/m³ 1,0cm ESPUMA HIPERMACIA (ultracel) D24 kg/m³ 2,5cm

CAMADA DE CONFORTO: ESPUMA HIPERMACIA (ultracel) D24 kg/m³ 5,0cm
ESPUMA MACIA D36 kg/m³ 2,5cm

DESCRIPTION OF PRODUCT

BIOTYPE: UP TO 200 KG

COMFORT LEVEL: MEDIUM

CUSHION TYPE: CONTINUOUS NONWOVEN YARN

TOP FABRIC: > 410G/M² FABRIC 100% POLYESTER

MATTRESS: 100% POLYESTER FIBER 60 G/M² WITH D45 VISCOELASTIC GEL FOAM KG/M³ 1.0CM AND HYPERSOFT D24 KG/M³ 2.5CM (ULTRACEL)

COMFORT LAYER: HYPERSOFT FOAM D24 KG/M³ 5,0CM (ULTRACEL)
SOFT FOAM D36 KG/M³ 2,5CM

DESCRIPCIÓN DEL PRODUCTO

BIOTIPO: HASTA 200KG

NIVEL DE CONFORT: BLANDO

TIPO DE ALMOHADA: HILO CONTINUO NO TRENZADO

TEJIDO SUPERIOR: >TEJIDO 410G/M² 100% POLIÉSTER

MATELASSE: >FIBRA 100% POLIÉSTER 60 G/M² CON ESPUMA GEL VISCOELÁSTICO D45 KG/M³ 1,0CM Y ESPUMA HIPERBLANDA D24 KG/M³ 2,5CM (ULTRACEL)

CAPA DE CONFORT: ESPUMA DE HIPERBLANDA D24 KG/M³ 5,0CM (ULTRACEL)
ESPUMA BLANDA D36 KG/M³ 2,5CM



Suporte elevado para um sono restaurador

- Maior durabilidade
- Espuma Viscoelástica = Mais frescor
- Molejo MIRACOIL® = Suporte elevado

FARIS

Design CAROLINA CARLESSO



ASSISTA O
CONCEITO
DESTE
PRODUTO

DESCRIÇÃO DO PRODUTO

BIOTIPO: ATE 200 KG

NIVEL DE CONFORTO: MACIO

TIPO DE MOLEJO: FIO CONTINUO NAO ENTRELACADO

TECIDO DO TAMPO: MALHA 410g/m² 100% POLIESTER

MATELASSÊ: FIBRA 100% POLIESTER 60 g/m² com ESPUMA HIPERMACIA D24 kg/m³ C/GEL 2,5cm(Ultracel) e ESPUMA HIPERMACIA D24 kg/m³ 5,0cm (Ultracel)

CAMADA DE CONFORTO: LATEX D55 kg/m³ 8,0cm em FORMATO DE COPOS COM 75mm DE ESPESSURA

DESCRIPTION OF PRODUCT

BIOTYPE: UP TO 155 KG

COMFORT LEVEL: SOFT

CUSHION TYPE: CONTINUOUS NONWOVEN YARN

TOP FABRIC: > 410G/M² FABRIC 100% POLYESTER

MATTRESS: >FIBER 100% POLYESTER 60 G/M² WITH HYPERSOFT FOAM D24 KG/M³ WITH GEL 2,5CM (ULTRACEL) AND HYPERSOFT FOAM D24 KG/M³ 5,0CM (ULTRACEL)

COMFORT LAYER: >LATEX D55 KG/M³ 8,0CM IN 75MM THICK CUP SHAPE

DESCRIPCIÓN DEL PRODUCTO

BIOTIPO: HASTA 155 KG

NIVEL DE CONFORT: BLANDO

TIPO DE ALMOHADA: HILO CONTINUO NO TRENZADO

TEJIDO SUPERIOR: >TEJIDO 410G/M² 100% POLIÉSTER

MATELASSE: FIBRA 100% POLIÉSTER 60 G/M² CON ESPUMA HIPERBLANDA D24 KG/M³ CON GEL 2,5CM (ULTRACEL) Y ESPUMA IPERBLANDA D24 KG/M³ 5,0CM (ULTRACEL)

CAPA DE CONFORT: LATEX D55 KG/M³ 8,0CM EN FORMA DE COPA DE 75MM DE ESPESOR

Estabilidade e um conforto excepcional

- 5 diferentes zonas de suporte
- Resiliência (capacidade de retorno)
- Suporte elevado



ROLIMÃ

Design MAURICIO BOMFIM



ASSISTA O
CONCEITO
DESTE
PRODUTO



DESCRIÇÃO DO PRODUTO

ASSENTO: FIXO - HR + ULTRACEL + D33 + FIBA

ROLINHO: FIXO - HR + FIBRA

PÉS: PINTURA ELETROSTÁTICA - CHUMBO, MARROM OU BLACK.

OBSERVAÇÕES: A LARGURA TOTAL DO BANCO É MAIOR QUE A LARGURA DO ASSENTO COM OS ROLINHOS, DEVIDO A CURVATURA DO GAVETÃO.

DESCRIPTION OF PRODUCT

SEAT: FIXED - HR + ULTRACEL + D33 + FIBER

ROLL CUSHION: FIXED - HR + FIBER

FOOT: ELECTROSTATIC PAINTING - LEAD, BROWN OR BLACK.

NOTE: THE TOTAL WIDTH OF THE STOOL IS GREATER THAN THE WIDTH OF THE SEAT WITH THE ROLL CUSHIONS, DUE TO THE CURVATURE OF THE DRAWER.

DESCRIPCIÓN DEL PRODUCTO

ASIENTO: FIJO - HR + ULTRACEL + D33 + FIBRA

ALMOHADA ROLLITO: FIJO - HR + FIBRA

PIES: PINTURA ELECTROSTÁTICA - PLOMO, MARRÓN O NEGRO.

OBSERVACIONES: LA ANCHURA TOTAL DEL TABURETE ES MÁS GRANDE QUE LA DEL ASIENTO CON LAS ALMOHADAS ROLLITO, DEBIDO A LA CURVATURA DEL CAJÓN.

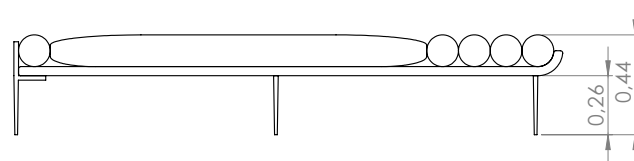

Configurações de banco

Banco 180 - 1ass(125) + 3rol(15)

Banco 200 - 1ass(130) + 4rol(15)

Banco 240 - 1ass(155) + 5rol(15)

AMBURANA

Design MAURICIO BOMFIM



ASSISTA O
CONCEITO
DESTE
PRODUTO



DESCRIÇÃO DO PRODUTO

ASSENTO: FIXO - HR + ULTRACEL + D33 + FIBRA

MESA: LÂMINA NATURAL - CARVALHO NATURAL, CARVALHO EBANIZADO, CARVALHO LINEN OU NOGUEIRA.

TINGIMENTO - TINGIMENTO NATURAL, EBANIZADO, LINEN, NOGUEIRA OU IMBUÍIA.

SUPORTE MESA: PINTURA ELETROSTÁTICA - FENDI, CHUMBO, MARROM OU BLACK.

PÉS: PINTURA ELETROSTÁTICA - FENDI, CHUMBO, MARROM OU BLACK.

LÂMINA NATURAL - CARVALHO NATURAL, CARVALHO EBANIZADO, CARVALHO LINEN OU NOGUEIRA.

DESCRIPTION OF PRODUCT

SEAT: FIXED - HR + ULTRACEL + D33 + FIBER

TABLE: NATURAL VENEER - NATURAL OAK, EBANIZED OAK, LINEN OAK OR WALNUT.

DYEING - NATURAL STAIN, EBANIZED, LINEN, WALNUT OR IMBUÍA.

TABLE STAND: ELECTROSTATIC PAINT - FENDI, LEAD, BROWN OR BLACK

FOOT: ELECTROSTATIC PAINT - FENDI, LEAD, BROWN OR BLACK.

NATURAL VENEER - NATURAL OAK, BURLLED OAK, LINEN OAK OR WALNUT.

DESCRIPCIÓN DEL PRODUCTO

ASIENTO: FIJO - HR + ULTRACEL + D33 + FIBRA

MESA: CHAPA NATURAL - ROBLE NATURAL, ROBLE ÉBANO, ROBLE LINO O NOGAL.

TEÑIDO - TINTE NATURAL, EBANIZADO, LINO, NOGAL O IMBUÍA.

SOPORTE DE MESA: PINTURA ELECTROSTÁTICA - FENDI, PLOMO, MARRÓN O NEGRO

PIES: PINTURA ELECTROSTÁTICA - FENDI, PLOMO, MARRÓN O NEGRO.

CHAPA NATURAL - ROBLE NATURAL, ROBLE BURILADO, ROBLE LINO O NOGAL.

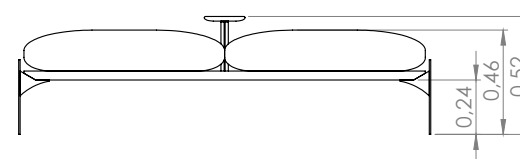
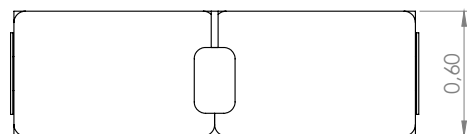

Configurações de banco

Banco 160 - 2ass(80) + 1 mesa(18)

Banco 180 - 2ass(90) + 1 mesa(18)

ROSS

Design FERNANDA POLUCHA
E NARIANA ZUANA



FEELING ESTOFADOS | *Coleção Cotidiano*

DESCRIÇÃO DO PRODUTO

ASSENTO: FIXO - D33 + D20 SOFT + FIBRA.

BASE: PINTURA ELETROSTÁTICA - CHUMBO, MARROM OU BLACK.

MESA: LÂMINA NATURAL - CARVALHO NATURAL, CARVALHO EBANIZADO, CARVALHO LINEN OU NOGUEIRA.

DETALHE: CINTO - TECIDO OU COURO.

DETALHE COSTURA: CINTO - COSTURA G

LINHA COSTURA DETALHE: BRANCO (01), VERDE (02), CAMELO (03), MARROM (04), PRETO (05), AREIA (06) OU CINZA (07).

DESCRIPTION OF PRODUCT

SEAT: FIXED - D33 + D20 SOFT + FIBER.

BASE: ELECTROSTATIC PAINT - LEAD, BROWN OR BLACK.

TABLE: NATURAL VENEER - NATURAL OAK, EBONIZED OAK, OAK LINEN OR WALNUT.

DETAIL: BELT - FABRIC OR LEATHER.

SEWING DETAIL: BELT - G SEWING

SEWING THREAD: WHITE (01), GREEN (02), CAMEL (03), BROWN (04), BLACK (05), SAND (06) OR GRAY (07).

DESCRIPCIÓN DEL PRODUCTO

ASIENTO: FIJO - D33 + D20 SUAVE + FIBRA.

BASE: PINTURA ELECTROSTÁTICA - PLOMO, MARRÓN O NEGRO.

MESA: CHAPA NATURAL - ROBLE NATURAL, ROBLE EBANIZADO, ROBLE LINO O NOGAL.

DETALLE: CINTURÓN - TELA O PIEL.

DETALLE DE LA COSTURA: CINTURÓN - COSTURA G

HILO DEL DETALLE DE LA COSTURA: BLANCO (01), VERDE (02), CAMELO (03), MARRÓN (04), NEGRO (05), ARENA (06) O GRIS (07).

ROSS

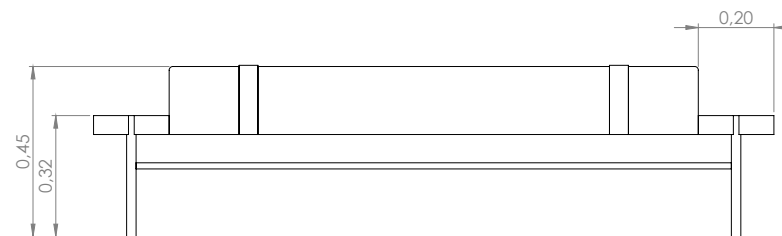

Configurações de banco

Banco 140 - 1ass(100) + 2mesas(20)

Banco 180 - 1ass(140) + 2mesas(20)

OTTIS

Design FERNANDA POLUCHA
E NARIANA ZUANA



DESCRIÇÃO DO PRODUTO

ASSENTO: FIXO - D33 + FIBRA.

PÉS: PINTURA ELETROSTÁTICA - CHUMBO, MARROM OU BLACK.

BASE: TINGIMENTO - TINGIMENTO NATURAL, EBANIZADO, NOGUEIRA, LINEN, NOZES OU IMBUÍIA.

OBSERVAÇÕES: DEBRUM E REVISTEIRO INDISPONÍVEIS NO RECOURO.

DESCRIPTION OF PRODUCT

SEAT: FIXED - D33 + FIBER.

FEET: ELECTROSTATIC PAINTING - LEAD, BROWN OR BLACK.

BASE: DYEING - NATURAL DYEING, EBANIZED, WALNUT, LINEN, WALNUT OR IMBUÍIA.

NOTES: HEM AND BOOKCASE UNAVAILABLE IN LEATHER.

DESCRIPCIÓN DEL PRODUCTO

ASIENTO: FIJO - D33 + FIBRA.

PIES: PINTURA ELECTROSTÁTICA - PLOMO, MARRÓN O NEGRO.

BASE: TINTE - TINTE NATURAL, EBANIZADO, NOGAL, LINO, NOGAL O IMBUÍIA.

OBSERVACIONES: DEBRUM Y LIBRERÍAS NO DISPONIBLES EN LA PIEL.



OTTIS

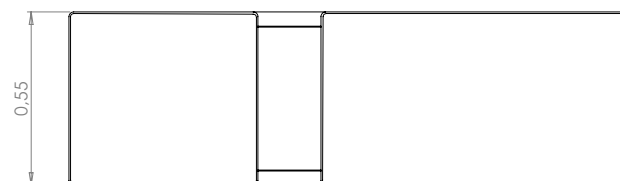
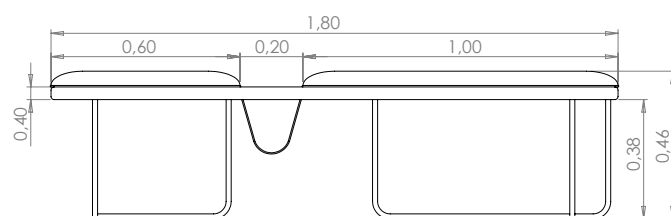

Configurações de banco

Banco 140 - 1ass(60) + 1rev(20) + 1ass(60)

Banco 180 - 1ass(60) + 1rev(20) + 1ass(100)

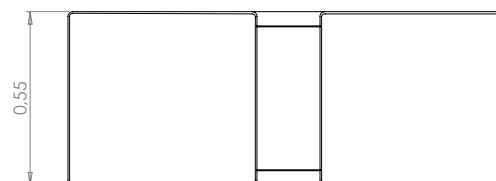
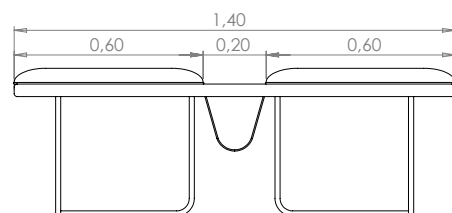

KIM

Design DANIELA FERRO



FEELING ESTOFADOS | *Coleção Cotidiano*



KIM

DESCRIÇÃO DO PRODUTO

ASSENTO: FIXO - PERCINTA + D33 + FIBRA.

BASE: TONALIZANTE - NATURAL, EBANIZADO, LINEN, NOGUEIRA, NOZES OU IMBUIA.

MESA: LÂMINA NATURAL - CARVALHO NATURAL, CARALHO EBANIZADO, CARVALHO LINEN OU NOGUEIRA.

OBSERVAÇÕES: A MESA CONTÉM 70CM DE LARGURA, PORÉM, APLICADA AO PRODUTO ELA OCUPA UM ESPAÇO DE 23CM NA CONFIGURAÇÃO FINAL.

PRODUTO INDISPONÍVEL EM MEDIDAS ESPECIAIS.

DESCRIPTION OF PRODUCT

SEAT: FIXED - ELASTIC BELT + D33 + FIBER.

BASE: TONED - NATURAL, EBANIZED, LINEN, WALNUT, WALNUT OR IMBUIA.

TABLE: NATURAL VENEER - NATURAL OAK, EBANIZED OAK, LINEN OAK OR WALNUT.

NOTE: THE TABLE CONTAINS 70CM WIDTH, HOWEVER, APPLIED TO THE PRODUCT IT TAKES UP A SPACE OF 23CM IN THE FINAL CONFIGURATION. PRODUCT UNAVAILABLE IN SPECIAL MEASURES.

DESCRIPCIÓN DEL PRODUCTO

ASIENTO: FIJO - CINTURÓN ELÁSTICO + D33 + FIBRA.

BASE: TONO - NATURAL, EBANIZADO, LINO, NOGAL, NUEZ O IMBUIA.

MESA: CHAPA NATURAL - ROBLE NATURAL, ROBLE EBANIZADO, ROBLE LINO O NOGAL.

OBSERVACIONES: LA MESA TIENE 70CM DE ANCHO, SIN EMBARGO, APLICADA AL PRODUCTO OCUPA UN ESPACIO DE 23CM EN LA CONFIGURACIÓN FINAL.

PRODUCTO NO DISPONIBLE EN MEDIDAS ESPECIALES.

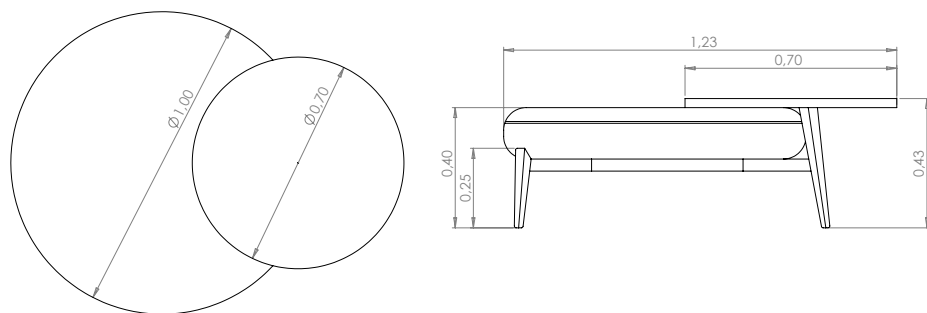

Configuração de Puff

Puff 123 - 1puff(100) + 1mesa(70)



RUBY

Design STUDIO FEELING



DESCRIÇÃO DO PRODUTO

ASSENTO: FIXO - HR + D33 + FIBRA.

PÉ/BASE: PINTURA ELETROSTÁTICA - CHUMBO, MARROM OU BLACK.

OBSERVAÇÕES: QUANDO O PUFF FOR REVESTIDO NO COURO TRANÇADO, É POSSÍVEL ENCONTRAR ALGUMAS UNIFORMIDADES POR SER TRATAR DE UM PRODUTO ARTESANAL. O COURO TRANÇADO ESTÁ DISPONÍVEL SOMENTE NA COR CINZA E NA COMBINAÇÃO OFF WHITE/CAMURÇA PRETO.



Configurações de Puff

Puff 101 - 1puff(101x94)
Puff 110 - 1puff(110x110)
Puff 121 - 1puff(121x62)
Puff 130 - 1puff(130x130)
Puff 158 - 1puff(158x50)

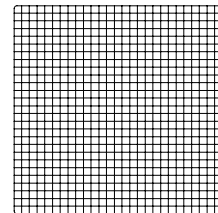

Configurações de Puff com tampo em couro trançado

Puff 101 - 1puff/CT(101x94)
Puff 110 - 1puff/CT(110x110)
Puff 121 - 1puff/CT(121x62)
Puff 130 - 1puff/CT(130x130)
Puff 158 - 1puff/CT(158x50)

DESCRIPTION OF PRODUCT

SEAT: FIXED - HR + D33 + FIBER.

FOOT/BASE: ELECTROSTATIC PAINTING - LEAD, BROWN OR BLACK.

NOTE: WHEN THE PUFF IS COVERED IN BRAIDED LEATHER, IT IS POSSIBLE TO FIND SOME UNIFORMITIES BECAUSE IT IS HANDMADE PRODUCT. THE BRAIDED LEATHER IS ONLY AVAILABLE IN GRAY AND IN THE OFF WHITE/BLACK SUEDE COMBINATION.

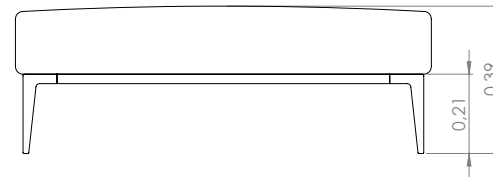

DESCRIPCIÓN DEL PRODUCTO

ASIENTO: FIJO - HR + D33 + FIBRA.

PIE/BASE: PINTURA ELECTROSTÁTICA - PLOMO, MARRÓN O NEGRO.

OBSERVACIONES: CUANDO EL PUFF SE RECUBRE DE PIEL TRENZADO, ES POSIBLE ENCONTRAR ALGUNAS UNIFORMIDADES PORQUE ES UN PRODUCTO HECHO A MANO.

LA PIEL TRENZADA SÓLO ESTÁ DISPONIBLE EN GRIS Y EN LA COMBINACIÓN DE OFF WHITE/ANTE NEGRO.

OTTO

Design STUDIO FEELING



DESCRIÇÃO DO PRODUTO

OTTO

ASSENTO: FIXO - PERCINTA + D33 + FIBRA.

BASE: PINTURA ELETROSTÁTICA - CHUMBO, MARROM OU BLACK.

OBSERVAÇÕES: REVESTIMENTO DE COURO

INDISPONÍVEL PARA AS CONFIGURAÇÕES DE PUFF LISO.

REVESTIMENTO DE TECIDO INDISPONÍVEL PARA AS CONFIGURAÇÕES DE PUFF QUADRICULADO.

DESCRIPTION OF PRODUCT

OTTO

SEAT: FIXED - ELASTIC BELT + D33 + FIBER.

BASE: ELECTROSTATIC PAINTING - LEAD, BROWN OR BLACK.

NOTE: LEATHER COVERING UNAVAILABLE

FOR SMOOTH PUFF CONFIGURATIONS.

FABRIC COVERING UNAVAILABLE FOR CHECKERED PUFF CONFIGURATIONS.

DESCRIPCIÓN DEL PRODUCTO

OTTO

ASIENTO: FIJO - PERCUSIÓN + D33 + FIBRA.

BASE: PINTURA ELECTROSTÁTICA - PLOMO, MARRÓN O NEGRO.

OBSERVACIONES: REVESTIMIENTO DE PIEL NO DISPONIBLE PARA LAS CONFIGURACIONES PUFF LISO.

REVESTIMIENTO DE TELA NO DISPONIBLE PARA LAS CONFIGURACIONES DE PUFF CUADRICULADO.

OTTO

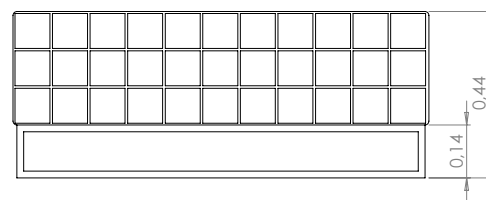
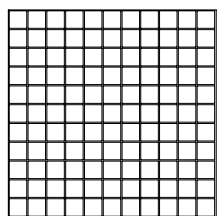

Configurações de Puff quadriculado

Puff quad 62 - 1puff(62x62)
Puff quad 110 - 1puff(110x110)
Puff quad 121 - 1puff(121x62)
Puff quad 146 - 1puff(146x146)

Configurações de Puff liso

Puff liso 62 - 1puff(62x62)
Puff liso 110 - 1puff(110x110)
Puff liso 121 - 1puff(121x62)
Puff liso 146 - 1puff(146x146)



EROS

Design STUDIO FEELING



DESCRIÇÃO DO PRODUTO

ASSENTO: FIXO - PERCINTA + D33 + FIBRA.

PÉ FIXO: IMBUÍDA.

PÉ GIRATÓRIO: RODÍZIO.

OPCIONAIS: PÉ FIXO OU GIRATÓRIO.

OBSERVAÇÕES: REVESTIMENTO DE COURO

INDISPONÍVEL PARA AS CONFIGURAÇÕES DE PUFF LISO.

REVESTIMENTO DE TECIDO INDISPONÍVEL PARA AS CONFIGURAÇÕES DE

PUFF QUADRICULADO.

DESCRIPTION OF PRODUCT

SEAT: FIXED - ELASTIC BELT + D33 + FIBER.

FIXED FOOT: IMBUÍDA.

ROTATING FOOT: CASTER.

OPTIONAL: FIXED OR ROTATING BASE.

NOTE: LEATHER COVERING UNAVAILABLE

FOR SMOOTH PUFF CONFIGURATIONS.

FABRIC COVERING UNAVAILABLE FOR CHECKERED PUFF CONFIGURATIONS.

DESCRIPCIÓN DEL PRODUCTO

ASIENTO: FIJO - CINTURÓN ELÁSTICO + D33 + FIBRA.

PIE FIJO: IMBUÍDA.

PIE GIRATORIO: RUEDA.

OPCIONAL: PIE FIJO O GIRATORIO.

OBSERVACIONES: REVESTIMIENTO DE PIEL NO DISPONIBLE PARA LAS

CONFIGURACIONES PUFF LISO.

REVESTIMIENTO DE TELA NO DISPONIBLE PARA LAS CONFIGURACIONES DE

PUFF CUADRICULADO.

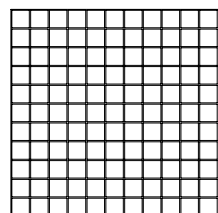

Configurações de Puff quadriculado

Puff quad 62 - 1puff(62x62)

Puff quad 110 - 1puff(110x110)

Puff quad 121 - 1puff(121x62)

Puff quad 146 - 1puff(146x146)

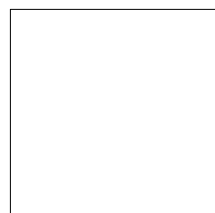

Configurações de Puff liso

Puff liso 62 - 1puff(62x62)

Puff liso 110 - 1puff(110x110)

Puff liso 121 - 1puff(121x62)

Puff liso 146 - 1puff(146x146)

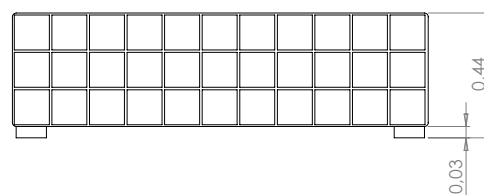

EROS



INFORMAÇÕES

INFORMATION

INFORMACIONES



CARACTERÍSTICAS DA ULTRACEL

ESPUMA DIFERENCIADA, PROPORCIONA ELEVADÍSSIMA DURABILIDADE E MACIEZ. COM COEFICIENTE DE DEFORMAÇÃO PRÓXIMO A ZERO*

* CONFORME TESTE, ONDE A ESPUMA FOI COLOCADA EMBAIXO DO PNEU DE UM AUTOMÓVEL POR 12 HORAS E MANTEVE 100% DO FORMATO ORIGINAL

ULTRACEL CHARACTERISTICS

DIFFERENTIATED FOAM THAT PROVIDES HIGH DURABILITY AND SOFTNESS. WITH NEAR ZERO DEFORMATION COEFFICIENT

* AS TESTED, WHERE THE FOAM WAS PLACED UNDER AN CAR'S TIRE FOR 12 HOURS AND KEPTED 100% OF ORIGINAL FORMAT

CARACTERÍSTICAS DE ULTRACEL

ESPUMA DIFERENCIADA, LE PROPORCIONA UNA ALTÍSSIMA DURABILIDAD Y FLEXIBILIDAD. TIENE UN COEFICIENTE DE DEFORMACIÓN CERCANO A CERO.

* SEGÚN LAS PRUEBAS TÉCNICAS, LA ESPUMA FUE PUESTA DEBAJO DEL PNEUMÁTICO DE UN AUTOMÓVIL POR 12 HORAS Y SE MANTUVE AL 100% DEL FORMATO ORIGINAL

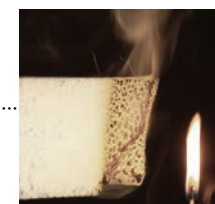
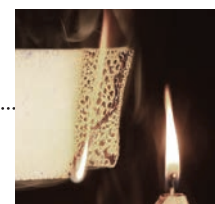

ESPUMAS ANTICHAMA

AS ESPUMAS DE POLIURETANO UTILIZADAS PELA FEELING EM SUA LINHA DE PRODUTOS, POSSUEM UM TRATAMENTO QUÍMICO QUE AS TORNAM AUTOEXTINGUÍVEIS (ANTICHAMA), OU SEJA, AO SEREM EXPOSTAS AO FOGO, TEM A VELOCIDADE DE QUEIMA RETARDADA DE FORMA ELEVADA, E QUANDO A CHAMA É RETIRADA, O FOGO NA ESPUMA SE EXTINGUE. É IMPORTANTE RESSALTAR QUE OS TECIDOS, AS FIBRAS, AS PERCINTAS ELÁSTICAS, A ESTRUTURA DE MADEIRA E DEMAIS ITENS QUE FAZEM PARTE DA CONSTRUÇÃO DESTE PRODUTO, NÃO POSSUEM ESTA CARACTERÍSTICA, DEVENDO POR ISTO SE EVITAR SEMPRE A PROXIMIDADE DESTE SOFÁ COM CHAMAS ABERTAS, CIGARROS, ETC. DE QUALQUER FORMA, CASO OCORRA UM SINISTRO, A VELOCIDADE DE PROPAGAÇÃO DAS CHAMAS SERÁ DIMINUÍDA DE FORMA SENSÍVEL, O QUE FACILITARÁ A SUA EXTINGUIÇÃO.

FOAM EXTRUDED

POLYURETHANE FOAMS USED BY FEELING ESTOFADOS IN ITS PRODUCT LINE, HAVE A CHEMICAL TREATMENT THAT MAKES THEM SELF-EXTINGUISHED (ANTI-FLAME), OR WHEN EXPOSED TO FIRE, THE BURNING RATE SLOW DOWN, AND WHEN THE FLAME IS REMOVED THE FIRE IS EXTINGUISHED FROM THE FOAM. VERY IMPORTANT, THE FABRICS, THE FIBERS, THE ELASTIC BELTS, THE TIMBER AND OTHER ITEMS THAT ARE PART OF THE CONSTRUCTION OF THESE PRODUCTS, DO NOT HAVE THIS FEATURES, SO SHOULD BE AVOIDED WHENEVER THE CLOSENESS OF THIS SOFAS WITH OPEN FLAMES LIKE CIGARETTES, ETC. ANYWAY, IN CASE OF AN ACCIDENT, THE SPEED OF PROPAGATION OF THE FLAME WILL BE DIMINISHED CONSIDERABLY, THAT WILL FACILITATE ITS EXTINGUISHMENT

ESPUMAS ANTILLAMA

LAS ESPUMAS DE POLIURETANO UTILIZADAS PELA FEELING EM SU LÍNEA DE PRODUCTOS TIENEN UN TRATAMIENTO QUÍMICO QUE LAS TORNAN AUTO-EXTINGUIBLES (ANTI-LLAMA), O SEA, AL EXPONERLAS AL FUEGO, TIENEN LA VELOCIDAD DE QUEMA RETARDADA DE FORMA ELEVADA, Y CUANDO LA LLAMA SE ÉS RETIRADA, EL FUEGO EN LA ESPUMA SE APAGA. ÉS IMPORTANTE RESSALTAR QUE LOS TEJIDOS, LAS FIBRAS, LOS CINTURONES ELÁSTICOS, LAS ESTRUCTURA DE MADERA Y LOS DEMÁS ITENS QUE HACEN PARTE DE LA CONSTRUCCIÓN DE ESTE PRODUCTO, NO POSEEN ESTA CARACTERÍSTICA, DEBIENDO POR ESO EVITARSE SIEMPRE LA PROXIMIDAD DE ESTE SOFÁ CON LLAMAS ABIERTAS, CIGARRILLOS, ETC. DE CUALESQUIER FORMA, EN EL CASO DE OCURRIR UN SINISTRO, LA VELOCIDAD DE PROPAGACIÓN DE LAS LLAMAS SERÁ DISMINUIDA DE FORMA SENSIBLE, LO QUE FACILITARÁ SU EXTINGUISHMENT.

NOTA IMPORTANTE: Partes do processo de fabricação dos estofados são artesanais, portanto, podem ocorrer pequenas variações de 2 cm para mais ou para menos nas dimensões apresentadas nesse catálogo.

INFORMAÇÕES

INFORMATION

INFORMACIONES

Costura A

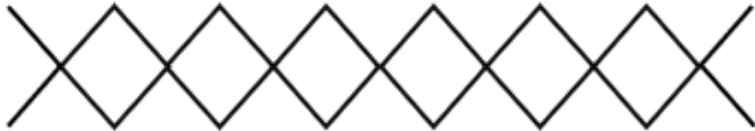

Costura B



Costura C



Costura D

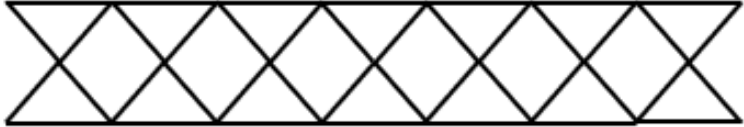

Costura E

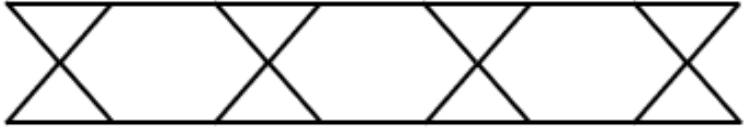

Costura F



Costura G

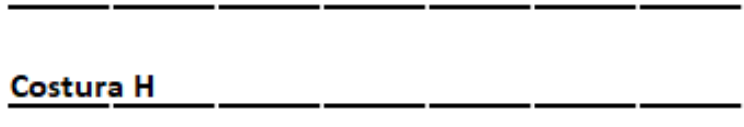

Costura H



- TECIDOS FORNECIDOS ESTAMPADOS, FAZ-SE NECESSÁRIO O ENVIO COM 20% A MAIS DO QUE A METRAGEM INDICADA.

- NÃO RECOMENDAMOS REVESTIMENTO DE COURO E/OU COURÍSSIMO EM PRODUTOS ARTICULADOS, POIS, O MESMO PODE DANIFICAR-SE COM O TEMPO NOS PONTOS EM QUE O PRODUTO SOFRE ATRITO DEVIDO AO MOVIMENTO.

- QUANDO REVESTIDO EM COURO, DEVIDO AO LIMITE DO TAMANHO DA PELE, OS PRODUTOS PODERÃO CONTER COSTURAS ADICIONAIS EM ALGUMAS DE SUAS PARTES.

- O RECOURO ESTÁ DISPONÍVEL APENAS PARA REVESTIMENTO DE DETALHES E ACABAMENTOS, NÃO SENDO POSSÍVEL REVESTIR UM ESTOFADO POR COMPLETO.

- FABRICS SUPPLIED PRINTED, MUST BE SET WITH 20% MORE THAN THE INDICATED SIZE.

- WE DO NOT RECOMMEND COVERING LEATHER AND/OR LEATHER IN ARTICULATED PRODUCTS, AS IT CAN BE DAMAGED OVER TIME AT POINTS WHERE THE PRODUCT UNDERGOES FRICTION DUE TO MOVEMENT.

- WHEN COVERED IN LEATHER, DUE TO THE SKIN SIZE LIMIT, THE PRODUCTS MAY CONTAIN ADDITIONAL SEAMS ON SOME OF ITS PARTS.

- LEATHER IS ONLY AVAILABLE FOR COVERING DETAILS AND FINISHES, IT IS NOT POSSIBLE TO COVER UPHOLSTERY COMPLETELY.

- LAS TELAS SUMINISTRADAS ESTAMPADAS, ES NECESSARIO ENVIAR COM UN 20% MÁS DE LA TALLA INDICADA.

- NO RECOMENDAMOS CUBRIR CUERO Y/O CUERO EN PRODUCTOS ARTICULADOS, YA QUE PUEDE DANARSE CON EL TIEMPO EN PUNTOS DONDE EL PRODUCTO SUFRE FRICCIONES POR MOVIMIENTO

- CUANDO ESTÁN CUBIERTOS DE CUERO, DEBIDO AL LÍMITE DE TAMAÑO DE LA PIEL, LOS PRODUCTOS PUEDEN CONTENER COSTURAS ADICIONALES EN ALGUNAS DE SUS PARTES.

- LA PIEL SOLO ESTÁ DISPONIBLE PARA CUBRIR DETALLES Y ACABADOS NO ES POSIBLE CUBRIR LA TAPICERÍA POR COMPLETO.

ACABAMENTOS

OPÇÕES DE ACABAMENTO EM PINTURA ELETROSTÁTICA



MARROM



CHUMBO



BLACK

OPÇÃO DE POLIMENTO

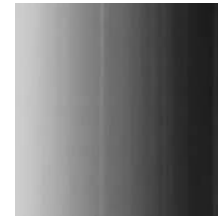

ALUMÍNIO

OPÇÕES DE ACABAMENTO EM PINTURA LACA



PRETO

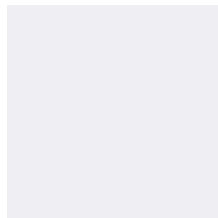

BRANCO



NUDE

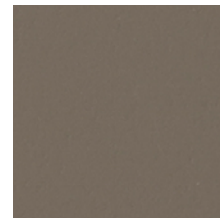

FENDI

OPÇÕES DE ACABAMENTO EM PORCELANATO

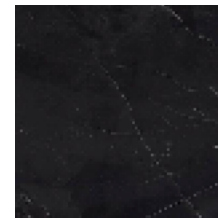

DARK



PARANA SOFT

OPÇÕES DE ACABAMENTO EM TINGIMENTO

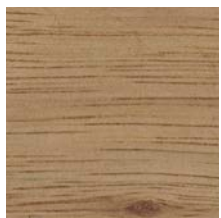

TINGIMENTO
NATURAL

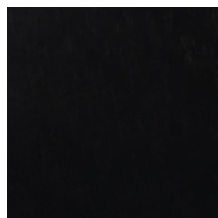

EBANIZADO

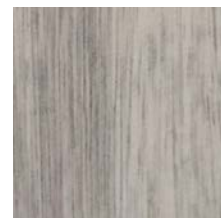

LINEN

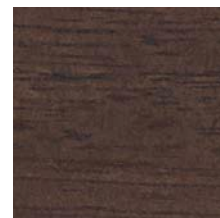

TINGIMENTO
NOGUEIRA

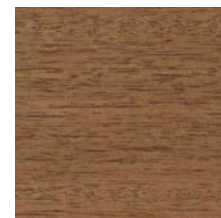

NOZES

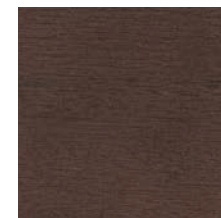

IMBUIA

OPÇÕES DE ACABAMENTO EM LAMINA NATURAL

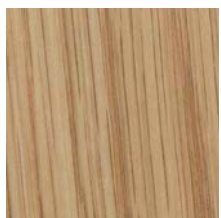

CARVALHO
NATURAL

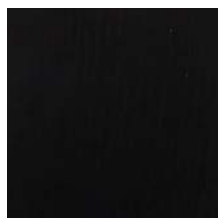

CARVALHO
EBANIZADO



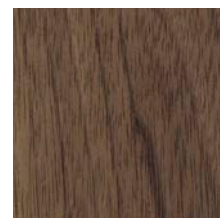

CARVALHO
LINEN



NOGUEIRA

- PODE OCORRER PEQUENA VARIAÇÃO DE COR DEVIDO O PROCESSO DE IMPRESSÃO
- SLIGHT VARIATION IN COLOR DUE TO THE PRINTING PROCESS CAN OCCUR
- PUEDE PASAR UNA PEQUEÑA VARIACIÓN DE COLOR DEBIDO AL PROCESO DE IMPRESIÓN

Jaraguá do Sul - SC - Brasil • (47) 3376-9300 •   *feelingestofados*

www.feelingestofados.com.br